

YSI incorporated



6-SERIES DRINKING WATER SYSTEMS

600DW-B Sonde
6920DW Sonde
650 MDS Display/Logger
6500 Process Monitor



Environmental Monitoring Systems



SAFETY NOTES

TECHNICAL SUPPORT AND WARRANTY INFORMATION

Contact information for technical support and warranty information on YSI's Environmental Monitoring Systems products can be found in **Section 8, Warranty and Service Information**.

COMPLIANCE

When using the YSI 6-Series sondes in a European Community (CE) country, please be aware that electromagnetic compatibility (EMC) performance issues may occur under certain conditions, such as when the sonde is exposed to certain radio frequency fields.

If you are concerned with these issues, consult the Declaration of Conformity that was enclosed with your instrument. Specific conditions where temporary sensor problems may occur are listed in this document.

If you are unable to locate the Declaration of Conformity that was shipped with your instrument, contact your local YSI representative, or YSI Customer Service in Yellow Springs, Ohio for a copy of the document. See **Section 8, Warranty and Service Information** for contact information.

SPECIFICATIONS

For general specifications for all YSI Environmental Monitoring Systems products included in this manual, please see **Appendix M, Specifications**.

GENERAL SAFETY CONSIDERATIONS

For Health and Safety issues concerning the use of the calibration solutions with the sondes, please see **Appendix A, Health and Safety**.

NOTICE

Information contained in this manual is subject to change without notice. Effort has been made to make the information contained in this manual complete, accurate, and current. YSI shall not be held responsible for errors or omissions in this operations manual.

WARNING:

When caring for your sonde, remember that the sonde is sealed at the factory, and there is never a need to gain access to the interior circuitry of the sonde. In fact, if you attempt to disassemble the sonde, you would void the manufacturer's warranty.

TABLE OF CONTENTS

SECTION 1 INTRODUCTION	
1.1 ABOUT YSI	1-1
1.2 HOW TO USE THIS MANUAL	1-1
1.3 UNPACKING AND INSPECTION	1-2
SECTION 2 6920DW AND 600DW-B SONDES	
2.1 GETTING STARTED	2-1
2.2 CONNECTING YOUR SONDE	2-2
2.3 PREPARING THE SONDE FOR USE	2-5
2.4 ECOWATCH FOR WINDOWS – GETTING STARTED	2-18
2.5 SONDE SOFTWARE SETUP	2-18
2.6 GETTING READY TO CALIBRATE	2-26
2.7 TAKING READINGS	2-39
2.8 USING ECOWATCH TO UPLOAD AND ANALYZE DATA	2-45
2.9 SONDE MENU	2-59
2.10 CARE, MAINTENANCE, AND STORAGE	2-95
SECTION 3 650 MDS DATA LOGGER	
3.1 INTRODUCTION	3-1
3.2 GETTING STARTED	3-1
3.3 SETTING UP THE 650	3-18
3.4 SONDE MENU INTERFACE	3-21
3.5 LOGGING DATA WITH THE 650	3-27
3.6 MANAGING 650 FILES	3-46
3.7 UPLOADING DATA FROM SONDES	3-51
3.8 USING GPS WITH 650	3-51
3.9 USING THE 650 BAROMETER	3-53
3.10 UPGRADING 650 SOFTWARE	3-55
3.11 TROUBLESHOOTING	3-56
3.12 FERRITE BEAD INSTALLATION	3-57
3.13 SAFETY CONSIDERATIONS	3-58
3.14 650 MDS SPECIFICATIONS	3-61
SECTION 4 ECOWATCH FOR WINDOWS	
4.1 INTRODUCTION	4-1
4.2 DATA ACQUISITION AND ANALYSIS	4-7
4.3 ECOWATCH MENU	4-12
SECTION 5 PRINCIPLES OF OPERATION	
5.1 CONDUCTIVITY	5-1
5.2 SALINITY	5-2
5.3 TOTAL DISSOLVED SOLIDS (TDS)	5-2
5.4 OXIDATION REDUCTION POTENTIAL (ORP)	5-3
5.5 pH	5-4
5.6 TEMPERATURE	5-5
5.7 FREE CHLORINE	5-5
5.8 NITRATE	5-9
5.9 AMMONIUM AND AMMONIA	5-10
5.10 CHLORIDE	5-12
5.11 TURBIDITY	5-14
5.12 CHLOROPHYLL	5-16
5.13 RHODAMINE WT	5-23

SECTION 6 TROUBLE SHOOTING	
6.1 CALIBRATION ERRORS	6-1
6.2 SONDE COMMUNICATION PROBLEMS	6-2
6.3 SENSOR PERFORMANCE PROBLEMS	6-3
SECTION 7 COMMUNICATION	
7.1 OVERVIEW	7-1
7.2 HARDWARE INTERFACE	7-1
7.3 RS-232 INTERFACE	7-2
7.4 SDI-12 INTERFACE	7-2
SECTION 8 WARRANTY AND SERVICE INFORMATION	
8.1 LIMITATIONS OF WARRANTY	8-1
8.2 AUTHORIZED SERVICE CENTERS	8-2
8.3 CLEANING INSTRUCTIONS	8-2
APPENDIX A HEALTH AND SAFETY	A-1
APPENDIX B REQUIRED NOTICE	B-1
APPENDIX C ACCESSORIES AND CALIBRATION STANDARDS	C-1
APPENDIX D EMC PERFORMANCE	D-1
APPENDIX E SPECIFICATIONS	E-1
APPENDIX F QUICK START GUIDE TO DRINKING WATER APPLICATIONS	F-1
APPENDIX G USING YOUR DW SONDE WITH A YSI 6500 PROCESS MONITOR	G-1
APPENDIX H FREQUENTLY ASKED QUESTION ABOUT DW SYSTEMS	H-1

SECTION 1 INTRODUCTION

1.1 ABOUT YSI INCORPORATED

From a three-man partnership in the basement of the Antioch College science building in 1948, YSI has grown into a commercial enterprise designing and manufacturing precision measurement sensors and control instruments for users around the world. Although our range of products is broad, we focus on four major markets: water testing and monitoring, health care, bioprocessing, and OEM temperature measurement.

In the 1950s, Hardy Trolander and David Case made the first practical electronic thermometer using a thermistor. This equipment was developed to supply Dr. Leland Clark with a highly sensitive and precise temperature sensor for the original heart-lung machine. The collaboration with Dr. Clark has been critical to the success of the company. In the 1960s, YSI refined a Clark invention, the membrane covered polarographic electrode, and commercialized oxygen sensors and meters which revolutionized the way dissolved oxygen was measured in wastewater treatment plants and environmental water. Today, geologists, biologists, environmental enforcement personnel, officials of water utilities and fish farmers recognize us as the leader in dissolved oxygen measurement.

In the 1970s, YSI again worked with Clark to commercialize one of his many inventions, the enzyme membrane. This development resulted in the first practical use of a biosensor, in the form of a membrane based on immobilized glucose oxidase, to measure blood sugar accurately and rapidly. In the next few years, this technology was extended to other enzymes, including lactate oxidase for applications in biotechnology, health care, and sports medicine.

In the early 1990s, YSI launched a line of multi-parameter water monitoring systems to address the emerging need to measure non-point source pollution. Today we have thousands of instruments in the field that operate with the push of a button, store data in memory, and communicate with computers. These instruments (described in this manual) are ideal for profiling and monitoring water conditions in industrial and wastewater effluents, lakes, rivers, wetlands, estuaries, coastal waters, and monitoring wells. If the instrument has 'on board' battery power, it can be left unattended for weeks at a time with measurement parameters sampled at your setup interval and data securely saved in the unit's internal memory. The fast response of YSI's sensors make the systems ideal for vertical profiling, and the small size of some of our sondes allows them to fit down 2-inch diameter monitoring wells. All of YSI's multi-parameter systems for surface and groundwater feature the YSI-patented Rapid Pulse Dissolved Oxygen Sensor, which exhibits low-stirring dependence and provides accurate results without an expensive, bulky, and power-intensive stirrer.

YSI has established a worldwide network of selling partners in 54 countries that includes laboratory supply dealers, manufacturers' representatives, and YSI's sales force. A subsidiary, YSI UK, distributes products in the United Kingdom, a sales office in Hong Kong supports YSI's distribution partners in Asia Pacific, and YSI Japan supports distribution partners in Japan.

Through an employee stock ownership plan (ESOP), every employee is one of the owners. In 1994, the ESOP Association named YSI the ESOP Company of the Year. YSI is proud of its products and are committed to meeting or exceeding customers' expectations.

1.2 HOW TO USE THIS MANUAL

The manual is organized to let you quickly understand and operate the YSI 6-Series drinking water (DW) systems. However, it cannot be stressed too strongly that informed and safe operation is more than just

knowing which buttons to push. An understanding of the principles of operation, calibration techniques, and system setup is necessary to obtain accurate and meaningful results.

Because of the many features, configurations and applications of these versatile products, some sections of this manual may not apply to the specific system you have purchased.

If you have any questions about this product or its application, please contact YSI's customer service department or authorized dealer for assistance. See **Section 8, Warranty and Service Information** for contact information.

1.3 UNPACKING AND INSPECTION

Inspect the outside of the shipping box for damage. If any damage is detected, contact your shipping carrier immediately. Remove the equipment from the shipping box. Some parts or supplies are loose in the shipping box so check the packing material carefully. Check off all of the items on the packing list and inspect all of the assemblies and components for damage.

If any parts are damaged or missing, contact your YSI representative immediately. If you purchased the equipment directly from YSI, or if you do not know from which YSI representative your equipment was purchased, refer to **Section 8, Warranty and Service Information** for contact information.

SECTION 2 6920DW AND 600DW-B SONDES

2.1 GETTING STARTED

The 6920DW and 600DW-B-B Drinking Water Monitoring Systems are multi-parameter, water quality measurement, and data collection systems. Their primary application is the monitoring of drinking water using a flow cell and a free chlorine sensor is provided with each instrument since this parameter is very important in assessing the quality of drinking water. However, these instruments can also be used in a variety of research, assessment, and regulatory compliance applications without a flow cell as long as the user realizes that the performance of the free chlorine sensor will be significantly compromised under these conditions. The primary difference between the “DW” instruments and those provided by YSI for surface and ground water applications is that the oxygen sensor for the standard sondes has been replaced by a free chlorine sensor in the 6920DW and 600DW-B. The free chlorine sensor also requires a different circuit board which is resident in the instrument and this means that “DW” sondes are not capable of dissolved oxygen measurement and, *vice versa*, standard sondes are not capable of free chlorine measurement even though the probes themselves will fit in either of the instruments. Section 2 concentrates on how to set up operate the “DW” sondes. For the purpose of terminology in this manual it should be realized that a sonde is a torpedo-shaped water quality monitoring device that is placed in the water to gather water quality data. Sondes may have multiple probes. Each probe may have one or more sensors that read water quality data.

The following list contains parameters that your sonde may measure. See **Appendix E Specifications** for the specific parameters of each sonde.

- Free Chlorine
- Conductivity
- Specific Conductance
- Salinity
- Total Dissolved Solids
- Resistivity
- Temperature
- pH
- ORP
- Turbidity
- Nitrate-N
- Ammonia-N
- Ammonium-N
- Chloride
- Chlorophyll
- Rhodamine WT

This section is designed to quickly familiarize you with the hardware and software components of the “DW” sondes and their accessories. You will then proceed to probe installations, cable connections, software installation and finally basic communication with your Sonde. Diagrams, menu flow charts and basic written instructions will guide you through basic hardware and software setup.

2.2 CONNECTING YOUR SONDE

There are a number of ways in which you may connect the sondes to various computers, data collection devices and VT-100 terminal emulators. To utilize the configuration that will work best for your application, make sure that you have all of the components that are necessary. The following list and diagrams provide a few possible configurations.

- ❑ Sonde to Lab Computer (recommended for initial setup)
- ❑ Sonde to Data Collection Platform
- ❑ Sonde to Portable Computer
- ❑ Sonde to YSI 650 MDS Display/Logger

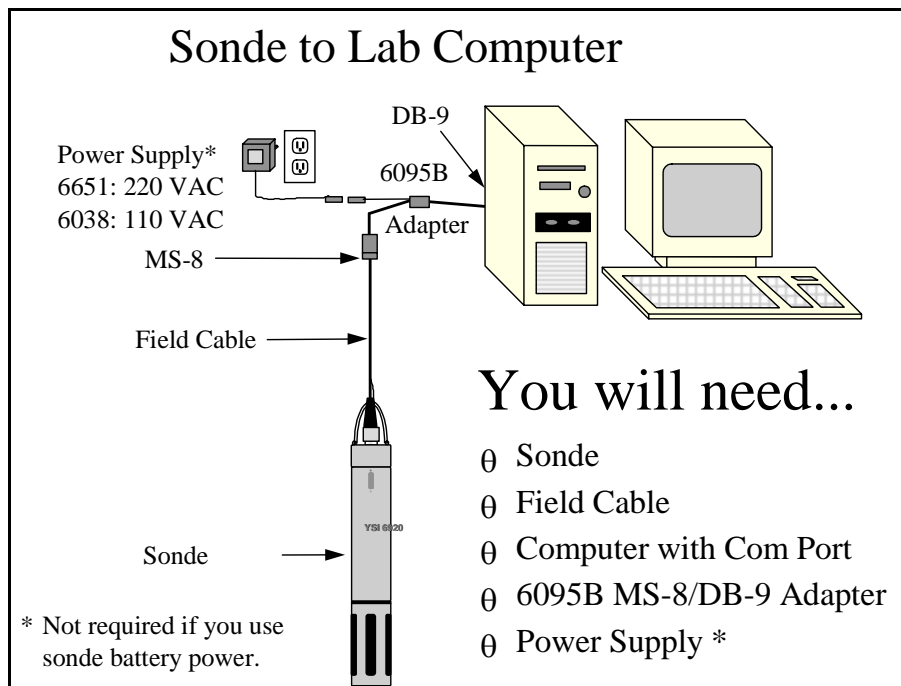

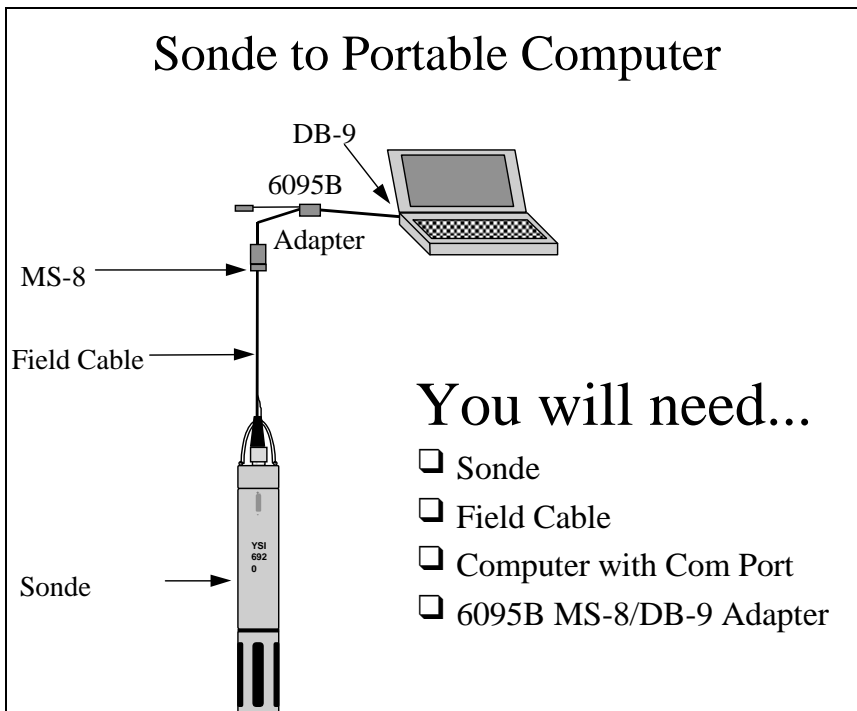
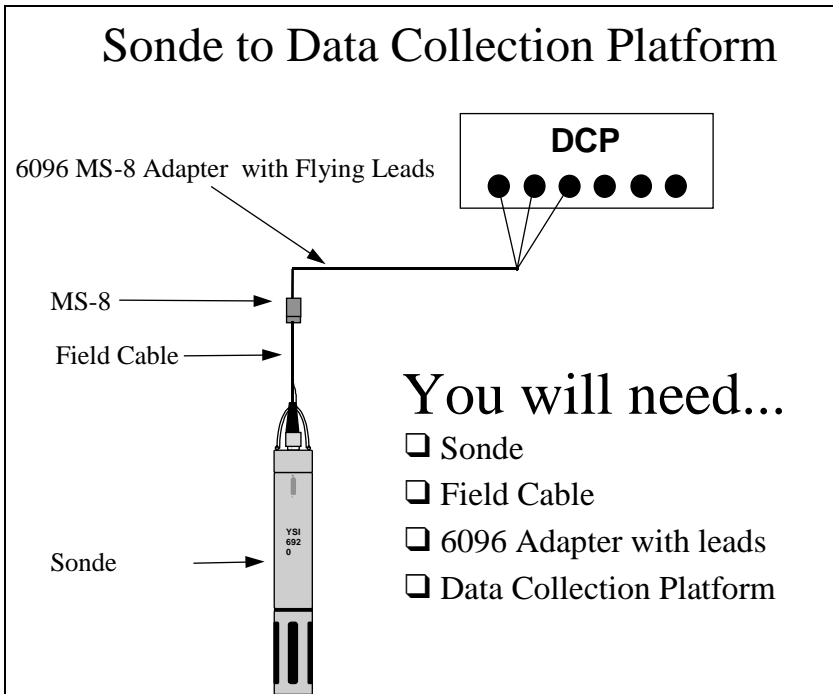

Sonde to 650 Display/Logger

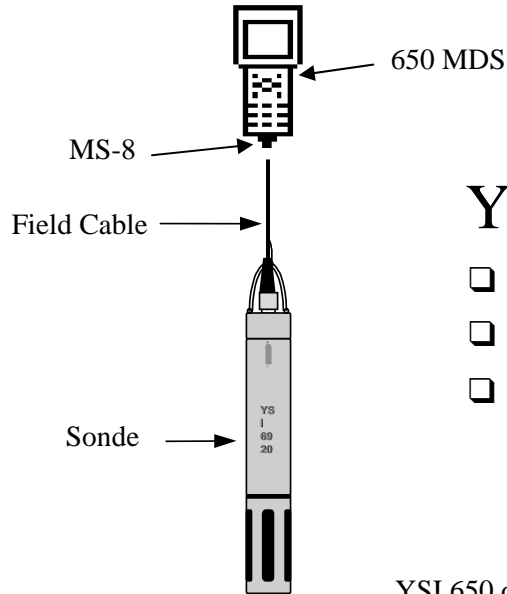

You will need...

- Sonde
- Field Cable
- 650 MDS Display/Logger

YSI 650 operates on C-cells or rechargeable batteries.

Sonde to 6500 Process Monitor



You will need...

- Sonde
- Field Cable
- 650 MDS Display/Logger



YSI 6500 operates on 90-230 V AC Power.

2.3 PREPARING THE SONDE FOR USE

To prepare the sonde for calibration and operation, you need to install probes (sensors) into the connectors on the sonde bulkhead. In addition to probe installation, you need to install a new membrane on the YSI 6572 Free Chlorine Probe. It is highly recommended that you install the free chlorine membrane before installing the probe onto the bulkhead. The next step is providing power for the sondes, through batteries or AC, and then connecting a cable. The four steps necessary for getting your sonde ready for use are listed below.

- Step 1 Installing the Free Chlorine Membrane – Section 2.3.1
- Step 2 Installing the Probes – Section 2.3.2
- Step 3 Supplying Power – Section 2.3.3
- Step 4 Connecting a Cable – Section 2.3.4

2.3.1 STEP 1 - INSTALLING THE FREE CHLORINE PROBE MEMBRANE

The 6572 Free Chlorine probe is shipped with a protective cap on the sensor tip which must be removed before proceeding. Handle the probe with care. It is very important not to drop the probe and/or gouge the probe tip. See **Section 2.10.2, Probe Care and Maintenance**, for information on how often the membrane should be replaced.

Unpack the YSI 6572 Free Chlorine Probe Kit and follow the instructions below.

FREE CHLORINE SENSOR ELECTROLYTE PREPARATION

Open the 6573 membrane kit which was shipped with your instrument and prepare the electrolyte solution. Dissolve the KCl in the dropper bottle by filling it to the neck with deionized or distilled water and shaking until the solids are fully dissolved. After the KCl is dissolved, wait a few minutes until the solution is free of bubbles.

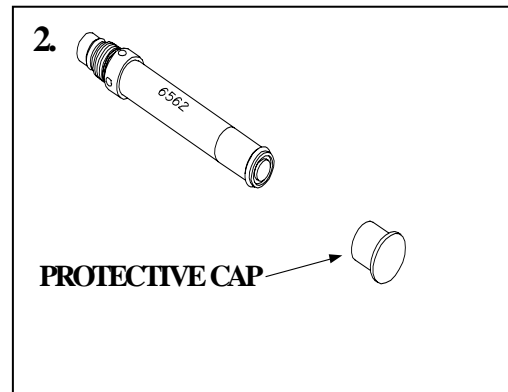
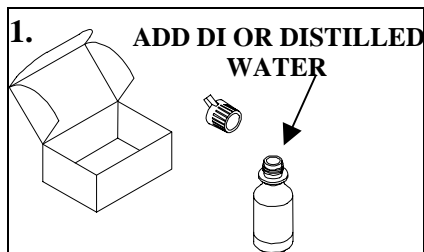

FREE CHLORINE SENSOR MEMBRANE INSTALLATION

Remove the protective Teflon membrane and O-ring from the sensor end of the YSI 6572 Free Chlorine probe. **CAUTION: The Teflon membrane MUST be removed for proper sensor function.**

Remove the protective cap is installed on the connector end of the probe.

Locate the 6035 Reconditioning Kit which was supplied with your 6572 Free Chlorine Probe. Use one of circular sanding disks the 6035 Reconditioning Kit to sand the face of the 6572 Probe according to the following instructions.

- Hold the probe in a vertical position, place a sanding disk under your thumb, and stroke the probe face in a direction parallel to the platinum electrode (located between the two silver electrodes). The motion is similar to that used in striking a match. Usually 10-15 strokes of the sanding disk are sufficient to remove black deposits on the silver electrodes. However, in extreme cases, more sanding may be required to regenerate the original silver surface.
- Rinse the probe tip well with purified water to remove dust from sanding.

CAUTION: You must sand your free chlorine sensor as described above prior to installing a membrane to insure the surface tension for probe surface/membrane interface.

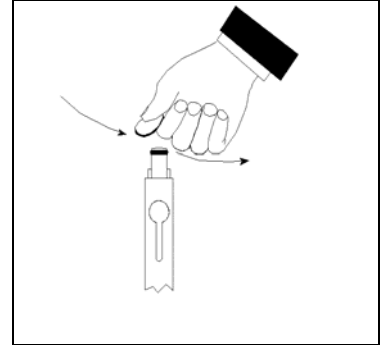

Locate the YSI 6574 O-ring Installation Kit which was shipped with your sonde. Note that the kit contains two items – a circular plate with a threaded hole and a cylindrical tool with a screwdriver-style handle as shown in the picture below.



Thread the nut on the end of the 6572 probe into the base plate as shown in the picture below.



Place an o-ring from the 6573 membrane kit in the groove at the bottom of the tool as shown in the picture below left.

Apply a few drops of KCl solution to the tip of the probe as shown in the picture above right. The fluid should completely fill the small moat around the electrodes and form a meniscus on the tip of the sensor.

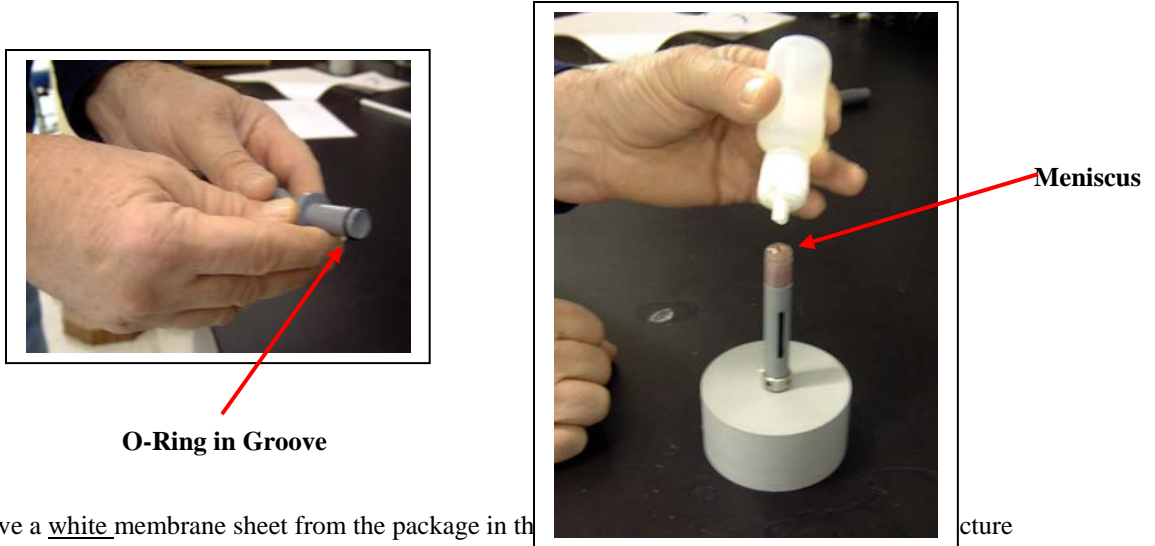

Remove a white membrane sheet from the package in the picture below.

CAUTION: The blue sheets are simply protective spacers and CANNOT be used as membranes for the free chlorine sensor.

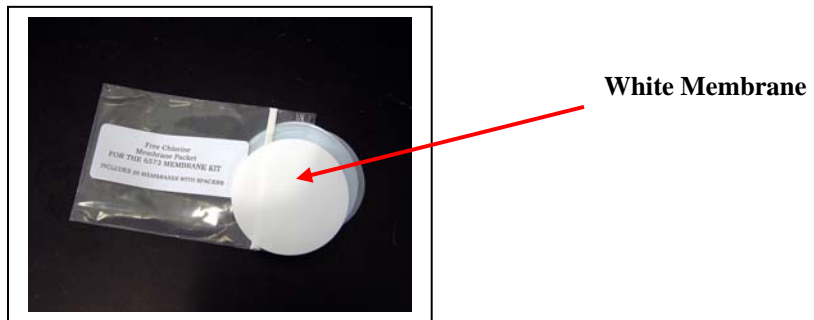

As shown in the pictures below, lay the membrane on the probe tip that contains the electrolyte so that the probe tip is approximately in the middle of the membrane.



As shown in the picture below, place the bottom of the o-ring installation tool over membrane/probe face and press down securely.

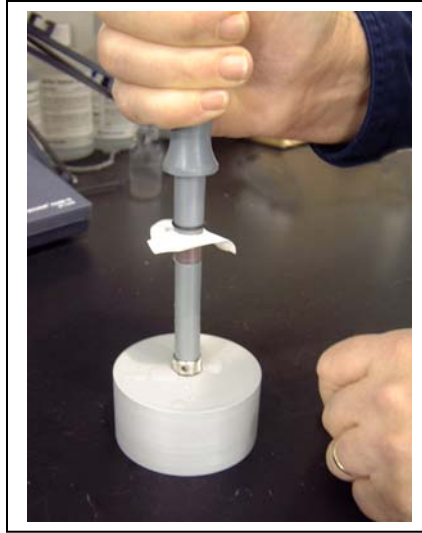

As shown in the picture below left, roll the o-ring off of the end of the installation tool so that it resides in the o-ring groove of the probe. Be sure to hold onto the O-ring prior to removing the installation tool so that it does not pop out of the groove. Then, as shown below right, remove the installation tool and make certain that the o-ring is centered in the groove on probe end.



As shown in the picture below, use a razor blade or knife to trim away the excess membrane material.



The pictures below show a properly installed free chlorine membrane. Note that, because the membrane will not stretch, there may be some points where the membrane is slightly “bunched up” in the o-ring groove. This effect is normal and will not affect sensor function. Also note that the presence of bubbles under the membrane is also normal and should not affect probe function

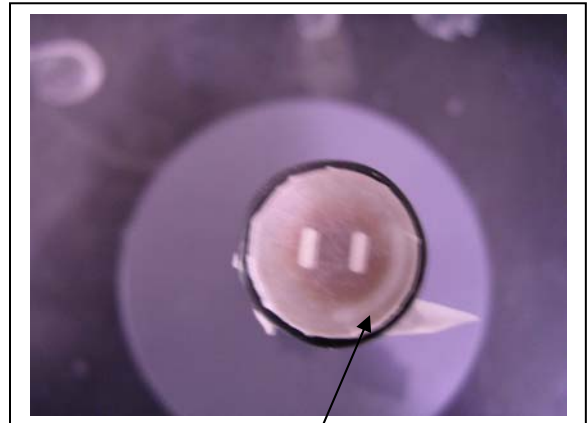

Note the presence of a bubble after installation. This is acceptable for a free chlorine membrane.

After installing the membrane, either proceed immediately to the sensor activation protocol described above in the Quick Start Guide or store the probe in a beaker of tap water (NOT deionized or distilled water) as shown in the picture below to prevent drying out. Be sure to place the probe GENTLY into the beaker to avoid damaging the membrane integrity.



NOTE CAREFULLY: Users who are accustomed to installing a Teflon membrane on a YSI dissolved oxygen sensor should note that the methods recommended for the Teflon installation are not likely to work well for the free chlorine membrane because this membrane cannot be stretched. Therefore, dissolved oxygen membrane installation techniques which are outline in the manuals for various YSI instruments, including standard 6-series sondes utilizing the 6562 Rapid Pulse DO sensor, are **NOT RECOMMENDED** for the free chlorine membrane installation.

2.3.2 STEP 2 - INSTALLING THE PROBES

Remove the calibration cup from your sonde by hand as shown below to expose the bulkhead.

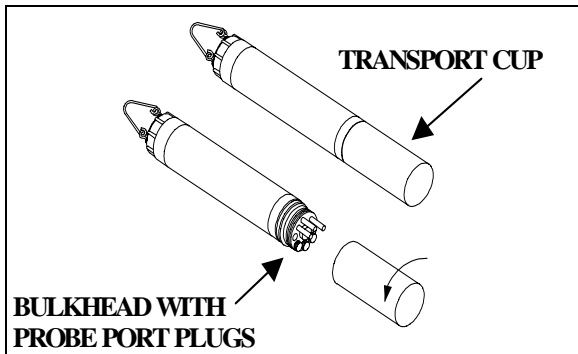

REMOVING THE PORT PLUGS

Using the long extended end of the probe installation tool supplied in the YSI 6570 Maintenance Kit, remove the port plugs. Save all the port plugs for possible future use.

There are a variety of probe options for the sondes. The figures below and to the right illustrate the uses of the common tool for port plug removal. Note that this tool will also be used to install the various probes.

If the tool is misplaced or lost, you may use 7/64" and 9/64" hex keys as substitutes.

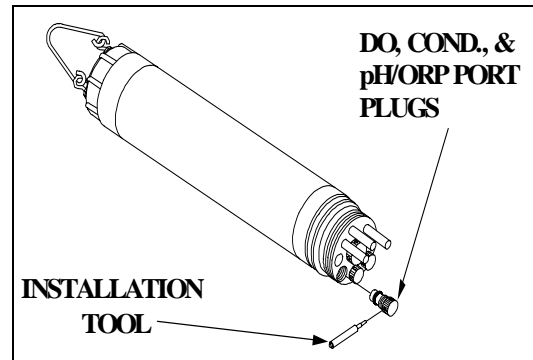
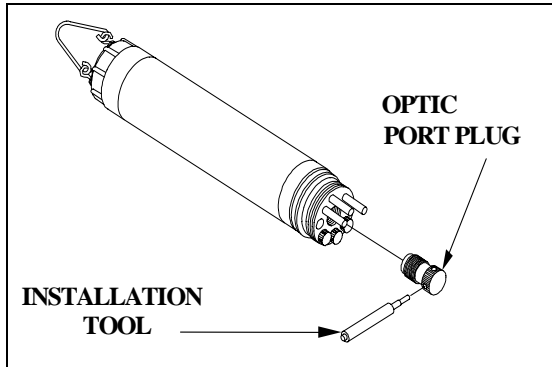
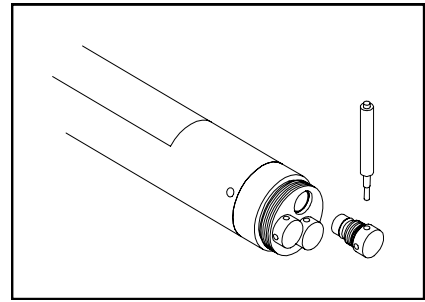

NOTE: You may need pliers to remove the ISE port plugs, but do not use pliers to tighten the ISE probes. Hand-tighten only.

Now refer to the figures below to find the probe locations in your sonde.

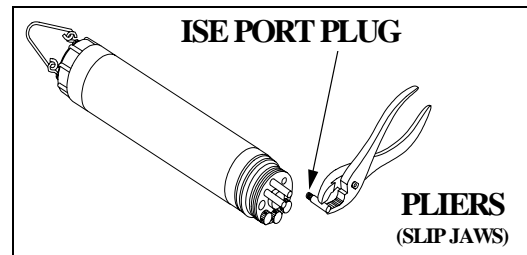

600DW-B SONDE BULKHEAD

- ❑ 6572 Free Chlorine = 3-pin connector
- ❑ 6560 Conductivity/Temperature = 6-pin connector
- ❑ 6561 pH = 4-pin connector
- ❑ 6565 Combo pH/ORP = 4-pin connector
- ❑ 6566 Fouling Resistant pH//ORP = 4 pin connector
- ❑ 6561FG pH (Flat Glass) = 4-pin connector
- ❑ 6565FG pH/ORP (Flat Glass) = 4-pin connector

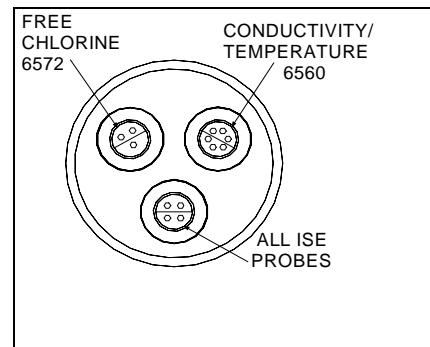

6920DW SONDE BULKHEAD

- ❑ 6572 Free chlorine probe = 3-pin connector
- ❑ 6560 Conductivity/Temperature = 6-pin connector
- ❑ 6561 pH = 4-pin connector
- ❑ 6565 Combo pH/ORP = 4-pin connector
- ❑ 6566 Fouling Resistant pH/ORP = 4 pin connector
- ❑ 6561FG pH (Flat Glass) = 4-pin connector
- ❑ 6565FG pH/ORP (Flat Glass) = 4-pin connector
- ❑ 6882 Chloride Probe = leaf spring connector
- ❑ 6883 Ammonium Probe = leaf spring connector
- ❑ 6884 Nitrate Probe = leaf spring connector
- ❑ 6026 Turbidity Probe, Wiping = 8 pin connector
- ❑ 6136 Turbidity Probe, Wiping = 8 pin connector
- ❑ 6025 Chlorophyll Probe, Wiping = 8 pin connector
- ❑ 6130 Rhodamine WT Probe, Wiping = 8 pin connector

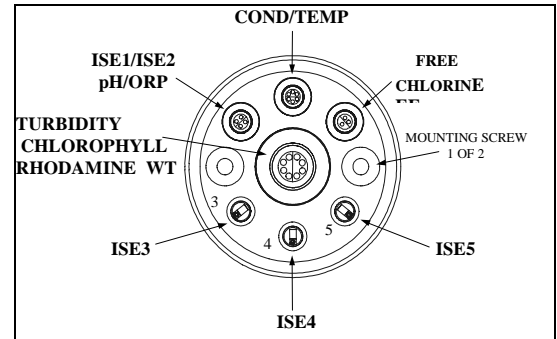

LUBRICATE O-RINGS

Apply a thin coat of O-ring lubricant, supplied in the YSI 6570 Maintenance Kit, to the O-rings on the connector side of each probe that is to be installed.

CAUTION: Make sure that there are **NO** contaminants between the O-ring and the probe. Contaminants that are present under the O-ring may cause the O-ring to leak when the sonde is deployed.

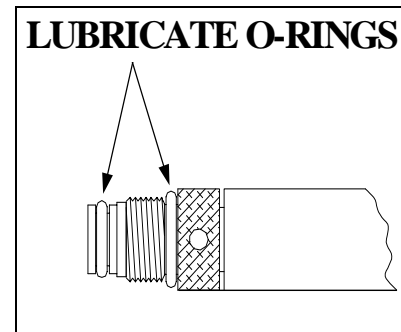

NOTE: Before installing any probe into the sonde bulkhead, be sure that the probe port is free of moisture. If there is moisture present, you may use compressed air to blow out the remaining moisture.

INSTALLING THE TURBIDITY, CHLOROPHYLL, AND RHODAMINE WT PROBES

If you have a turbidity, chlorophyll, and/or rhodamine WT probe, it is recommended that the optical sensors be installed first. If you are not installing one of these probes, do not remove the port plug, and go on to the next probe installation.

All optic probes, 6026 and 6136 turbidity, 6025 chlorophyll, and 6130 rhodamine WT are installed in the same way. Install the probe into the center port, seating the pins of the two connectors before you begin to tighten. Tighten the probe nut to the bulkhead using the short extended end of the tool supplied with the probe. Do not over-tighten.

CAUTION: Be careful not to cross-thread the probe nut.

Note that the YSI 6920DW sondes can accept only a single turbidity, chlorophyll, or rhodamine WT probe.

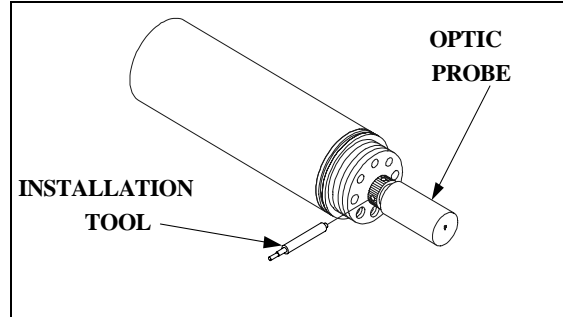

INSTALLING THE FREE CHLORINE PROBE, CONDUCTIVITY/TEMP AND pH/ORP PROBES

Insert the probe into the correct port and gently rotate the probe until the two connectors align.

The probes have slip nuts that require a small probe installation tool to tighten the probe. With the connectors aligned, screw down the probe nut using the long extended end of the probe installation tool. Do not over-tighten.

CAUTION: Do not cross thread the probe nut.

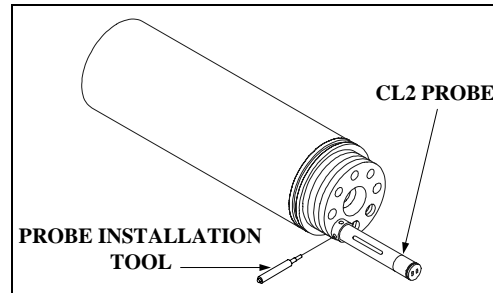

INSTALLING THE ISE PROBES

The Ammonium, Nitrate and Chloride ISE probes do not have slip nuts and should be installed without tools. Use only your fingers to tighten. Any ISE probe can be installed in any of the three ports labeled “3”, “4”, and “5” on the sonde bulkhead. Be sure to remember which sensor was installed in which port so that you will later be able to set up the sonde software correctly.

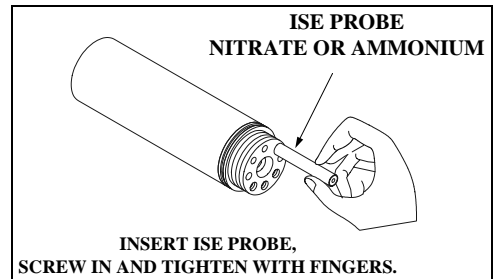

IMPORTANT: Make sure that the probe nut or probe body of the ISE probes are seated directly on the Sonde Bulkhead. This will ensure that connector seals will not allow leakage.

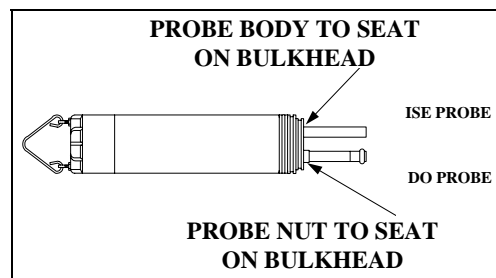

INSTALLING THE PROBE GUARD

Included with each sonde is a probe guard although customers will seldom use this item for drinking water studies. The probe guard protects the probes during some calibration procedures and should be used if the sonde were ever used in field studies that did not involve the flow cell. Once the probes are installed, install this guard by aligning it with the threads on the bulkhead and turn the guard clockwise until secure.

CAUTION: Be careful not to damage the free chlorine membrane during installation of the probe guard.

The figure below shows the YSI 6920DW probe guard; the guard for the 600DW-B is similar.

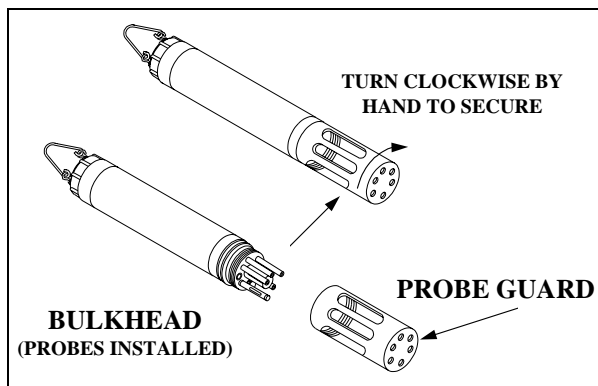

2.3.3 STEP 3 - POWER

The YSI 6920DW and 600DW-B sondes have internal batteries or can run on external power.

In addition, if you have purchased a YSI 650 MDS display/logger or 6500 Process Monitor, attaching your sonde to these instruments will allow your sonde to be powered from the batteries of the 650 or the AC power of the 6500.

POWER FOR LAB CALIBRATION

Using a YSI 6038 (110 VAC) or 6651 (100-240VAC) Power Supply to power the sondes in the lab is often convenient and extends battery life. In addition, AC power will likely be available for many drinking water studies and the 6651/6038 may be the most efficient method of providing power for long term monitoring studies. After attaching the four-pin connector from the power supply to the instrument cable (see below), simply plug the power supply into the appropriate AC outlet.

See **Section 2.2, Connecting Your Sonde**, for specific information on cables, adapters and power supplies required for connecting your sonde to various devices.

The system configuration best suited for initial setup is shown in the figure at the right.

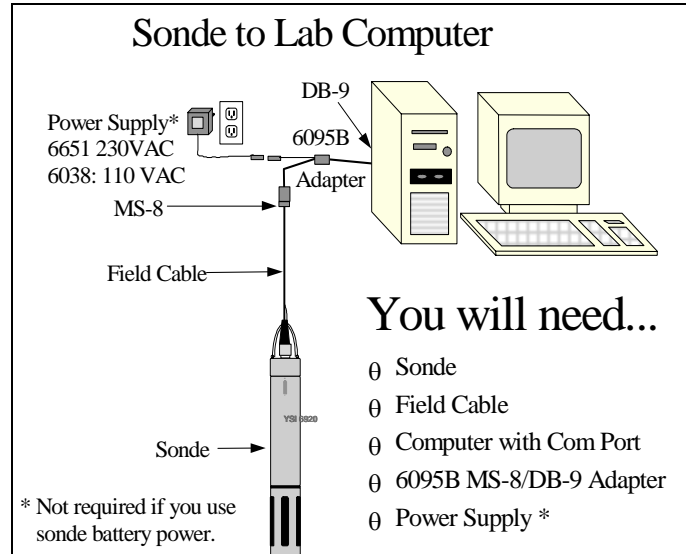

INSTALLING BATTERIES

The 6920DW and 600DW-B can also be powered by internal batteries and a set of batteries is supplied with each of these sondes. See the sections below for instructions for battery installation

INSTALLING BATTERIES INTO THE YSI 600DW-B

To install 4 AA-size alkaline batteries into the sonde, refer to the following directions and the figure below.

Grasp the cylindrical battery cover and unscrew by hand in a counterclockwise direction. Then slide the battery lid up and over the bulkhead connector. Insert batteries, paying special attention to polarity. Labeling on the battery compartment posts describes the orientation. It is usually easiest to insert the negative end of battery first and then “pop” the positive terminal into place.

Check the O-ring and sealing surfaces for any contaminants that could interfere with the O-ring seal of the battery chamber.

Lightly lubricate the o-ring on the outside of the battery cover. **DO NOT** lubricate the internal o-ring.

Return the battery lid and tighten by hand. **DO NOT OVER-TIGHTEN.**

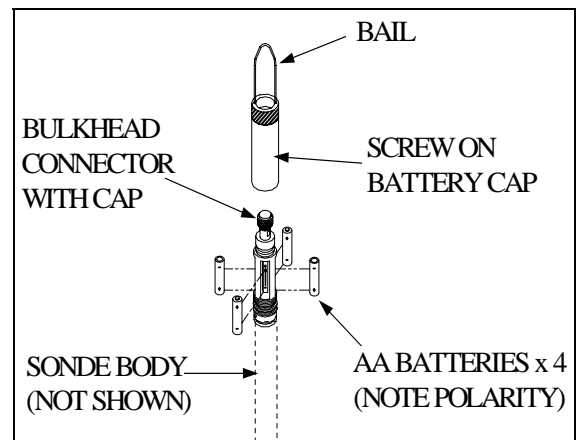

INSTALLING BATTERIES INTO THE 6920DW

To install the 8 AA-size alkaline batteries into the sonde, refer to the following directions and the adjacent figures.

Position the bail so that it is perpendicular to the sonde and use it as a lever to unscrew the battery cap by hand. Then slide the battery lid up and over the bulkhead connector.

Insert batteries, paying special attention to polarity. Labeling on the top of the sonde body describes the orientation.

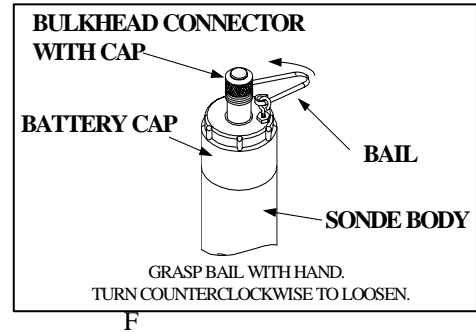

Check the O-rings and sealing surfaces for any contaminants that could interfere with the seal of the battery chamber.

Lightly lubricate the o-rings on the bottom of the threads and on the connector stem as shown in the figure at the right.

Return the battery lid and tighten by hand. *DO NOT OVERTIGHTEN.*

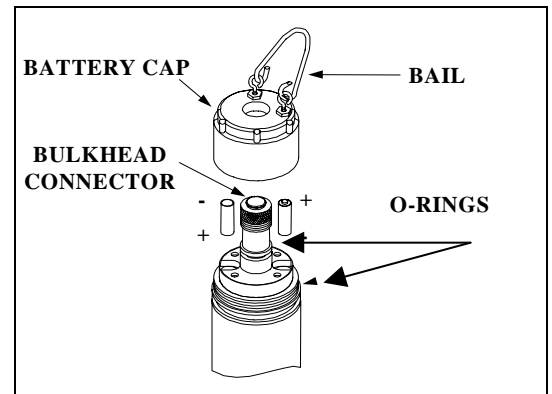

2.3.4 STEP 4 - CONNECTING A FIELD CABLE

As shown in the picture at left, the 6920DW and 600DW-B have a sonde-mounted cable connector for attachment of cables. Two types of cables are available – a “field cable” in various lengths up to 200 feet and a short 6067B laboratory calibration cable.

To attach a field cable to the sonde connector, remove the waterproof cap from the sonde connector and set it aside for later reassembly during deployment or storage. Then connect your field cable to the sonde connector.

A built-in “key” will ensure proper pin alignment. Rotate the cable gently until the “key” engages and then tighten the connectors together by rotating clockwise. Attach the strain relief connector to the sonde bail. Rotate the strain relief connector nut to close the connector’s opening.

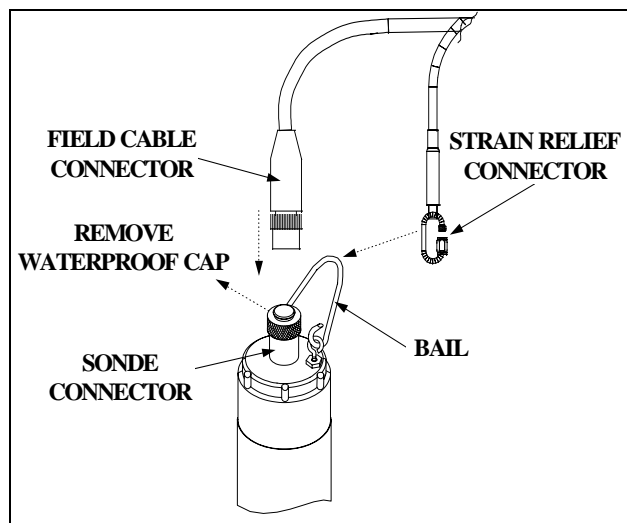

The other end of the field cable is a military-style 8-pin connector (MS-8). Through use of a YSI 6095B MS-8 to DB-9 adapter, the sonde may be connected to a computer for setup, calibration, real-time measurement, and uploading files.

This MS-8 connector also plugs directly into the 650 MDS display/logger or the 6500 Process Monitor. These instruments contain microprocessors with software which provides the ability to set up and calibrate your sonde sensors in a similar way to that of a terminal interface to a PC.

As an alternative to the field cable for interface to a PC, you may use a YSI 6067B calibration cable for laboratory interaction with the sonde. In this case, simply plug the proper end of the cable into the sonde connector and attach the DB-9 connector of the cable to the Com port of your computer. Note that the 6067B will not interface to a 650 Display/Logger or 6500 Process Monitor.

For drinking water studies involving only internal logging of data or real-time display of data on a PC using EcoWatch for Windows software, the 6067B may be the cable of choice.

2.4 ECOWATCH FOR WINDOWS -GETTING STARTED

This section will describe how to get started with EcoWatch for Windows, but detailed information is provided in **Section 4, EcoWatch for Windows**, or a convenient Windows Help section that is part of the software. It is recommended that you thoroughly read Section 4 or use the Help function for a comprehensive understanding of EcoWatch for Windows.

2.4.1 INSTALLING ECOWATCH FOR WINDOWS

EcoWatch for Windows software must be used with an IBM-compatible PC with a 386 (or better) processor. The computer should also have at least 4MB of RAM and Windows Version 3.1 or later.

Place the EcoWatch for Windows compact disk in your CD ROM drive. Select **Start**, then **Run** and type **d:\setup.exe** at the prompt. Press **Enter** or click on “**OK**” and the display will indicate that EcoWatch is proceeding with the setup routine. Simply follow the instructions on the screen as the installation proceeds.

2.4.2 RUNNING ECOWATCH FOR WINDOWS

To run EcoWatch for Windows, simply select the EcoWatch icon on your desktop or from the Windows Program Menu. For help with the EcoWatch program, see **Section 4, EcoWatch** or use the Help section of the software.

2.4.3 ECOWATCH FOR WINDOWS SETUP

To setup the EcoWatch software for use with a sonde, select the sonde icon  on the toolbar, and then the **proper** Com port (1 or 2) to which your sonde is connected. If the default setting is correct, it does not need to be changed. Click “**OK**” to open a terminal window.

From the **Comm** Menu, select the **Settings** option to check the baud rate. The baud rate should be 9600. If it is not, select 9600 from the list and press **Enter**.

From the **Settings** Menu, select the **Font/Color** and **Background Color** options to choose a color scheme for the EcoWatch for Windows menus.

2.5 SONDE SOFTWARE SETUP

There are two sets of software at work in any YSI environmental monitoring system. One is resident in the sonde and the other is associated with the interface device (a PC, 650 Display/Logger, or 6500 Process Monitor). If you are using a PC for your initial sonde setup as recommended, you will be using EcoWatch for Windows software which was installed as described above and you should follow the instructions in the section below to prepare your DW sonde for use. If you are using a 650 for sonde interface, see Section 5 for setup and interface instructions. If you are using a 6500 for sonde interface, see the manual which was supplied with this instrument.

For PC-based sonde interface, run EcoWatch for Windows and click on the sonde icon,  from the toolbar. Then select the proper Com port and confirm by clicking **OK**. A window similar to that shown below will appear indicating connection to the sonde as shown in the figure below. Type “**Menu**” after the # sign, press **Enter**, and the sonde Main menu will be displayed.

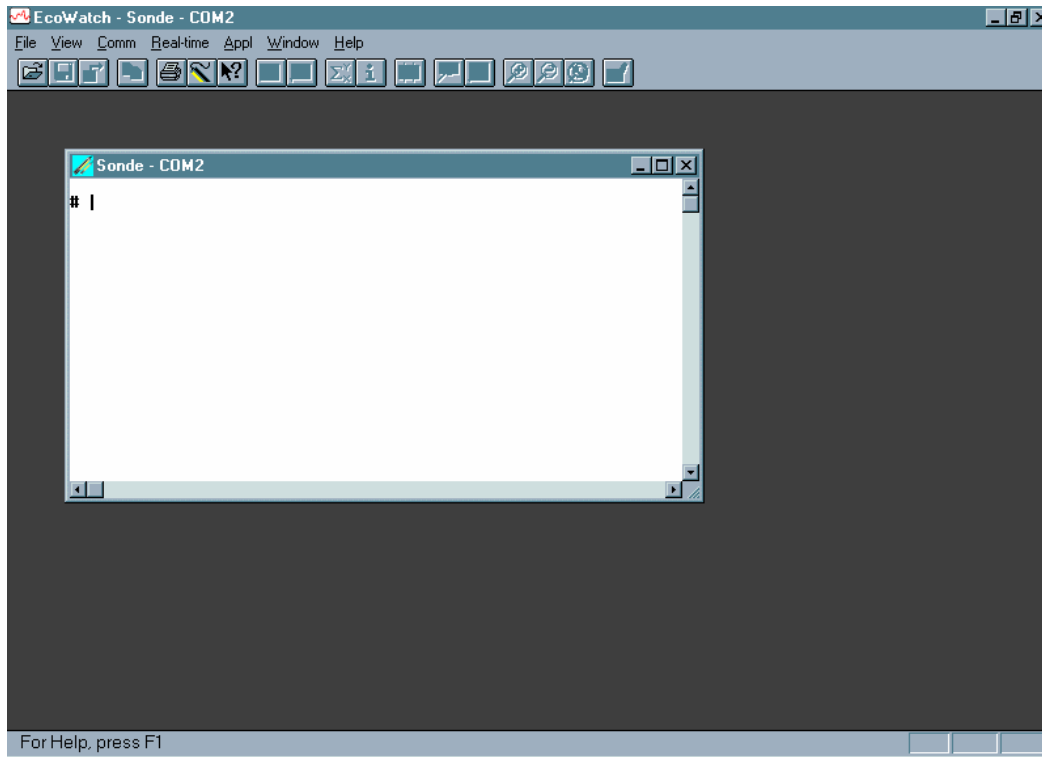

If your sonde has previously been used, the **Main menu** (rather than the # sign) may appear when communication is established. In this case simply proceed as described below. You will not be required to type “**Menu**”.

If you are unable to establish interaction with the sonde, make sure that the cable is properly connected. If you are using external power, make certain that the YSI 6038 or 6651 power supply or other 12 vdc source is properly working. Recheck the setup of the Com port and other software parameters. Also refer to **Section 6, Troubleshooting**.

The sonde software is menu-driven. You select functions by typing their corresponding numbers. You do not need to press **Enter** after choosing a selection. Type the **0** or **Esc** key to return to the previous menu.

Sonde Main Menu

```

-----Main-----
1-Run           5-System
2-Calibrate     6-Report
3-File         7-Sensor
4-Status       8-Advanced

Select option (0 for previous menu):
    
```

Sonde Menu Flow Chart

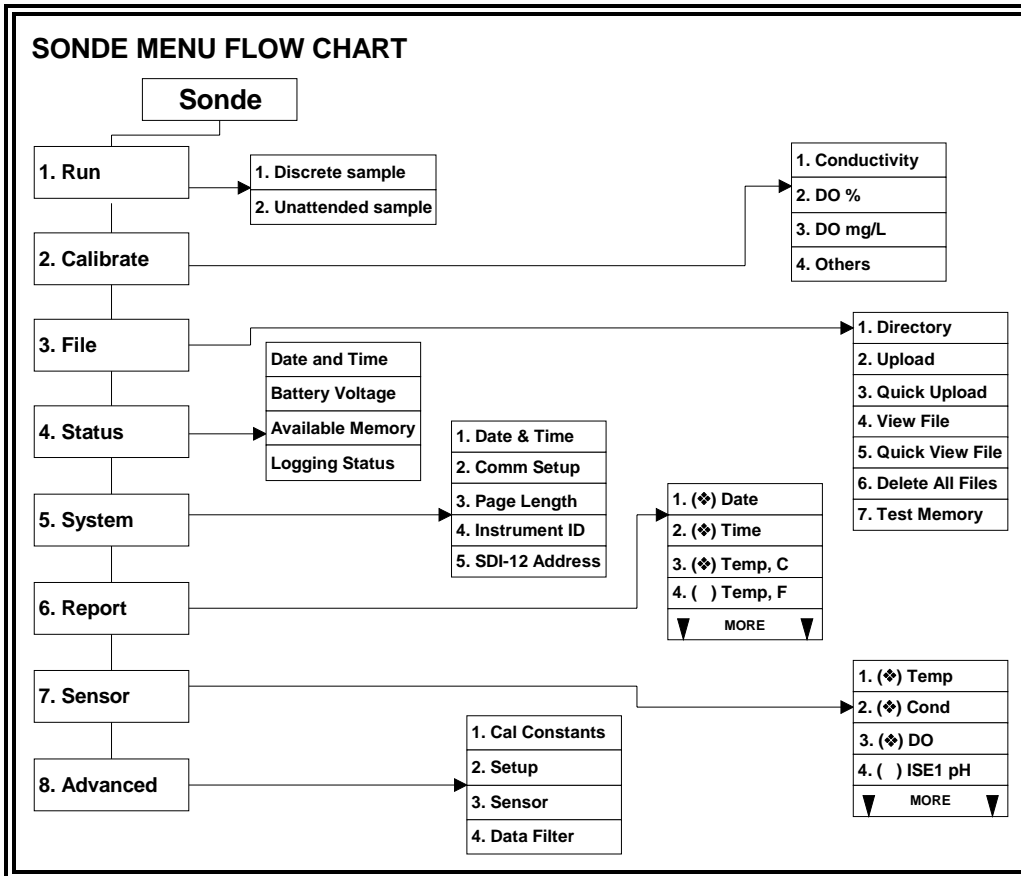

SYSTEM SETUP

At the Main menu, select **System**. The System Setup menu will be displayed.

System Setup Menu

```

1-Date & time
2-Comm setup
3-Page length=25
4-Instrument ID=YSI Sonde
5-Circuit board SN:00003001
6-GLP filename=00003001
7-SDI-12 address=0
8-(*)English
9-( )Fran?ais
A-( )Deutsch

Select option (0 for previous menu):

```

Select **1-Date & time**. An asterisk will appear next to each selection to confirm the entry. Press **4** and **5** to activate the date and time functions. Pay particular attention to the date format that you have chosen when entering date. You must use the 24-hour clock format for entering time. Option **4- () 4 digit year** may be used so that the date will appear with either a two or four digit year display. If you do not enter the correct year format (8/30/**98** for 2-digit, 8/30/**1998** for 4 digit) your entry will be rejected.

```

-----Date & time setup-----
1-(*)m/d/y           4-( )4 digit year
2-( )d/m/y           5-Date=08/11/98
3-( )y/m/d           6-Time=11:12:30

Select option (0 for previous menu):

```

Select **4-Instrument ID** from the System setup menu to record the instrument ID number (usually the instrument serial number), and press **Enter**. A prompt will appear which will allow you to type in the serial number of your sonde. This will make sure that any data that is collected is associated with a particular sonde. Note that the selection **5-Circuit Board SN** shows the serial number of the PCB that is resident in your sonde (not the entire system as for Instrument ID). Unlike the **Instrument ID**, the user cannot change the **Circuit Board SN**. The **6-GLP filename** and **7-SDI-12 address** selections will be explained in Section 2.9.5

Press **Esc** or **0** to return to the **System setup** menu.

At the bottom of the menu choose the language you prefer for the sonde software. For example, press **7- () English** to use the sonde with English menus.

```

1-Date & time
2-Comm setup
3-Page length=25
4-Instrument ID=YSI Sonde
5-Circuit board SN:00003001
6-GLP filename=00003001
7-SDI-12 address=0
8-(*)English
9-( )Fran?ais
A-( )Deutsch

Select option (0 for previous menu):

```

Then press **Esc** or **0** again to return to the **Main menu**.

```

-----Main-----
1-Run                5-System
2-Calibrate          6-Report
3-File               7-Sensor
4-Status             8-Advanced

Select option (0 for previous menu):

```

ENABLING SENSORS

To activate the sensors that are in your sonde, select **Sensor** from the Sonde Main menu.

```

-----Sensors enabled-----
1-(*)Time
2-(*)Temperature
3-(*)Conductivity
4-(*)Free Cl2
5-(*)ISE1 pH
6-(*)ISE2 Orp
7-(*)ISE3 NH4+
8-(*)ISE4 NO3-
9-( )ISE5 NONE
A-(*)Turbidity 6026

Select option (0 for previous menu):

```

Note that the exact appearance of this menu will vary depending upon the sensors that are available on your sonde. Enter the corresponding number to enable the sensors that are installed on your sonde. An asterisk indicates that the sensor is enabled.

When selecting any of the ISE or Optical ports, a submenu will appear. When this occurs, make a selection so that the sensor corresponds to the port in which the sensor is physically installed. Only ORP can be enabled as ISE2. Optic T and Optic C generate a submenu on selection. Each optical port can have one of four probes (6026 turbidity, 6136 turbidity, chlorophyll, or rhodamine WT) installed as indicated by the submenus.

After all installed sensors have been enabled, press **Esc or 0** to return to the Main Menu.

ENABLING PARAMETERS

In order for a specific parameter to be displayed:

1. The sensor must first be enabled as described above.
2. That parameter must be activated in the Report Setup menu described below.

Select **Report** from the Main menu. A Report Setup menu similar to the one shown below will be displayed.

```

-----Report setup-----
1-(*)Date m/d/y      D-(*)Orp mV
2-(*)Time hh:mm:ss  E-(*)NH4+ N mg/L
3-(*)Temp C         F-( )NH4+ N mV
4-(*)SpCond mS/cm   G-( )NH3 N mg/L
5-( )Cond           H-(*)NO3- N mg/L
6-( )Resist         I-( )NO3- N mV
7-( )TDS            J-(*)Cl- mg/L
8-( )Sal ppt        K-( )Cl- mV
9-(*)Cl2 mg/L       L-(*)Turbid NTU
A-(*)Cl2chrg
B-(*)pH
C-( )pH mv

Select option (0 for previous menu):

```

Note that the exact appearance of this menu will vary depending upon the sensors that are available and enabled on your sonde. The asterisks (*) that follow the numbers or letters indicate that the parameter will appear on all outputs and reports. To turn a parameter on or off, type the number or letter that corresponds to the parameter.

Note also that since a 6026 turbidity probe was selected in the Sensor menu above, the units of turbidity are presented as “turbid NTU”. If a 6136 turbidity probe had been selected, the units of turbidity would be presented as “turbid+ NTU”. This new designation is designed to differentiate the data from the two sensors types in later analysis.

For parameters with multiple unit options such as temperature, conductivity, specific conductance, resistivity and TDS, a submenu will appear as shown below for temperature, allowing selection of desired units for this parameter.

```
-----Select units-----
1-(*)NONE
2-( )Temp C
3-( )Temp F
4-( )Temp K

Select option (0 for previous menu): 2
```

After configuring your display with the desired parameters, press **Esc or 0** to return to the Main menu.

CHECKING ADVANCED SETTINGS

Select **Advanced** from the Main menu. The following menu will be displayed.

```
-----Advanced-----
1-Cal constants
2-Setup
3-Sensor
4-Data filter

Select option (0 for previous menu):
```

Select **Setup** from the Advanced menu.

```
-----Advanced setup-----
1-(*)VT100 emulation
2-( )Power up to Menu
3-( )Power up to Run
4-( )Comma radix
5-(*)Auto sleep RS232
6-(*)Auto sleep SDI12
7-( )Multi SDI12
8-( )Full SDI12

Select option (0 for previous menu): 0
```

Make sure that, other than **Auto sleep RS232**, all entries are activated or deactivated as shown above.

For sondes which will be used in sampling studies where the user is present and observes readings in real-time, **Auto sleep RS232** should usually be “off”. For sondes that will be used in unattended monitoring

studies, **Auto sleep RS232** should usually be “on”. This is described in detail in **Section 2.9, Sonde Menu**. When this setup is verified, press **Esc** or **0** to return to the Advanced menu.

Select **3-Sensor** from the Advanced menu and make certain that the entries are identical to those shown below.

```

-----Advanced sensor-----
1-TDS constant=0.65
2-Cl2 temp co %/C=2.5
3-Cl2 warm up sec=60
4-( )Wait for Cl2
5-Wipes=1
6-Wipe int=1
7-SDI12-M/wipe=1
8-Turb temp co %/C=0.3
9-(*)Turb spike filter
A-Chl temp co %/C=0
B-( )Chl spike filter

Select option (0 for previous menu):

```

The display under **3-Sensor** may be different from the one shown in the example above, depending on the sensors that are installed in your unit. For example, if you do not have a chlorophyll probe, the last two entries (which are relevant only to chlorophyll) will not appear.

When this setup is verified, press **Esc** or **0** to return to the Advanced menu. For a detailed explanation of the choices in the Advanced menu, see **Section 2.9.8, Advanced**. Press **Esc** or **0** to back up to the Main menu.

```

-----Main-----
1-Run           5-System
2-Calibrate    6-Report
3-File         7-Sensor
4-Status       8-Advanced

Select option (0 for previous menu):

```

The sonde software is now set up and ready to calibrate and run.

2.6 GETTING READY TO CALIBRATE

2.6.1 INTRODUCTION

HEALTH AND SAFETY

Reagents that are used to calibrate and check this instrument may be hazardous to your health. Take a moment to review health and safety information in Appendix A of this manual. Some calibration standard solutions may require special handling.

PREPARING THE 6572 FREE CHLORINE PROBE FOR CALIBRATION

Before calibration of the free chlorine sensor can be carried out, it needs to be “activated” according to the following instructions:

- Remove the 6572 free chlorine probe from the sonde bulkhead (if it has been installed previously). Make certain that a membrane has been installed correctly as documented in Section 2.3 above.
- Prepare a diluted solution of commercial chlorine bleach consisting of 1 part bleach to 200 parts purified water (distilled or deionized). For example, mix 1 mL of chlorine bleach with 200 mL of purified water.
- Place the free chlorine probe in the diluted bleach and leave for approximately 60 seconds. CAUTION: Do not leave the probe in bleach for longer than 1 minute or the break-in time for the probe will be excessive.
- Rinse the sensor tip and membrane with purified water and set aside in a beaker of tap (NOT deionized or distilled) water. **DO NOT REINSTALL THE PROBE IN THE SONDE BULKHEAD AT THIS TIME.**

Now follow the instructions below for calibration of the other sensors.

CONTAINERS NEEDED TO CALIBRATE A SONDE

The calibration cup that comes with your sonde serves as a calibration chamber for all calibrations except free chlorine and minimizes the volume of calibration reagents required. However, if you are using the 6026 or 6136 turbidity, the 6025 chlorophyll, or the 6130 rhodamine WT probes, you should visually verify proper movement of the wiper mechanism before beginning the calibration procedures.

Instead of the calibration cup, you may use laboratory glassware to perform many calibrations. If you do not use a calibration cup that is designed for the sonde, you are cautioned to do the following:

- ✓ Perform all calibrations with the Probe Guard installed. This protects the probes from possible physical damage.
- ✓ Use a ring stand and clamp to secure the sonde body to prevent the sonde from falling over. Much laboratory glassware has convex bottoms.

- ✓ Insure that all sensors are immersed in calibration solutions. Many of the calibrations factor in readings from other probes (e.g., temperature probe). The top vent hole of the conductivity sensor must also be immersed during calibrations.

CALIBRATION TIPS

1. The key to successful calibration is to insure that the sensors are completely submersed when calibration values are entered. Use recommended volumes when performing calibrations.
2. For maximum accuracy, use a small amount of previously used calibration solution to pre-rinse the sonde. You may wish to save old calibration standards for this purpose.
3. Fill a bucket with ambient temperature water to rinse the sonde between calibration solutions or perform the calibration near a sink where the probes can be rinsed from the tap.
4. Have several clean, absorbent paper towels or cotton cloths available to dry the sonde between rinses and calibration solutions. Shake the excess rinse water off of the sonde, especially when the probe guard is installed. Dry off the outside of the sonde and probe guard. Making sure that the sonde is dry reduces carry-over contamination of calibrator solutions and increases the accuracy of the calibration.
5. If you are using laboratory glassware for calibration, you do not need to remove the probe guard to rinse and dry the probes between calibration solutions. The inaccuracy resulting from simply rinsing the probe compartment and drying the outside of the sonde is minimal.
6. Make certain that port plugs are installed in all ports where probes are not installed. It is extremely important to keep these electrical connectors dry.

USING THE CALIBRATION CUP

Follow these instructions to use the calibration cup for calibration procedures with the 6920DW and 600DW-B sondes..

- ✓ Ensure that a gasket is installed in the gasket groove of the calibration cup bottom cap, and that the bottom cap is securely tightened. **Note:** Do not over-tighten as this could cause damage to the threaded portions of the bottom cap and tube.
- ✓ Remove the probe guard, if it is installed.
- ✓ Inspect the installed gasket on the sonde for obvious defects and if necessary, replace it with the extra gasket supplied.
- ✓ Screw cup assembly into place on the threaded end of sonde and securely tighten. **Note:** Do not over tighten as this could cause damage to the threaded portions of the bottom cap and tube.
- ✓ Sonde calibration can be accomplished with the sonde upright or upside down. A separate clamp and stand, such as a ring stand, is required to support the sonde in the inverted position.

NOTE CAREFULLY: When calibrating a turbidity sensor for use with the 6920DW, you can use either the standard calibration cup (with certain qualifications) or an optional extended length calibration cup. Please see the section below which describes the special calibration recommendations for this sensor.

RECOMMENDED VOLUMES OF CALIBRATION REAGENTS

The approximate volumes of the reagents are specified below for both the upright and upside down orientations.

Table 1 6920DW Sonde

Probe to Calibrate	Upright	Upside Down
Conductivity	200 mL	200 mL
pH/ORP	100 mL	250 mL
ISE	125 mL	275 mL
Turbidity, Chlorophyll, Rhodamine WT w/ Standard Calibration Cup*	40 mL	N/A
Turbidity, Chlorophyll, Rhodamine WT w/ Extended Calibration Cup*	220 mL	N/A

Table 2 600DW-B Sonde

Probe to Calibrate	Upright	Upside Down
Conductivity	50 mL	50 mL
pH/ORP	25 mL	50 mL

* See section below for special instructions dealing with calibration of the turbidity sensor with the two types of calibration cup.

CALIBRATION OF THE 6136 TURBIDITY SENSOR

When used with the 6920DW sonde, the 6136 can be calibrated using two types of vessels:

- The standard calibration cup which was supplied with the sonde and which minimizes the volume of calibration suspension required.
- An extended calibration cup which is designed to provide both the greatest accuracy and convenience, but which requires the use of higher volumes of calibration suspension.

If you choose to calibrate with the standard calibration cup, you should engage only ONE THREAD when screwing the calibration cup onto the sonde in order to keep the turbidity probe face as far as possible from the calibration cup bottom to avoid interference. Even with these techniques, there will still be a small interference from the bottom of the calibration cup that will cause your field turbidity readings to appear up to 1 NTU lower than the actual reading. In many cases, this small error is negligible in surface water studies, but can be important for drinking water studies where turbidity is generally very low. For example, a true turbidity of 0.5 NTU could appear as a value of -0.5 NTU for drinking water and this is a significant error.

The easiest way to avoid this error due to interference from the bottom of the calibration cup is to purchase an optional, extended-length calibration cup for your 6920DW sonde (YSI Item Number 655488). Use of these calibration cups completely eliminates bottom interference even when the calibration cup is completely threaded onto the sonde. The only drawback to the use of the extended length cup is that its use requires significantly higher volumes of calibration suspension. This factor is generally of no concern if you are

reusing the standard, but can be significant if the standard must be discarded after use according to your protocol.

For drinking water studies with the 6920DW and 600DW-B sondes where the turbidity is usually very low, YSI highly recommends the second method described above, i.e. the one utilizing the extended length calibration cups. If you wish to purchase these lengthened calibration cups, the parts to order are shown below and listed in the **Appendix C Accessories and Calibration Standards**:

Extended Calibration Cup Sleeve for the 6920DW – YSI Item # 655488

2.6.2 CALIBRATION PROCEDURES

CAUTION: Before beginning the calibration of any sensors, make certain that the 6572 free chlorine probe is REMOVED from the sonde bulkhead and stored in purified water. Then be sure to install a port plug in the vacated free chlorine port. Exposure of the free chlorine sensor to some of the reagents used to calibrate the other sensors can temporarily compromise the performance of the sensor.

The following calibration procedures are for the most commonly used sensors. For detailed information on all calibration procedures, refer to **Section 2.9.2, Calibrate**.

To ensure more accurate results, you can rinse the calibration cup with water, and then rinse with a small amount of the calibration solution for the sensor that you are going to calibrate. Discard the rinse solution and add fresh calibrator solution. Use tables 1-4 to find the correct amount of calibrator solution.

1. Carefully immerse the probes into the solution and rotate the calibration cup to engage several threads. YSI recommends supporting the sonde with a ring stand and clamp to prevent the sonde from falling over.
2. With the proper cable, connect the sonde to a PC, access EcoWatch for Windows and proceed to the Main menu (for information on how to run EcoWatch for Windows software, see **Section 2.4.2, Running EcoWatch Software**). From the sonde Main menu, select **2-Calibrate**.

```

-----Calibrate-----
1-Conductivity      6-ISE3 NH4+
2-Free Cl2          7-ISE4 NO3-
3-Pressure-Abs     8-Optic T-Turbidity-6026
4-ISE1 pH           9-Optic C-Chlorophyll
5-ISE2 ORP

Select option (0 for previous menu):

```

3. Note that the exact appearance of this menu will vary depending upon the sensors that are available and enabled on your sonde. To select any of the parameters from the Calibrate menu, input the number that is next to the parameter. Once you have chosen a parameter, some of the parameters will have a number that appears in parentheses. These are the default values and will

be used during calibration if you press **Enter** without inputting another value. Be sure not to accept default values unless you have assured that they are correct. If no default value appears, you must type a numerical value and press **Enter**.

4. After you input the calibration value, or accept the default, press **Enter**. A real-time display will appear on the screen. Carefully observe the stabilization of the readings of the parameter that is being calibrated. When the readings have been stable for approximately 30 seconds, press **Enter** to accept the calibration. The calibrated value is bolded on the example screen on the following page.
5. Press **Enter** to return to the Calibrate menu, and proceed to the next calibration.

CALIBRATION EXAMPLE

The example below for calibration of specific conductance, is designed to demonstrate the general calibration protocol for all parameters. From the Calibrate menu, press **1-Conductivity** and the following display will be shown.

```

-----Cond calibration-----
1-SpCond
2-Cond
3-Salinity

Select option (0 for previous menu): 1
  
```

Select **1-SpCond** (the generally-recommended method for calibration of a conductivity sensor), the following prompt will appear which calls for your numerical input.

```
Enter SpCond in mS/cm (10):
```

As noted above, the number in parentheses is the default value of this parameter and will be used in the calibration if *only* **Enter** is pressed without typing in another value. Similar prompts will be displayed during the calibration of all parameters, but for some sensors, such as pH, no default values are provided. In these cases, the user must input a numerical value and then press **Enter**.

After the calibration value is input and **Enter** is pressed, a real-time display similar to the following will then appear on the screen..

```

Date      Time      Temp SpCond  Sal    Cl2    Cl2 chrg  pH    Battery
mm/dd/yy hh:mm:ss  C  mS/cm  ppt    mg/L
-----
To calibrate, press <Enter> when the readings are stable.
05/05/97 08:39:51 20.83 9.602 8.837  1.04    8.5      7.06  10.2
  
```

Note that all parameters that have been enabled will appear - not just the one being calibrated at the moment. The user should carefully observe the stabilization of the readings of the parameter that is being calibrated

and, when the readings are stable for approximately 30 seconds, press **Enter** to implement the calibration and the following message will appear.

```
Calibrated. Press <Enter> to continue.
```

NOTE: If an ERROR message appears, begin the calibration procedure again. Be certain that the value you enter for the calibration standard is correct. Also see Section 8, Troubleshooting for more information on error messages.

CAUTION: Be certain to **immerse the entire sonde** in solution standards for calibration of all parameters. Most calibrations require readings not only from the sensor being calibrated but also from the temperature sensor.

Specific start-up calibration procedures for all sensors that commonly require calibration are provided in the following paragraphs of this section. Remember that these are basic protocols designed to get the user up and running with your 6-series sonde. A more-detailed discussion of sensor calibration can be found in Section 2.9.2.

CONDUCTIVITY

This procedure calibrates conductivity, specific conductance, salinity, and total dissolved solids.

Place the correct amount (see Tables 1-4) of 10 mS/cm conductivity standard (YSI 3163 is recommended) into a clean, dry or pre-rinsed calibration cup.

Before proceeding insure that the sensor is as dry as possible. Ideally, rinse the conductivity sensor with a small amount of standard that can be discarded. Be certain that you avoid cross-contamination of standard solutions with other solutions. Make certain that there are no salt deposits around the pH/ORP probe, particularly if you are employing standards of low conductivity.

Carefully immerse the probe end of the sonde into the solution. Gently rotate and/or move the sonde up and down to remove any bubbles from the conductivity cell. The probe must be completely immersed past its vent hole. Using the recommended volumes from the table in the previous subsection should insure that the vent hole is covered.

Allow at least one minute for temperature equilibration before proceeding.

From the Calibrate menu, select **Conductivity** to access the Conductivity calibration procedure and then **1-SpCond** to access the specific conductance calibration procedure. Enter the calibration value of the standard you are using (mS/cm at 25°C) and press **Enter**. The current values of all enabled sensors will appear on the screen and will change with time as they stabilize.

Observe the readings under Specific Conductance or Conductivity and when they show no significant change for approximately 30 seconds, press **Enter**. The screen will indicate that the calibration has been accepted and prompt you to press **Enter** again to return to the Calibrate menu.

Rinse the sonde in tap or purified water and dry the sonde.

NOTE: The YSI conductivity system is very linear over its entire 0-100 mS/cm range. Therefore, it is usually not necessary to use calibration solutions other than the 10 mS/cm reagent recommended above for all environmental applications from low conductivity freshwater to seawater. YSI does offer the 3161

(1 mS/cm) and 3165 (100 mS/cm) conductivity standards for users who want to assure maximum accuracy at the high and low ends of the sensor range. Users of the 1 mS/cm standard should be particularly careful to avoid contamination of the reagent. In fact, because of contamination issues, YSI does not recommend using standards less than 1 mS/cm. For example:

pH 2-POINT

Using the correct amount of pH 7 buffer standard (see Tables 1-4) in a clean, dry or pre-rinsed calibration cup, carefully immerse the probe end of the sonde into the solution. Allow at least 1 minute for temperature equilibration before proceeding.

From the Calibrate menu, select **ISE1 pH** to access the pH calibration choices and then press **2- 2-Point**. Press **Enter** and input the value of the buffer (7 in this case) at the prompt. Press **Enter** and the current values of all enabled sensors will appear on the screen and change with time as they stabilize in the solution. Observe the readings under pH and when they show no significant change for approximately 30 seconds, press **Enter**. The display will indicate that the calibration is accepted.

After the pH 7 calibration is complete, press **Enter** again, as instructed on the screen, to continue. Rinse the sonde in water and dry the sonde before proceeding to the next step.

Using the correct amount (see Tables 1-4) of an additional pH buffer standard into a clean, dry or pre-rinsed calibration cup, carefully immerse the probe end of the sonde into the solution. Allow at least 1 minute for temperature equilibration before proceeding.

Press **Enter** and input the value of the second buffer at the prompt. Press **Enter** and the current values of all enabled sensors will appear on the screen and will change with time as they stabilize in the solution. Observe the readings under pH and when they show no significant change for approximately 30 seconds, press **Enter**. After the second calibration point is complete, press **Enter** again, as instructed on the screen, to return to the Calibrate menu.

Rinse the sonde in water and dry. Thoroughly rinse and dry the calibration containers for future use.

NOTE: The majority of environmental water of all types has a pH between 7 and 10. Therefore, unless you anticipate a pH of less than 7 for your application, YSI recommends a two point calibration using pH 7 and pH 10 buffers.

The next calibration instructions are only for the 6920DW sonde. If you do not have this sonde, you may skip to 2.7, Taking Readings.

AMMONIUM (NH₄⁺), CHLORIDE (Cl⁻) and NITRATE (NO₃⁻) 3-POINT

WARNING: AMMONIUM AND NITRATE SENSORS CAN ONLY BE USED AT DEPTHS OF LESS THAN 50 FEET (15 METERS). USE OF THE SENSORS AT GREATER DEPTHS IS LIKELY TO PERMANENTLY DAMAGE THE SENSOR MEMBRANE.

The calibration procedures for ammonium, nitrate or chloride are similar to pH except for the reagents in the calibration solutions. Suggested values for calibrants are 1 and 100 mg/L of either ammonium-nitrogen (NH₄-N) or nitrate-nitrogen (NO₃-N). Suggested values for calibrants are 10 and 1000 mg/L of Chloride (Cl⁻).

NOTE: The following procedure requires one portion of the high concentration calibrant and two portions of the low concentration calibrant. The high concentration solution and one of the low concentration

solutions should be at ambient temperature. The other low concentration solution should be chilled to less than 10°C prior to beginning the procedure.

Place the proper amount of 100 mg/L standard (1000mg/l for chloride) into a clean, dry or pre-rinsed transport cup. Carefully immerse the probe end of the sonde into the solution. Allow at least 1 minute for temperature equilibration before proceeding.

Select **Ammonium, Nitrate, or Chloride** to access the appropriate calibration choices. Then select **3-3-Point**. Press **Enter** and input the concentration value of the standard as requested. Press **Enter** and the current values of all enabled sensors will appear on the screen and will change with time as they stabilize in the solution. Observe the readings under NH_4^+ , NO_3^- , or Cl^- . When they show no significant change for approximately 30 seconds, press **Enter**.

After the first calibration point is complete, proceed as instructed on the screen, to continue. Rinse the sonde in water and dry the sonde prior to the next step.

Place the proper amount of 1 mg/L standard for Ammonium or Nitrate (10 mg/l for Chloride) into a clean, dry or pre-rinsed transport cup. Carefully immerse the probe end of the sonde into the solution. Allow at least 1 minute for temperature equilibration before proceeding.

Press **Enter** and input the concentration value of the standard as requested.

Press **Enter** and the current values of all enabled sensors will appear on the screen and will change with time as they stabilize in the solution. Observe the readings under NH_4^+ , NO_3^- , or Cl^- and when they have show no significant change for approximately 30 seconds, press **Enter**.

After the second value calibration is complete, press **Enter** to continue. Place the proper amount of chilled 1 mg/L standard (10 mg/L for the chloride) into a clean, dry or pre-rinsed calibration cup. Carefully immerse the probe end of the sonde into the solution. Allow at least 5 minutes for temperature equilibration before proceeding.

Press **Enter** and input the concentration value of the standard as requested.

Press **Enter** and the current values of all enabled sensors will appear on the screen and will change with time as they stabilize in the solution. Observe the readings under NH_4^+ , NO_3^- or Cl^- and when they show no significant change for approximately 30 seconds, press **Enter**.

After the third value calibration is complete, press **Enter** to return to the Calibrate menu.

Thoroughly rinse and dry the calibration cups for future use.

CALIBRATION TIP: HOW TO AVOID DRIFT DURING CALIBRATION OF THE NH_4^+ , NO_3^- AND Cl^- PROBES AFTER pH CALIBRATION. Exposure to the high ionic content of pH buffers can cause a significant, but temporary, drift in these ISE probes (ammonium, nitrate and chloride probes). Therefore, when calibrating the pH probe, YSI recommends that you use one of the following methods to minimize errors in the subsequent readings:

- Calibrate pH first, immersing all of the probes in the pH buffers. After calibrating pH, place the probes in 100 mg/L nitrate or ammonium standard or 1000 mg/L chloride standard and monitor the reading. Usually, the reading starts low and may take as long as 30 minutes to reach a stable value. When it does, proceed with the calibration.
- When calibrating pH, remove ISE modules from the sonde bulkhead and plug the ports. After pH calibration is complete, replace the ISE sensors and proceed with their calibration with no stabilization delay.

TURBIDITY 2-POINT

Select **Optic T (or Optic C) –Turbidity-6136** from the Calibrate Menu and then **2-2-Point**.

NOTE: Before calibrating your 6136 turbidity sensor, pay particular attention to the following cautions:

- To properly calibrate YSI turbidity sensors, you **MUST** use standards that have been prepared according to details in *Standard Methods for the Treatment of Water and Wastewater (Section 2130 B)*. Acceptable standards include (a) formazin prepared according to *Standard Methods*; (b) dilutions of 4000 NTU formazin concentrate purchased from Hach; (c) Hach StablCal™ standards in various NTU denominations; and (d) AMCO-AEPA standards prepared specifically for the 6026 and 6136 by either YSI or approved vendors who are listed on the YSI website (www.ysi.com). **STANDARDS FROM OTHER VENDORS ARE NOT APPROVED FOR THE YSI TURBIDITY SYSTEM AND THEIR USE WILL LIKELY RESULT IN BOTH CALIBRATION ERRORS AND INCORRECT FIELD READINGS.**
- For AMCO-AEPA standards, the value entered by the user during the calibration protocol is DIFFERENT depending on which sensor (6026 or 6136) is being calibrated. This reflects the empirically determined fact that 6026 and 6136 sensors that have been calibrated to the same value in the primary standard formazin, will have different responses in suspensions of the AEPA-AMCO beads. This effect is likely due to the larger optical cell volume of the 6136. Thus, for example, the label of the YSI 6073 turbidity standard bottle indicates that the value of the standard is **100 NTU when used for calibration of the 6026 sensor, but 123 NTU when used to calibrate the 6136.** Note that the phenomenon of a sensor-specific formazin/AEPA-AMCO ratio is well known for sensors other than the 6026 and 6136.
- When calibrating a 6136 turbidity sensor you **MUST** use either a modified calibration cup arrangement, an extended length calibration cup or laboratory glassware with the probe guard installed for the calibration. See section 2.6.1 above for details. Failure to carry out the calibration properly can result in inaccurate readings, particularly water of very low turbidity.
- Before proceeding with the calibration, be certain that the probe compartment of the sonde has been cleaned and is free of debris. Solid particles from this source, particularly those carried over from past deployments, will contaminate the standards during your calibration protocol and cause either calibration errors and/or inaccurate field data.
 - One standard must be 0 NTU, and this standard must be calibrated first.

To begin the calibration, place the correct amount (see Tables 1-5) of 0 NTU standard (clear deionized or distilled water) into the calibration cup provided with your sonde. Immerse the sonde in the water. Input the value 0 NTU at the prompt, and press **Enter**. The screen will display real-time readings that will allow you to determine when the readings have stabilized. Activate the wiper 1-2 times by pressing **3-Clean Optics** as shown on the screen, to remove any bubbles. After stabilization is complete, press **Enter** to “confirm” the first calibration and then, as instructed, press **Enter** to continue.

Dry the sonde carefully and then place the sonde in the second turbidity standard (100 NTU is suggested) using the same container as for the 0 NTU standard. Input the correct turbidity value in NTU, press **Enter**, and view the stabilization of the values on the screen in real-time. As above, activate the wiper with the “3” key or manually rotate the sonde to remove bubbles. After the readings have stabilized, press **Enter** to confirm the calibration and then press **Enter** to return to the Calibrate menu.

NOTE CAREFULLY: If you are calibrating a 6136 turbidity sensor you **MUST** use either a modified calibration cup arrangement or laboratory glassware with the probe guard installed for the calibration. See

section 2.6.1 above for details. Failure to carry out the calibration properly can result in inaccurate readings, particularly in water of very low turbidity.

Thoroughly rinse and dry the calibration cups for future use.

CHLOROPHYLL 1-POINT

Select **Optic C -Chlorophyll** from the Calibrate Menu, **Chl µg/L** and then **1-1 point**.

NOTE: This procedure will zero your fluorescence sensor and use the default sensitivity for calculation of chlorophyll concentration in µg/L, allowing quick and easy fluorescence measurements that are only semi-quantitative with regard to chlorophyll. However, the readings will reflect changes in chlorophyll from site to site, or over time at a single site.

To increase the accuracy of your chlorophyll measurements, follow the 2-point or 3-point calibration protocols outlined in **Section 2.9, Sonde Menu**.

Before making any field readings, carefully read Section 5.12, about chlorophyll that describes practical aspects of fluorescence measurements.

To begin the calibration, place the correct amount of clear deionized or distilled water, from Tables 1, 2 and 3, into the YSI clear calibration cup provided. Immerse the sonde in the water. Input the value 0 µg/L at the prompt, and press **Enter**. The screen will display real-time readings that will allow you to determine when the readings have stabilized. Activate the wiper 1-2 times by pressing **3-Clean Optics** as shown on the screen to remove any bubbles from the sensor. After stabilization is complete, press **Enter** to “confirm” the calibration and then, as instructed, press **Enter** to return to the Calibrate menu.

Thoroughly rinse and dry the calibration cups for future use. For additional information related to calibrating the chlorophyll sensor, see Sections 5.12.

RHODAMINE WT 2-POINT

Select **Rhodamine** from the Calibrate Menu and then **2-2-Point**.

NOTE: One standard must be 0 ug/L in rhodamine WT, and this standard must be calibrated first.

To begin the calibration, place the correct amount (see Tables 1-4) of 0 standard (clear deionized or distilled water) into the calibration cup provided with your sonde and immerse the sonde in the water. Input the value 0 ug/L at the prompt, and press **Enter**. The screen will display real-time readings that will allow you to determine when the readings have stabilized. Activate the wiper 1-2 times by pressing **3-Clean Optics** as shown on the screen, to remove any bubbles. After stabilization is complete, press **Enter** to “confirm” the first calibration and then, as instructed, press **Enter** to continue.

Dry the sonde carefully and then place the sonde in the second rhodamine WT standard (100 ug/L is recommended) using the same container as for the 0 ug/L standard. Input the correct rhodamine WT concentration in ug/L, press **Enter**, and view the stabilization of the values on the screen in real-time. As above, activate the wiper with the “3” key or manually rotate the sonde to remove bubbles. After the readings have stabilized, press **Enter** to confirm the calibration and then press **Enter** to return to the Calibrate menu.

Thoroughly rinse and dry the calibration cups for future use.

FREE CHLORINE 1-POINT

The 6572 free chlorine sensor **MUST** be calibrated *in situ*, i.e. in flowing drinking water whose free chlorine content has been determined by an independent method. In many cases, the independent method involves the use of the DPD Colorimetric Method as defined in Section 4500-Cl G of *Standard Methods for the Examination of Water and Wastewater*. Relatively inexpensive colorimeters, such as the YSI Models 9000 and 9100 and the Hach Model 5870000, are available for carrying out the DPD method to determine the free chlorine in the effluent of the flow cell associated with the 6920DW or 600DW-B drinking water studies.

After activation of the sensor according to the instruction in Section 2.6.1 above and **AFTER** the calibration of all other sensors present, reinstall the free chlorine probe in the sonde bulkhead after removing the port plug. Make certain that no moisture is present in the port before installing the probe and, if moisture is present from the previous calibration procedures, use compressed air to dry the port.

After installing the free chlorine sensor in the sonde bulkhead, locate the flow cell which you purchased with your drinking water sonde and install the sonde in the flow cell according to the instruction supplied with the flow cell and as provided below:

- Attach inlet and outlet hoses to the barbed fittings supplied with the flow cell and then insert the fittings into the proper ports of the flow cell. Make certain that the hoses are attached very snugly to the barb fittings to prevent any possibility of catastrophic leakage. If necessary, standard hose clamps can be used to secure the hoses to the barbed fittings.
- Connect the inlet line of the flow cell to a drinking water tap and run the outlet line to a drain. Make certain that the inlet line is securely attached to the tap and that the outline line will not pop out of the drain under flow conditions.

NOTE CAREFULLY: Make certain that the inlet line is attached to the bottom fitting of the flow cell and the drain line is attached to the top fitting.

- Turn on the water with a flow rate of 500-1000 mL/minute (500 mL/min minimum).
- Break in the sensor by running it continuously in flowing tap water by one of the following methods:
 - If using a PC with EcoWatch for sonde interface, start a Discrete Sample study at a 4 second interval as described below and continue the study for 2-3 hours while displaying the readings on the PC monitor.
 - If using a 650 Display/Logger for sonde interface, choose the Sonde Run selection from the Main menu and continue the study for 2-3 hours while displaying the readings on the 650 screen.
 - If using a 6500 Process Monitor for sonde interface, simply allow the system to run for 2-3 hours while displaying the readings on the 6500 screen.

During the 2-3 hour break-in period, the Free Chlorine and Chlorine Charge readings should drop significantly and show reasonable stability for periods of 5 minutes.

NOTE: At the end of the break-in period, the Cl₂ Charge value should have a value between zero (0) and 35. If the Cl₂ charge value is greater than 35, a new membrane should be installed and the activation and break-in process should be repeated.

The free chlorine system should be calibrated using the same basic methods employed for other sonde sensors. The important thing to remember is to calibrate your sensor versus a flow cell effluent in the mode which you will be using to measure free chlorine. There are four basic modes of operation as described below with their corresponding calibration instructions:

1. **Stand-alone applications where data is being logged only to the internal memory of the sonde at a user selected interval.** For this mode of operation, make certain that the Autosleep RS232 feature is activated in the **Advanced|Setup** menu and that the Chlorine warm-up time is set to 60 seconds in the **Advanced|Sensor** menu. With these software entries in place, the user will input the free chlorine value from the DPD analysis of the flow cell effluent, and the unit will automatically calibrate after the selected warm up time. This method is described in greater detail below.
2. **Applications where the sonde is attached to a YSI 6500 Process Monitor utilizing the Sample and Hold feature of the sonde software.** For this mode of operation, first activate the **Sample and Hold** feature from the **Setup sonde** menu of the 6500 (Press the **Esc** and **Enter** keys of the 6500 front panel simultaneously to access this menu). Then select the desired interval for data to be sent to the 6500. Exit to the main display mode of the 6500 by pressing the **Esc** key repetitively and then press the **Cal** key on the 6500 front panel. Highlight the free chlorine sensor entry, enter the value from the DPD analysis of the effluent and press **Enter**. Then press **Enter** again to confirm the calibration. See Section 4 of the 6500 manual for detailed calibration instructions.
3. **Applications where the sonde is attached to a YSI 6500 Process Monitor and is outputting data continuously to the 6500.** For this mode of operation, access the **Sonde setup** menu of the 6500 as described above and make certain that the Sample and Hold feature is INACTIVE. Then exit to the main display mode of the 6500 by pressing the **Esc** key repetitively and press the **Cal** key on the 6500 front panel. Highlight the free chlorine sensor entry, enter the value from the DPD analysis of the effluent and press **Enter**. Observe the free chlorine readings in real-time and, when stable, press the **Enter** key to confirm the calibration. See Section 4 of the 6500 manual for detailed calibration instructions. Note that this mode of operation is NOT RECOMMENDED by YSI due to sensor maintenance issues which are explained in detail in Appendix G of this manual.
4. **Applications where the sonde is attached to a PC and data is being displayed to the computer monitor using the Real-Time mode of EcoWatch for Windows.** For this mode of operation, your must calibrate the free chlorine sensor before activating the Real-Time EcoWatch mode or after activating the Real-time feature of EcoWatch. Access the sonde menu after connection of the sonde to a PC or 650 Display logger and make certain that the Autosleep RS232 feature is activated in the **Advanced|Setup** menu and that the Chlorine warm-up time is set to 60 seconds in the **Advanced|Sensor** menu. With these software entries in place, the user will input the free chlorine value from the DPD analysis of the flow cell effluent, and the unit will automatically calibrate after the selected warm up time. Following calibration, attach the sonde to the PC and click on the Real-Time entry in the top toolbar (Do NOT click on the sonde icon in the lower toolbar). The Real-Time study will start automatically with data displayed graphically on the PC monitor and logged to the hard drive of the PC under the file name which you have selected. See Section 4.3.5 of this manual for detailed instruction in using the EcoWatch Real-Time mode.

Details of the calibration for the simple **Unattended sample** mode of operation (#1 above) are provided below. The initial instructions involving the setup of the flow cell/sonde system are also valid for calibration in the other modes of operation.

For the **Unattended sample** mode, the free chlorine sensor should be calibrated AFTER a logging study has been underway for 2-3 hours to assure the stabilization of the free chlorine sensor in the flowing tap water. The setup of the logging study (or Unattended Sampling) is described in detail in **Section 2.7 UNATTENDED SAMPLING** and **2.9.1 Run UNATTENDED SAMPLING**. To view the logged data to assure stability prior to calibration, see **Section 2.9.3 File**.

To calibrate the free chlorine sensor, carry out the following steps:

- Make certain that the flow of water through the flow cell is 500-1000 mL per minute (minimum 500 mL/min) and that the flow is set to the rate at which you will carry out your monitoring study.
- Interface to the sonde using a 650 display/logger, a PC running EcoWatch for Windows, or a 6500 Process Monitor. If you are using a PC or the 650 Display/Logger, select **8-Advanced** and then **2-Setup** and make certain that **Autosleep RS232** is active as shown in the box below.

```

-----Advanced setup-----
1-(*)VT100 emulation
2-( )Power up to Menu
3-( )Power up to Run
4-( )Comma radix
5-(*)Auto sleep RS232
6-(*)Auto sleep SDI12
7-( )Multi SDI12
8-( )Full SDI12

Select option (0 for previous menu): 0

```

- Set up your Unattended Sampling study as described above and allow readings to be logged to internal memory for 2-3 hours. Using the **File|View** command as described in Section 2.9.3, inspect the free chlorine readings and after they are stable proceed with the calibration as described below. If you are using a 6500 Process Monitor, observe the real-time readings on the display for 2-3 hours and make certain they are stable before proceeding with the calibration.
- Collect a sample of water from the outlet hose of the flow cell and immediately analyze it for free chlorine using an independent method, e.g., the DPD method with a YSI 9100 Photometer.
- If using a PC or 650 Display/Logger for sonde interface, return to the Main menu using the **Esc** key and select **2-Calibrate** and then **4-Free Cl2**.
- NOTE: If using a 6500 Process Monitor for the sonde interface, perform the calibration according to the instructions in Section 4 of the 6500 manual.
- At the prompt, input the independently determined free chlorine value and press **Enter**. A display similar to that shown below will appear on either the computer monitor or the 650 display. The calibration will occur automatically after the countdown on the screen reaches zero.

```

=====
Temp SpCond Sal DOsat Cl2 Depth pH NH4+ N NO3- N Turbid
C mS/cm ppt % mg/L feet mg/L mg/L NTU
-----
Stabilizing: 38

```

- After the warm-up time is complete, the readings just before and just after calibration are displayed. When you press **Enter**, the screen returns to the Free Chlorine Calibration menu.

2.7 TAKING READINGS

After you have (1) enabled the sensors, (2) set the report to show the parameters that you want to see, and (3) calibrated the sensors, you are now ready to take readings.

There are two basic approaches to sampling, Discrete and Unattended. Using discrete sampling, the sonde is connected via a communication cable to a PC or terminal. The sampling frequency is likely to be rapid (seconds) in order to obtain a representative sampling as you move from site to site. Readings will probably be logged to several different files.

Unattended sampling is normally done with sondes that have internal batteries as do the 600DW-B and the 6920DW. The sampling frequency is likely to be longer (minutes). A sonde is typically deployed for days or weeks at a time, and readings will be logged to a single file. The communication cable may be disconnected and internal battery power used to operate the sonde. Alternatively, the sonde may connect via SDI-12 communication to a data collection platform (DCP). Sondes without batteries need to be connected to an external power source for unattended sampling.

NOTE: The 600DW-B and 6920DW are designed around the long-term, continuous monitoring of drinking water if flow cell applications. Thus, for most studies data will either be stored at relatively long sample intervals (5-60 minutes) to the internal memory of the sonde using the Unattended mode or the sonde will be attached to a 6500 Process Monitor and the data will be output in 4-20 mA or Modbus format and stored in a SCADA system or similar external logger. Thus, while the Discrete sample mode may be required in some set-up and troubleshooting operations, most studies will be done using the Unattended mode.

Select **1-Run** from the Main menu to begin taking readings or to set/verify the parameters required for a study. There are two options in the Run menu as shown below.

```

-----Run setup-----
1-Discrete sample    2-Unattended sample
Select option (0 for previous menu): 1

```

DISCRETE SAMPLING

NOTE THAT THIS FUNCTION WILL NORMALLY BE USED IN DRINKING WATER STUDIES **ONLY** DURING THE BREAK-IN OF THE SENSOR AFTER RECONDITIONING.

Select **1-Discrete sample** from the Run menu. The Discrete sample menu will be displayed.

```

-----Discrete sample-----
1-Start sampling
2-Sample interval=4
3-File=
4-Site=
5-Open file

Select option (0 for previous menu):

```

Select **2-Sample Interval** to type a number that represents the number of seconds between samples. The maximum sample interval is 32767 seconds (9+ hours). The factory default sample interval is 4 seconds and works best for most discrete sampling applications. See section 2.9.1 for more details.

Select **3-File** to enter a filename with a maximum of 8 characters. This is the file to which you will log readings.

If you started sampling without entering a filename, the default name NONAME1 will be assigned to your file. Whenever you press 1-LOG last sample or 2-LOG ON/OFF from the menu, NONAME1 will be opened during sampling. If this happens, and you want to restart the file with a different name, press **5-Close file** and rename the file.

Select **4-Site** to assign a site name with a maximum of 31 characters. This allows you to enter the name of the site where you are sampling.

When you select **5-Open File**, a file is opened and the number 5 changes to **Close File**. When you are finished logging data to the file, press **5-Close File** and number 5 changes back to **Open File**.

Now select **1-Start sampling** to start discrete sampling.

After the initial sampling time interval has passed, (e.g. 4 seconds in the example above), sequential lines of data (similar to that shown below) will appear on the screen.

```

=====
Temp      Sal    DO%    pH     Depth  pH     NH4+ N NO3- N Turbid
  C      ppt    %SAT   feet          mg/L   mg/L   NTU
-----
*** 1-LOG last sample    2-LOG ON/OFF, 3-Clean optics ***
23.54  0.00  96.5   8.20   1.001  5.20  0.853  0.522  0.3
*** LOG is ON, hit 2 to turn it OFF, 3-Clean optics ***
23.53  0.00  96.5   8.20   1.001  5.20  0.856  0.520  0.3
23.53  0.00  96.5   8.20   1.000  5.20  0.854  0.521  0.3
23.53  0.00  96.5   8.20   1.000  5.19  0.852  0.522  0.3
*** 1-LOG last sample    2-LOG ON/OFF, 3-Clean optics ***
23.53  0.00  96.5   8.20   1.000  5.19  0.852  0.522  0.3
Sample logged.

```

The following prompt will appear just below the screen header:

1-LOG last sample, 2-LOG ON/OFF, 3-Clean optics.

By entering **1-LOG last sample**, a single line of data can be logged to sonde memory and the following message will be displayed: **Sample logged.**

By entering **2-LOG ON/OFF**, a set of data can be logged to memory and the following message will be displayed: **LOG is ON, hit 2 to turn it OFF, 3-Clean optics.** Press **2** again to terminate logging.

By entering **3-Clean optics**, if your unit has an optical (turbidity, chlorophyll, or rhodamine WT) probe, the wiper will clean the optical surface. The **3-Clean optics** portion of the prompt will only appear if an optical probe was installed and enabled.

Select **Esc** or press **0** to exit discrete sampling.

UNATTENDED SAMPLING

Select **2-Unattended Sampling** from the Run menu. The Unattended sample menu will be displayed. Use the following example to understand the unattended sampling option.

Example: You are going to deploy the sonde for 2 weeks, collecting a set of readings every 15 minutes. You start at 6:00 PM on July 17, 1996 and end the sampling at 6:00 PM on July 31, 1996. The site is Clear Lake, near the spillway, and you want to log all of the readings to a single file CLRLAKE3.

```

-----Unattended setup-----
1-Interval=00:15:00
2-Start date=07/17/96
3-Start time=18:00:00
4-Duration days=365
5-File=
6-Site=
7-Bat volts: 11.6
8-Bat life 25.1 days
9-Free mem 41.3 days
A-1st sample in 8.10 minutes
B-View params to log
C-Start logging

```

Follow the prompts on this screen to prepare your 600XLM, 6600, 6920 or 600 OMS (battery version) sonde for unattended deployment as described below:

To verify and/or correct the time and date enter **4-Status** or **5-System menu** from the Main menu. You may enter the correct date and time from either of these submenus.

- Select **1-Interval** and enter the desired time between samples (e.g. 15 minutes in the screen above). Use the 24-hour clock format to enter interval.
- Select **2-Start Date** and **3-Start Time** to set the time that data will begin to log to sonde memory. If you do not make any change to these entries, then the study will automatically begin at the next integral time interval, once you have pressed **C-Start logging**.

Example: If the current time is 17:20:00 and your sample interval is 15 minutes, logging will automatically begin at 17:30:00.

It is better to start the study prior to taking the unit to the field so that you can confirm that readings are being saved to memory. If you should desire to start the instrument at the site at 6:00 PM as noted in the above example, change the Start Time to 18:00:00.

- Select **4-Duration** and set the length of the study in days. The default value is 365 days (which is longer than most deployments). In most cases, you will either want to stop the unattended study manually or allow the batteries to be expended. It is wise to set the duration to a value longer than the anticipated deployment. If you cannot retrieve the sonde at the expected time due to factors beyond your control such as weather or illness, data will continue to be acquired as long as battery power is present.
- Select **5-File** and enter a name of no more than 8 characters that will be used by your external computer to identify the study. Be sure to use **ONLY** alpha/numeric characters.
- Select **6-Site** and enter a site name of no more than 31 characters. This filename will appear in your sonde file directory, but will not be used to identify the file after transfer to your computer.
- Check **7-Battery** to make certain that the voltage is suitable for the length of the study that you are about to begin. No change can be made to this item via the software.

- Skip **B-View params to log** in this initial test study. This feature will be explained in detail in **Section 2.9, Sonde Menu**.

After making the above entries, the sonde software will automatically calculate the expected battery life, and the time it will take for the sonde memory to be filled. This information is displayed on the screen for your consideration as items 8, 9, and A. If the battery life or the free memory capacity will be exceeded sooner than the duration, you may want to make some changes to the entries. For example, you can free up memory in the sonde by uploading all existing data from the sonde memory to your PC and then deleting them out of the sonde (see 3-File from Main Menu). You may want to change the batteries for longer battery life. You can lengthen the sampling interval to extend both battery life and memory capacity.

Review the screen below, which now displays the entries made above and reflects your logging conditions.

```

-----Unattended setup-----
1-Interval=00:15:00
2-Start date=07/17/96
3-Start time=18:00:00
4-Duration days=365
5-File=clrlake3
6-Site=Clear Lake at Spillway
7-Bat volts: 11.6
8-Bat life 25.1 days
9-Free mem 41.3 days
A-1st sample in 4.10 minutes
B-View params to log
C-Start logging

```

Once you press **C-Start logging**, a screen will appear to request confirmation.

```

-----Start logging-----
Are you sure?
1-Yes
2-No

Select option (0 for previous menu):

```

Select **1-Yes** and the screen will change.

```
-----Logging-----  
1-Interval=00:15:00  
2-Next at 07/17/96  
3-Next at 18:00:00  
4-Stop at 07/31/96  
5-Stop at 18:00:00  
6-File=clrlake3  
7-Site=Clear Lake at Spillway  
8-Bat volts: 11.7  
9-Bat life 25.5 days  
A-Free mem 41.3 days  
B-Stop logging  
  
Select option (0 for previous menu):
```

The display now shows the next date and time for logging, and the stop date and time for the logging study. Most importantly, note that the bottom command now shows **B-Stop logging**, a confirmation that the logging has indeed been initiated.

The Unattended study will terminate when the duration you specified has expired or the batteries are expended. If you want to terminate sooner, simply select **2-Unattended** sample from the Run menu, then **B-Stop logging**. Select **1-yes** and return to the Unattended setup menu.

```
Stop logging?  
1-Yes  
2-No  
  
Select option (0 for previous menu):
```

2.8 USING ECOWATCH TO CAPTURE, UPLOAD AND ANALYZE DATA

CAPTURE

EcoWatch for Windows can be used to capture data in real-time to your PC's hard drive or to a floppy disk. To utilize this function, interface the sonde to your PC via a COM port, run EcoWatch for Windows, and follow the step by step instructions below.

1. Click on the sonde icon , choose the proper Com port, and confirm.
2. From the **Main** sonde menu press **1-Run** and then **1-Discrete Sample**.
3. Make sure that the sample interval is set to the correct value. If it is not, change it to the correct value.
4. Close the terminal window by clicking on the **X** in the upper right hand corner. Do not close EcoWatch for Windows.
5. Open the **Real-Time** menu, click on **New** and select the location where you want to data transferred. Name the file, making sure that the name has extension **.RT**. The default location for the file is in the Data subdirectory of the ECOWWIN directory.
6. Click **OK**. After EcoWatch sets up the sonde for the study, data transfer will begin at the sample rate you selected. The data will be automatically plotted with autoscaling and saved as a .DAT file at your chosen selection.
7. To terminate the study, open the **Real-Time** menu, choose **Close**, and click **OK**.

UPLOAD DATA

EcoWatch for Windows software is reporting and plotting software for use with the YSI 6-Series sondes. Instructions for installing this software were included in **Section 2.1, Getting Started**. This program can also be used to upload and view data logged to sonde memory during either discrete or unattended sampling.

If the sonde was deployed unattended (without a cable), clear debris and water from the bulkhead connector cap. Then remove the cap and connect the calibration cable (or field cable and adapter) from the sonde to your computer.

You may now retrieve data files using the following procedure. Remember these are files in the sonde directory, not files in the EcoWatch directory.

Run EcoWatch software on your PC and select the **Sonde** icon  from the menu bar. A terminal interface window (like that shown below) will appear. If a “#” prompt appears instead of the Main sonde menu, type “menu” at the prompt to generate the display as shown. Then press **3-File** to view data handling options.

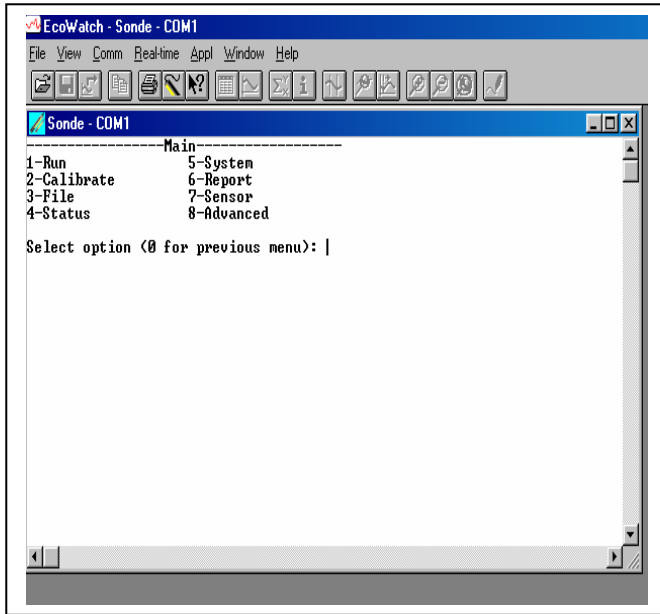

```
-----File-----
-
1-Directory          4-View file
2-Upload            5-Quick view file
3-Quick Upload      6-Delete all files

Select option (0 for previous menu): 1
```

Select **1-Directory** to view all files currently stored in the sondes flash disk memory, the screen below shows 6 files. All data files (.dat extension) could be uploaded to EcoWatch for viewing or plotting, but you do not need to upload all files in the directory. The file with the .glp extension contains the calibration record of the sonde. It is fully described in Sections 2.9.2 and 2.9.3 below. Details of any of the studies can be obtained by pressing the number key associated with the file in the Directory.

```
Filename      Samples
1-BRIDGE1.dat    19
2-BRIDGE2.dat    27
3-UPLAKE.dat     33
4-CLRLAKE2.dat  167
5-DWNLAKE2.dat   31
6-00003001.glp   3

Select option (0 for previous menu): 4
```

```
-----File details-----
-----
1-View file
2-File:CLRLAKE2.dat
3-Samples:      167
4-Bytes:        4421
5-First:08/23/2001
6-First:08:33:40
7-Last :08/23/2001
8-Last :09:04:20
9-Interval:00:00:10
A-Site:Clear Lake
```

Select **2-Upload** to view file lists in memory, and upload the data to PC-based software.

Prior to upload, a “**Time window**” display appears that will allow you to select portions of the logged data to upload. You may select **1-Proceed** to upload all logged data from the dates and times displayed.

```

-----Time window-----
1-Proceed
2-Start date=08/14/96
3-Start time=18:00:00
4-Stop date=08/28/96
5-Stop time=11:00:00

Select option (0 for previous menu):

```

Select **1-Proceed**. Choose the appropriate file transfer protocol (in this example, PC6000) and a status box will show the progress of the upload. Verification of a successful transfer is indicated when all of the requested data have been transferred to the C:\ECOWIN\DATA subdirectory of your PC and automatically assigned a “.DAT” extension.

```

-----File type-----
1-PC6000
2-Comma & ' ' Delimited
3-ASCII Text

Select option (0 for previous menu):

```

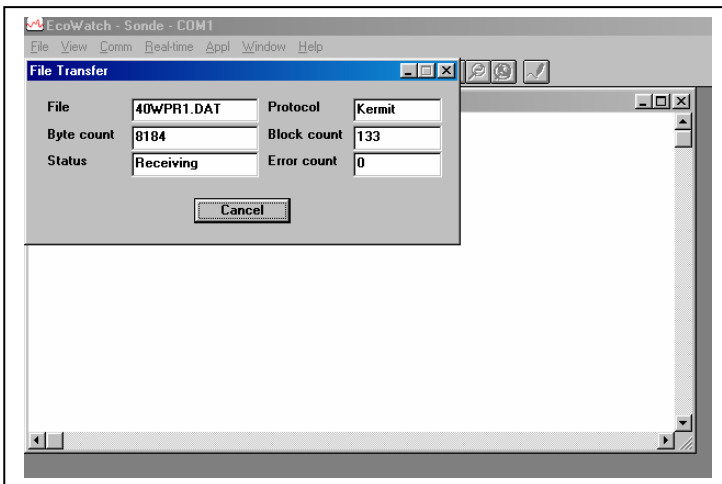

Select **3-Quick Upload** to transfer the last logged file in its entirety to your computer. As noted above, the file will then be resident in the C:\ECOWIN\DATA subdirectory.

Select **4-View File** to examine the data in any file currently stored in the sondes flash disk memory. You will first view the same screen as viewed in the Directory menu. From this menu choose the file of interest, then, using the Time window menu, choose the dates and/or times of interest. If you choose dates or times that are not within the designated start and stop times, no data will be displayed.

You also may choose the entire file. You can use the **Space Bar** to stop and restart the scrolling at any time. Use the **Esc** key to stop the view.

Select **5-Quick view file** to view the last page of data from the last data file in flash disk memory. This feature is particularly useful to quickly review any recently acquired data so that system performance can be assessed.

Select **6-Delete** all files to **IRREVERSIBLY** remove all files (INCLUDING the .glp file that contains calibration information) from the sonde flash disk memory. It is critical not to use this option until all relevant data from sonde memory is transferred to your computer via one of the upload options. There is a verification screen that appears, so that pressing the number 6-key does not immediately delete all files.

REPORTING AND PLOTTING DATA WITH ECOWATCH

There are many features in EcoWatch related to viewing, plotting, manipulating and reporting data collected from a 6-Series sonde. EcoWatch includes a Windows Help section for convenient reference that describes all of the software's features. This section of the manual describes the most commonly used functions of the program and Section 4, **EcoWatch for Windows**, is a detailed manual for EcoWatch software.

For the purposes of describing and demonstrating EcoWatch plotting, reporting and data manipulation capabilities, we use the file SAMPLE.DAT available on the compact disk that was enclosed with your 6-series sonde. This file will be copied to your hard drive during EcoWatch installation and should be available to you for the instructions below.

When you are ready to move beyond the example SAMPLE.DAT file and analyze data collected from the sonde, locate and open the appropriate .DAT file from your data upload exercise. These data are normally found at C:\ECOWWIN\DATA\. An example filename is 1097CM01.DAT.

NOTE: In the instructions below that refer to clicking the mouse button, we always refer to the left mouse button unless otherwise specified.

OPENING A DATA FILE

If EcoWatch is not running, open the program by double clicking on the EcoWatch icon. Click on **File** to view a drop-down menu similar to the one shown in the figure below. From this menu click on **Open**, then locate the drive and directory where SAMPLE.DAT (or your file of interest) resides. Alternatively, if you have been using EcoWatch during setup and checkout, you may be able to click on the file of your choice in the most recently opened files.

Once the SAMPLE.DAT file is open you should see a plot, as shown in the figure below, which graphically represents seven days of sonde data for six different water quality parameters plotted as a function of date and time. Each set of data is autoscaled to allow you to see the minimum and maximum values for each parameter during the one-week study.

Opening a File

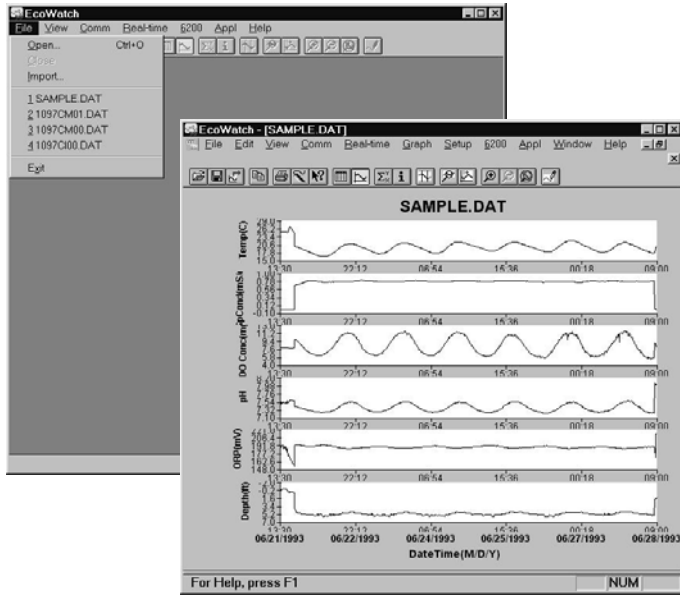

Some daily variations may be noticed in parameters such as dissolved oxygen, pH and temperature in this particular study. This is fairly typical in many natural bodies of water. Note also that conductivity is low at both ends of the graph. You may notice similar perturbations in some of the other readings as well. In this example, the sonde was not in the water for a short time at the beginning and end of the study. Not only can you see exactly when the sonde went in and out of the water, but the bottom graph shows the depth at which the sonde was deployed.

Notice also that you now see a new set of menu items in the top line. Some of these functions are specifically related to viewing and manipulating data. Next we will examine some of the viewing options.

VIEWING DATA

To look at some of the viewing options, click on **View** (see figure below). Note that the Toolbar and Status Bar are turned on (check mark). In addition, the 4-Digit Year expression is checked. Also note that a check mark is just left of the Graph choice. When a check is next to Graph, all data are expressed graphically in the opening window.

To show data in both graphical and data table format, highlight the Table menu item, then click or press **Enter**. The graphical portion of the window becomes compressed, and the data table becomes visible. If you then click on **View** again, both the Graph and Table items have check marks to their left, indicating that both functions are turned on. You may use your mouse to scroll up/down and left/right to view data.

Viewing Options

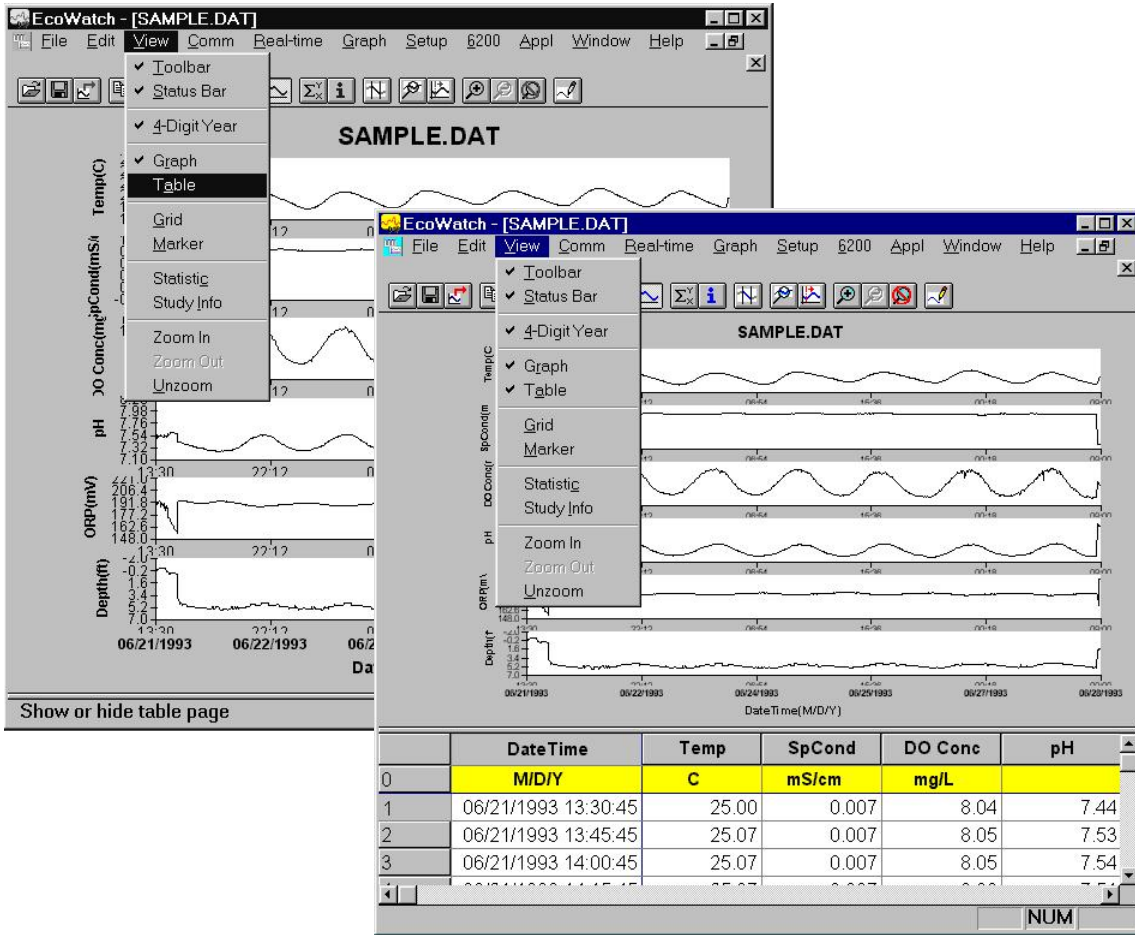

It may be somewhat awkward to scan the data table in this manner; therefore you have the option to turn off the graphical representation and allow the table to fill the window. See the figure below. Notice now that when you click on **View**, the Graph item is no longer checked.

Viewing the Data in Table Format

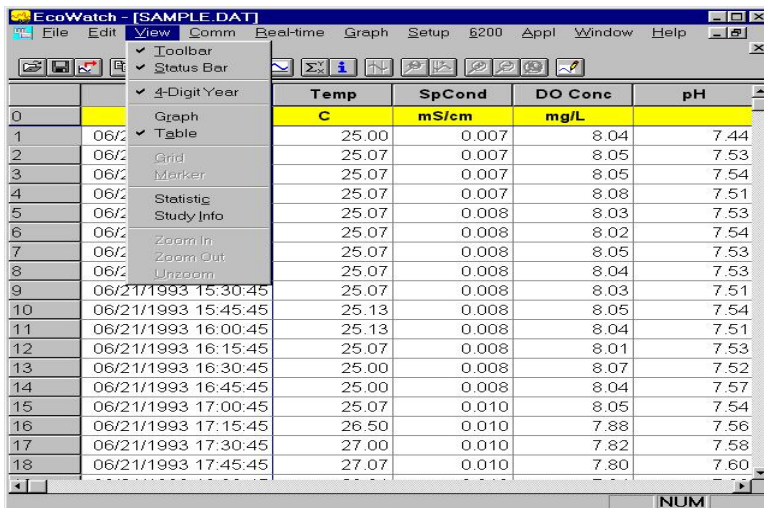

Viewing features such as Grid, Marker, Zoom In, Zoom Out and Unzoom are all available when you activate the **Graph** function. Give each a try as you practice and learn more about the many features of EcoWatch.

The **Statistics** and **Study** functions of EcoWatch are shown in the figure below. Both provide overview information related to the study data. The **Statistics** function lists minimum, maximum, mean and standard deviation information for each parameter activated. The **Study** function provides useful information about the design of the study including sample interval, date/time, number of samples, sensor identification and parameters reported. The Statistics and Study windows may be activated over either graph or table presentations.

To view either of these windows, click on **View**, highlight the desired function and click again. The window opens on top of the table or graph, similar to what is shown in the figure below. Only one of these windows may open at one time. To continue, you must close the Statistics or Study window to return to the graph or table and activate the top line menu again.

As before practice viewing the functions mentioned above to gain more familiarity with these features.

Statistics and Study Information

The screenshot shows the EcoWatch software interface. The main window displays a data table with columns for Temp (C), SpCond (mS/cm), DO Conc (mg/L), and pH. The 'View' menu is open, showing options like Table, Grid, Marker, and Statistic. The 'Statistic' window is open, showing summary statistics for 655 samples from 06/21/1993 13:30:45 to 06/28/1993 09:00:45. The 'Study Info' window is also open, showing instrument details (Model: 6000, ID: <None>, Revision: 1.04) and logging settings (Site Name: srus15n2, Rate: 15 Mins, Duration: 6 Days, 19 Hrs. 30 Mins).

	Temp	SpCond	DO Conc	pH
	C	mS/cm	mg/L	
0				
1	06/21/1993 15:30:45	25.00	0.007	8.04
2	06/21/1993 15:45:45	25.07	0.007	8.05
3	06/21/1993 16:00:45	25.07	0.007	8.05
4	06/21/1993 16:15:45	25.07	0.007	8.05
5	06/21/1993 16:30:45	25.07	0.007	8.05
6	06/21/1993 16:45:45	25.07	0.007	8.05
7	06/21/1993 17:00:45	25.07	0.007	8.05
8	06/21/1993 17:15:45	25.07	0.007	8.05
9	06/21/1993 17:30:45	25.07	0.007	8.05
10	06/21/1993 17:45:45	25.07	0.007	8.05
11	06/21/1993 18:00:45	25.07	0.007	8.05
12	06/21/1993 18:15:45	25.07	0.007	8.05
13	06/21/1993 18:30:45	25.07	0.007	8.05
14	06/21/1993 18:45:45	25.07	0.007	8.05
15	06/21/1993 19:00:45	25.07	0.007	8.05
16	06/21/1993 19:15:45	25.07	0.007	8.05
17	06/21/1993 19:30:45	25.07	0.007	8.05
18	06/21/1993 19:45:45	25.07	0.007	8.05

655 Samples From (06/21/1993 13:30:45) To (06/28/1993 09:00:45)				
	Min	Max	Mean	Std
Temp (C)	16.53	27.07	19.82	1.779
SpCond (mS/cm)	0.01	0.82	0.75	0.164
DO Conc (mg/L)	5.45	11.77	8.42	1.879

Instrument		Sample	
Model	6000	Total samples	655
ID	<None>	First sample	06/21/93 13:30:45
Revision	1.04	Last sample	06/28/93 09:00:45

Parameters		Logging	
Battery		Site Name	srus15n2
Cond		Rate	15 Mins
Depth		Duration	6 Days, 19 Hrs. 30 Mins
DO%			
ORP			
pH			
Temp			

Next, with the Statistics and Study windows closed, return to the **View** menu, close **Table** and activate **Graph**.

Using the right mouse button, click at any point on the graph. A dotted vertical line appears along with specific data values in boxes to the left of the displayed graphs, as shown in the figure below. You can hold down the right mouse button and move the mouse to scan the entire graph that is displayed in the window. The values in the boxes change as you move the mouse. This feature is very useful for quantifying specific data without the need to open the data table and scroll through what may be thousands of data points. Note also that the exact time and date change to let you know specifically when an event of interest occurred.

Viewing the Data with Right-Button Mouse Function

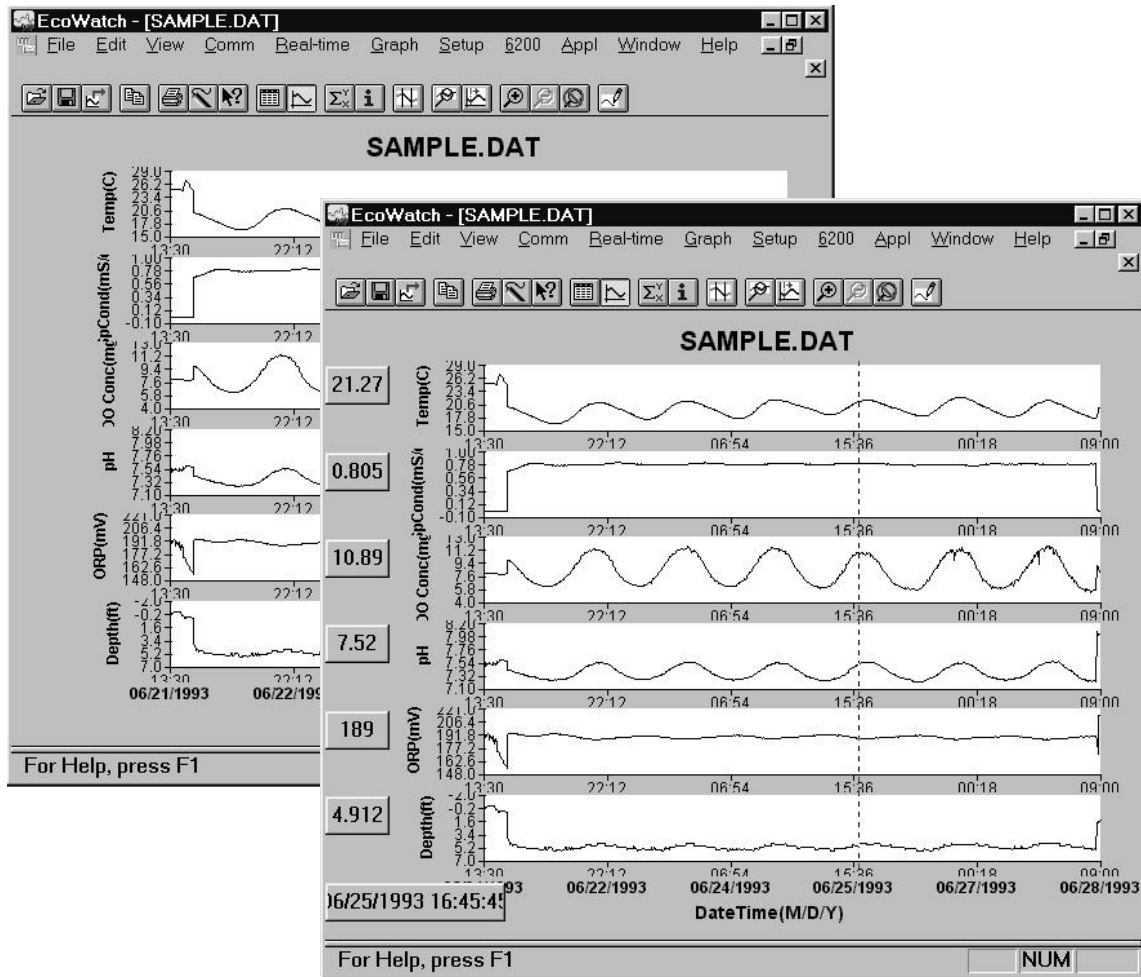

CHANGING DISPLAY FORMATS USING SETUP

Beyond selecting data viewing options such as table format or graphical format, you may also customize your data displays. For example, you may change the order in which parameters are viewed, you may add and delete parameters, you may change plot appearance using different interval times and different units, and you may change the x-axis if you prefer a parameter other than date or time.

The Top Line menu selection that allows you to select some of these parameter changes is **Setup**. Click on **Setup**, then **Parameters**. From here there are four submenus that allow you to Add/Remove parameters, change Units, change sample interval and/or x-axis (Attributes) and change the Names of the parameters you have assigned, as shown in the figure below.

Changing the Appearance of a Graph or Table

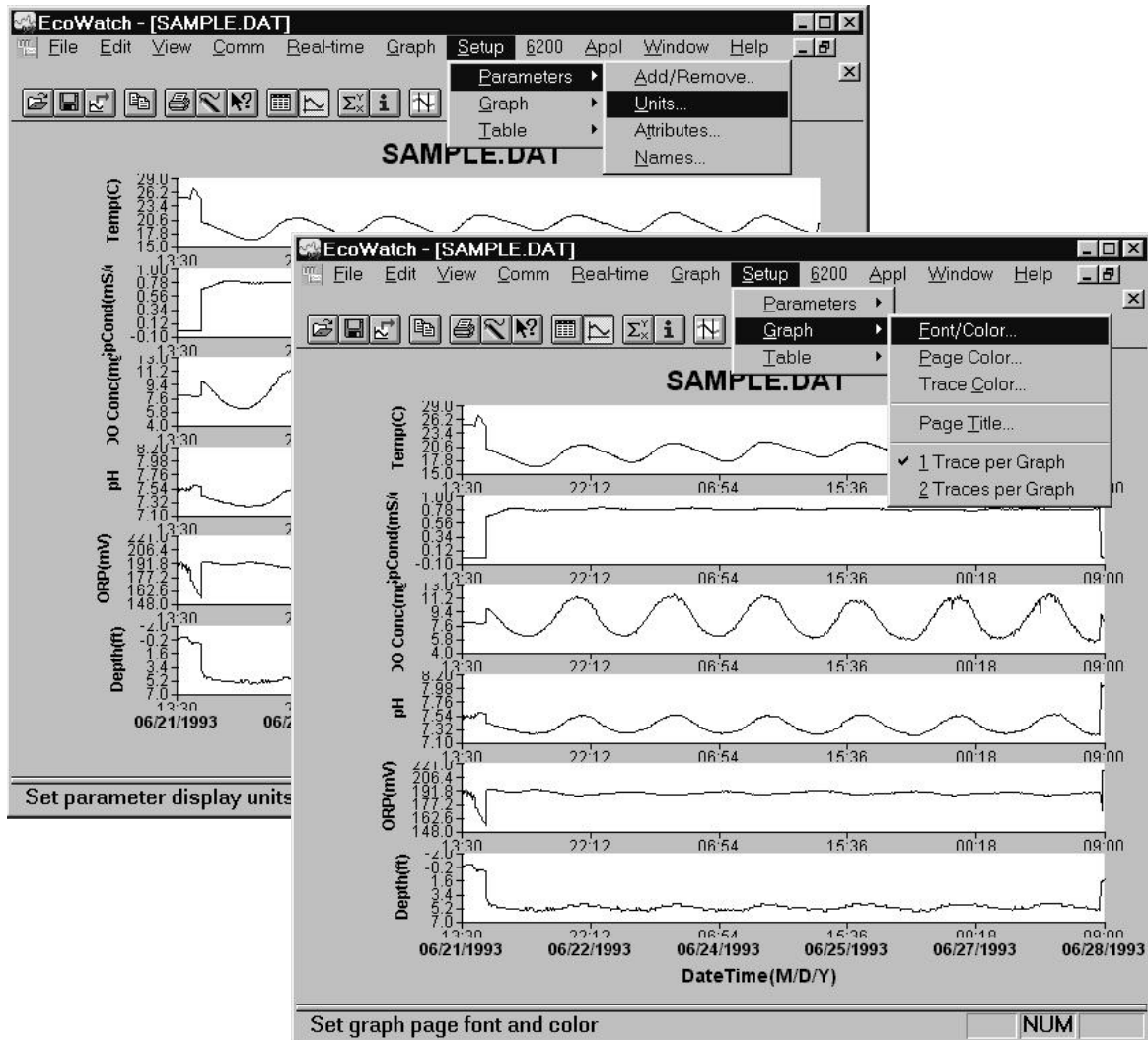

If you are displaying the graph, you may change the appearance by changing font, font style, size and text color. You may also change page color, trace color and graph background color. You may assign a custom 2-line title for the graph, and finally, you may display 1 trace or 2 per set of axes. For display of table formatted results you may change font, font style, size and text color. In addition, you may change table color and highlight color.

The menu structure is easy to follow. Try some changes to gain familiarity with these **Setup** display options.

CHANGING DISPLAY FORMATS USING 'GRAPH' FUNCTION

The top line menu labeled **Graph**, as the name suggests, can be used to examine critical events within the graphical format. You may be able to more clearly understand an event by zooming in/out, centering an event of interest, and setting limits to focus in on a specific area of the graph. In addition to modifying along the x-axis, you may also manually scale the y-axis. This may allow you to discard a noise spike and obtain better resolution of events unrelated to the noise. Functions like Autoscale, Redraw and Cancel Limits are all used to “undo” some of the customization functions. You will see some of these functions in the figures below.

One very commonly used function is **Limit Data Set**. If you choose this function by clicking on the highlighted item as shown below, you then use the mouse to move your cursor to the left limit of an area of interest, click once, then move the mouse to the right limit of interest and click again. The result will be a close up look at the specific area of the graph you have defined.

Selecting a Subset of Data within a Graph

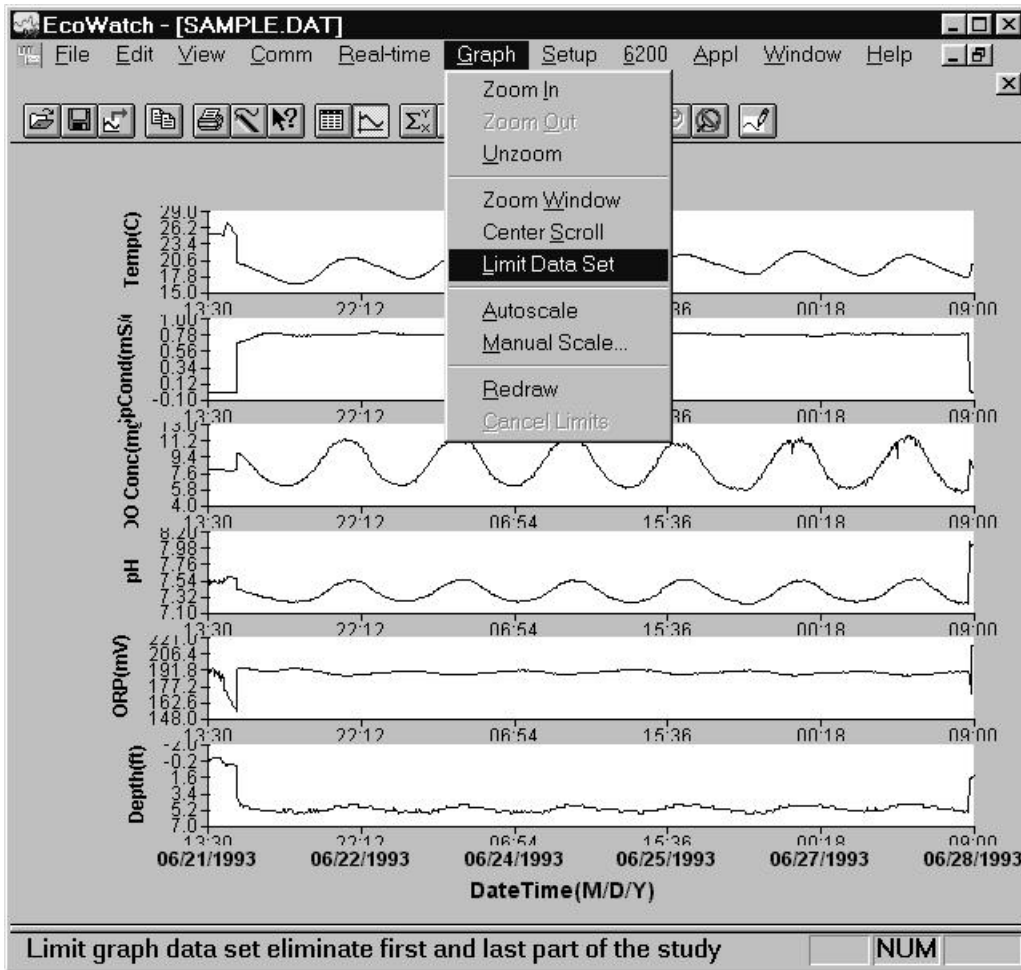

Using Limit Data Set to Display a Subset of Data

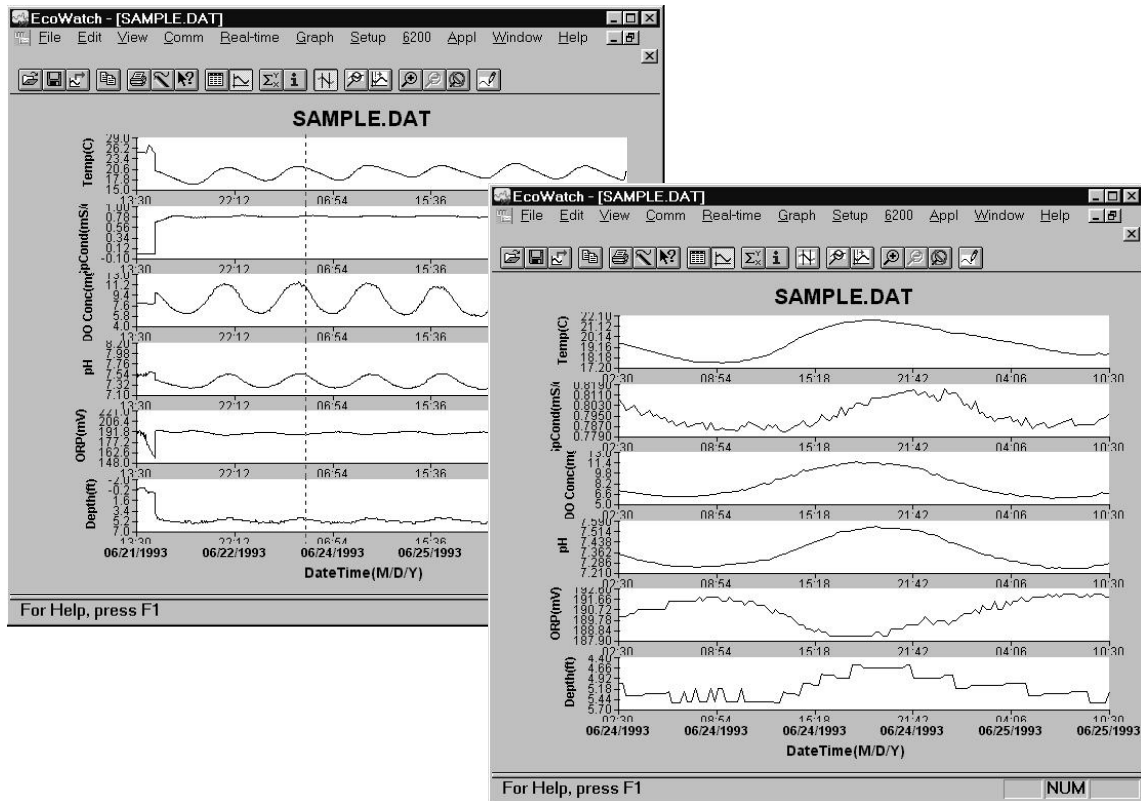

To return to the full set of data again, click on **Graph**, then **Cancel Limits**. If you desire a hard copy of any graph or table, or even a subset expression as shown above, you may use the **Edit, Copy** command to 'copy' the graph in the active window to the "Clipboard". You can then 'paste' this graph to the Windows application program of your choice. You may also be able to print graphs and tables as described in the next section.

SAVE, IMPORT, EXPORT AND PRINT COMMANDS

Under **File** function in the top line menu, you can save a particular presentation version of a data file and give the presentation a customized name. For example, you might want to call the expanded plot in the figure above "DIURNAL" using the **File|Save Data Display** command. This presentation will be saved with your data file and can be recalled in further by using the **File|Load Data Display** command. You can also export your custom data display as a spreadsheet compatible file (.CDF or .TXT) or print it to a compatible printer. You may also create a custom report format using **the File|Report** command. See the figure below for the **File** menu, which shows these commands. Use the Window's Help function to learn more about these features.

Saving, Exporting, Printing and Related Functions

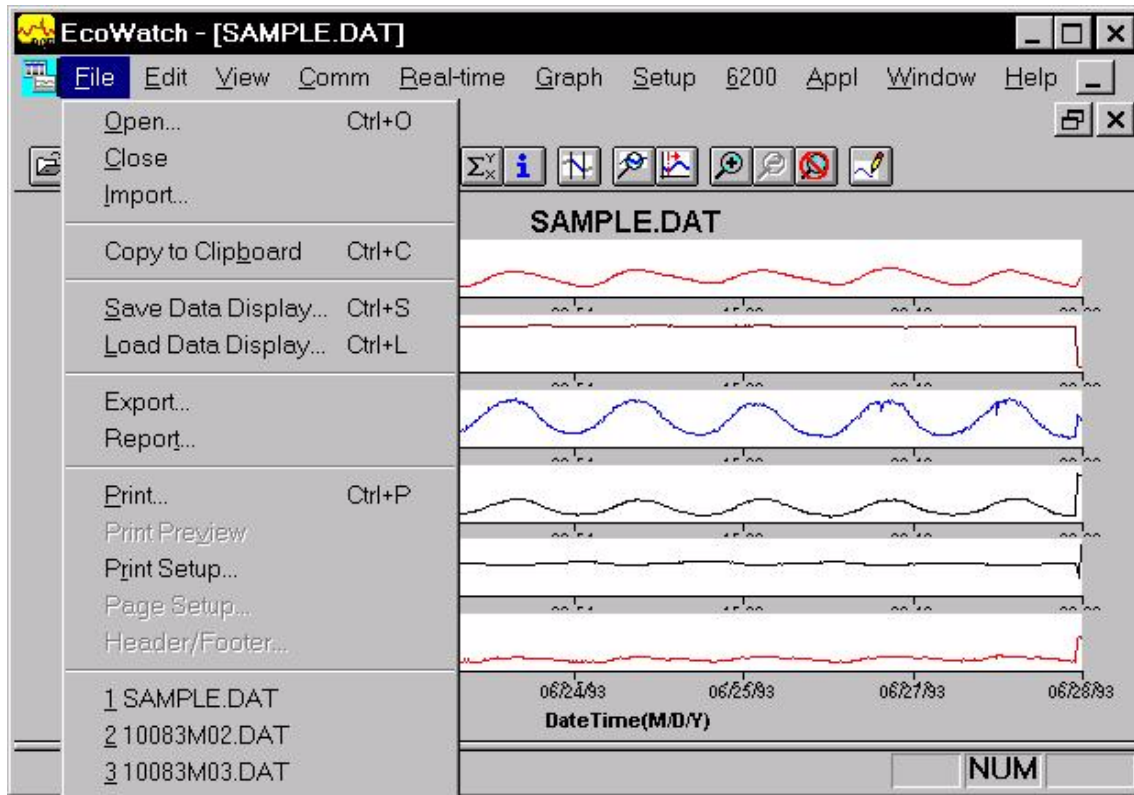

EXAMPLE OF CUSTOMIZING A SUBSET OF SAMPLE.DAT

To conclude this section we have used a few of the many tools available in EcoWatch to demonstrate how you might use this powerful plotting and reporting program to express study results. We encourage you to try some of the tools and learn more about EcoWatch by using the Window's Help function, which is available when the EcoWatch program is running.

Using SAMPLE.DAT we decided that some of the data were not of particular interest, so using top line menu item **Setup**, then **Parameters**, then **Add/Remove**, we removed ORP and Depth results from the data set. Note that we have not deleted this information from the file, but rather we are choosing not to display it. You can always return to this function and add original data back. Under the same **Parameters** function, we have selected **Attributes** and changed the Average Interval from the default **0** to **60**. Since data was collected every 15 minutes, the change to a 60 minute interval helps to smooth out the graph and average out any short term "noise" events.

Next, we again select **Setup**, then **Graph**. From the functions available, we first selected **Title Page...** and typed in a name (Clear Lake Study #2) and below that we typed the parameters that are shown in the graph. Just below **Title Page**, we clicked on **2 Traces per Graph**. This combines adjacent parameters which is sometimes useful in parameter and event evaluation. For example, in the second graph shown in the figure below, you see that DO concentration and pH seem to track rather closely and change in a diurnal rhythm. In actuality, when DO levels drop in a natural body of water, CO₂ often builds up forming carbonic acid which leads to lower pH readings. DO rises again during the day due to photosynthesis, CO₂ then falls and pH increases again. The final plot after making these changes is shown in the figure below.

Customizing a Graph from SAMPLE.DAT

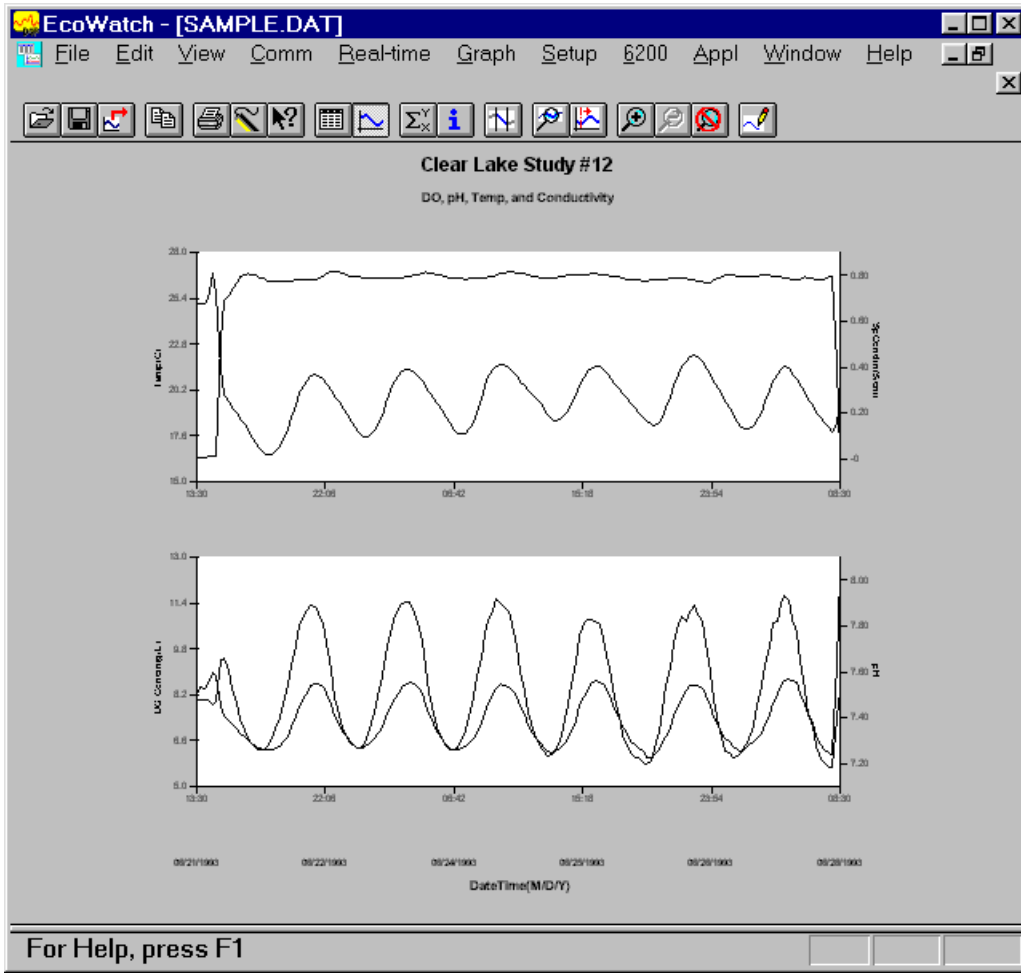

Finally, we selected **File|Save Data Display** and gave the custom plot the name “4PARAM” to that the presentation can be immediately recalled in the future.

As you become more familiar with EcoWatch for Windows, the plotting, analysis and reporting functions can be accomplished easily and quickly. Practice with all of the functions and, again, do not forget to use Window’s Help for more detail, or see Section 4, **EcoWatch for Windows**.

2.9 SONDE MENU

The functions of the sondes are accessible through the sonde menu. The sonde menu structure makes it simple and convenient to select functions. This section provides a description of the menus and their capabilities.

When moving between menus within the sonde software structure, use the **0** or **Esc** to back up to the previous menu. To exit menus and return to the sonde command line (the # sign), press **0** or **Esc** until the question “**Exit menu (Y/N)?**” appears. Type **Y** and the command prompt (“#”) will be shown. To return to the Main sonde menu, type **menu** and press **Enter**. To return to the Main menu of the sonde, type “menu” after the “#” and press **Enter**.

IMPORTANT MESSAGE! WHAT IF THERE IS NO RESPONSE TO A KEYSTROKE?

To save power, the sondes will power down automatically if no interaction from the keyboard occurs for approximately 60 seconds when an Autosleep function (RS232 or SDI12) is activated in the **Advanced Setup** menu. When the software is in this “sleep” mode, the first subsequent keystroke simply “wakes it up” and has no visible effect on the display. The next keystroke after the unit is “awakened” will be input to the software in the intended manner. Thus, if you press a key after the sonde has been inactive for some time and nothing seems to happen, press the key again.

To gain experience with the sonde menus, select the sonde icon in EcoWatch for Windows and press **Enter**. See the figure below for the Sonde Menu Flow Chart.

In the following subsections you will learn about the functions of the various menu items and when to use them. The discussion of the menu and submenu functions is organized in numerical order, beginning with **Section 2.9.1 RUN**.

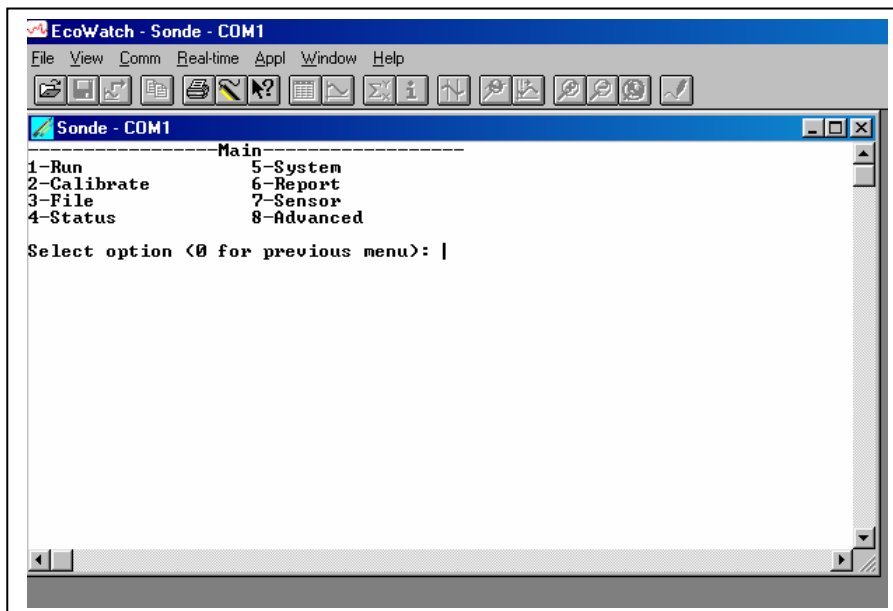

2.9.1 RUN

Select **1-Run** from the Main menu to begin taking readings or to set/verify the parameters required for a study. There are two options in the Run menu.

```
-----Run setup-----  
1-Discrete sample  
2-Unattended sample  
  
Select option (0 for previous menu): 1
```

DISCRETE SAMPLING

Discrete sampling is usually used in short term, spot sampling applications when the user is present at the site and the unit is attached to a data logger or laptop PC. It could be used in the vertical profiling of a lake or river where the user lowers the sonde incrementally into the water, and data acquired for a few minutes at each depth. In this section, you will learn how to use the sonde menu structure to open and close files, set the interval between samples, start the sampling operation, and log data to the internal memory of the sonde.

Select **1-Discrete sample** from the Run menu. The Discrete sample menu will be displayed.

```
-----Discrete sample-----  
1-Start sampling  
2-Sample interval=4  
3-File=  
4-Site=  
5-Open file  
  
Select option (0 for previous menu):
```

Select **1 – Start sampling** option to start discrete sampling. After the initial sampling time interval has passed (4 seconds in the screen above), sequential lines of data will appear on the screen.

Date	Time	Temp	SpCond	Sal	Cl2	Depth	pH	Turbid	Battery
mm/dd/yy	hh:mm:ss	C	mS/cm	ppt	mg/L	feet		NTU	volts
*** 1-LOG last sample 2-LOG ON/OFF, 3-Clean optics***									
05/05/97	10:04:40	21.57	0.009	0.00	0.95	-0.293	7.55	0.3	10.2
05/05/97	10:04:44	21.57	0.009	0.00	0.96	-0.300	7.55	0.3	10.3
*** LOG is ON, hit 2 to turn it OFF, 3-Clean optics***									
05/05/97	10:04:48	21.58	0.009	0.00	0.95	-0.302	7.55	0.3	10.3
05/05/97	10:04:52	21.58	0.009	0.00	0.95	-0.302	7.55	0.3	10.3
05/05/97	10:04:56	21.58	0.009	0.00	0.95	-0.303	7.55	0.3	10.2
05/05/97	10:05:00	21.58	0.009	0.00	0.96	-0.303	7.55	0.3	10.3
*** 1-LOG last sample 2-LOG ON/OFF, 3-Clean optics***									
05/05/97	10:05:04	21.58	0.009	0.00	0.96	-0.304	7.55	0.3	10.3
Sample logged.									
05/05/97	10:05:08	21.58	0.009	0.00	0.95	-0.305	7.55	0.3	10.3

The following prompt will appear just below the screen header:

1-LOG last sample, 2-LOG ON/OFF, 3-Clean optics

- By entering **1-LOG last sample**, A single line of data can be logged to sonde memory and the following message will be displayed: **Sample logged.**
- By entering **2-LOG ON/OFF**, a set of data can be logged to memory and the following message will be displayed: **LOG is ON, hit 2 to turn it OFF, 3-Clean optics.** Press **2** again to terminate logging.
- By entering **3-Clean optics**, if your unit has an optical (turbidity, chlorophyll or rhodamine WT) probe, the wiper will clean the optical surface. The **3-Clean optics** portion of the prompt will only appear if an optical probe was installed and enabled.

Select **Esc** or press **0** and return to the Discrete Sampling menu.

From the Discrete Sampling menu, select **2-Sample Interval** to type a number that represents the number of seconds between samples. The maximum sample interval is 32767 seconds (9+ hours). The factory default sample interval is 4 seconds and works best for most discrete sampling applications. The shortest possible sample interval for obtaining new free chlorine readings is 4 seconds. If a smaller interval is selected, then the Cl2 readings remain constant for the number of samples necessary to fill 4 seconds.

NOTE: If your have used your sonde with a 650 MDS data logger, the Sample Interval automatically be changed to 0.5 seconds.

Sampling Faster Than 0.5 Seconds

For special applications, your sonde is capable of faster sampling. The only limitation is a reduction of the number of sensors selected. To determine the maximum sampling frequency for your sensor setup, divide 36 by the number of enabled sensors in addition to the free chlorine sensor.

Example:

If you enable any three sensors plus DO, divide 36 by 3 to obtain 12 samples/second (12 Hz) or 0.083 seconds between samples as the maximum sampling frequency. Remember that for sample intervals less than 4 seconds, free chlorine readings are updated only every 4 seconds. Thus, at 12 Hz, the display will show 48 identical Cl₂ readings before a change occurs. Note also that at a faster sampling rate, consecutive readings are closer together, the threshold for any one sensor is less likely to be exceeded, and the data filter is less likely to disengage. For these applications you may want to adjust your threshold settings accordingly. See Section 2.9.8 for more information on the data filter.

Select **3-File** to enter a filename with a maximum of 8 characters. You will log readings to the filename that you enter.

If you started sampling without entering a filename, the default name NONAME1 will be assigned to your file. Whenever you press **1-LOG last sample** or **2-LOG ON/OFF** from the menu, NONAME1 will be opened during sampling. If this happens, and you want to restart the file with a different name, press **5-Close file** and rename the file.

Select **4-Site** to assign a site name with a maximum of 31 characters. This allows you to enter the name of the site where you are sampling.

When you select **5-Open File**, a file is opened and the number 5 changes to **Close File**. When you are finished logging data to the file, press **5-Close File** and designation changes back to **Open File**. When you start logging the **Open File** designation changes automatically to **Close File**.

Now select **1-Start sampling** to start discrete sampling.

After the initial sampling time interval has passed, sequential lines of data will appear on the screen and you can log single or sequential data points and wipe the surface of your optical probe as described above.

UNATTENDED SAMPLING

This option is used for long-term deployment of the battery-powered sonde when the user is not present at the site. Prior to this selection, the sonde is usually attached to a computer in a laboratory and set up to automatically log data to sonde memory at a fairly long time interval (15-60 minutes). The unit is then taken to the field site and left for an extended time period (30 – 60 days). When the study is complete, or the batteries are expended, the unit is brought back to the laboratory and the data file is uploaded to a computer. Quality assurance checks are performed prior to redeployment.

Select **2-Unattended Sampling** from the Run menu. The Unattended sample menu will be displayed. Use the following example to understand the unattended sampling option.

```

-----Unattended setup-----
1-Interval=00:15:00
2-Start date=07/17/96
3-Start time=18:00:00
4-Duration days=14
5-File=clrlake3
6-Site=Clear Lake at Spillway
7-Bat volts: 9.1
8-Bat life 21.2 days
9-Free mem 18.9 days
A-1st sample in 8.10 minutes
B-View params to log
C-Start logging

```

Follow the prompts on this screen to prepare your 600XLM, 6600, 6920, or 600 OMS (battery version) sonde for unattended deployment as described below:

- Verify that the current time and date are correct to ensure that your unattended sampling study begins and ends when you desire. To verify correct the time and date, return to the Main menu and enter **4-Status** or **5-System**. You may enter the correct date and time from either of these submenus.
- Select **1-Interval** and enter the desired time between samples. Use the 24-hour clock format to enter interval.
- Select **2-Start Date** and **3-Start Time** to set the time that data will begin to log to sonde memory. If you do not make any change to these entries, then the study will automatically begin at the next integral time interval once you have pressed **C-Start logging**.

Example: If the current time is 17:20:00 and your sample interval is 15 minutes, logging will automatically begin at 17:30:00.

It is better to start the study prior to taking the unit to the field so that you can confirm that readings are being saved to memory and carry out initial quality assurance measurements. However, if your study demands that you start the instrument at the site at 6:00 PM, change the Start Time to 18:00:00.

- Select **4-Duration** and set the length of the study in days. The default value is 365 days (which is longer than most deployments). In most cases, you will either want to stop the unattended study manually or allow the batteries to be expended. It is wise to set the duration to a value longer than the anticipated deployment. If you cannot retrieve the sonde at the expected time due to factors beyond your control such as weather or illness, data will continue to be acquired as long as battery power is present.
- Select **5-File** and enter a name of no more than 8 characters that will be used by your external computer to identify the study. Be sure to use **ONLY** alpha/numeric characters.
- Select **6-Site** and enter a site name of no more than 31 characters. This filename will appear in your sonde file directory, but will not be used to identify the file after transfer to your computer.
- Check **7-Battery** to make certain that the voltage is suitable for the length of the study that you are about to begin. No change can be made to this item via the software.

- Select **B-View Parameters to log** to confirm that your sensor and report setups are configured correctly as described in Sections 2.9.6 and 2.9.7. An example screen is shown below.

```

-----Params to log-----
1-Temp C           6-Orp mV
2-Cond mS/cm      7-NH4+ N mg/L
3-Cl2 mg/L        8-NO3- N mg/L
4-Cl2chrg         9-Turbid NTU
5-pH              A-Battery volts

Select option (0 for previous menu):

```

In some cases, the **View params to log** screen only identifies the raw parameters that are used in the calculation of the items that you have selected in the Report setup.

Example: If specific conductance is selected in the Report setup, it does not appear under **Parameters to log** because it is calculated from Conductivity and Temperature. In all but a few cases, the proper configuration of **Parameters to log** will be automatically set up as long as the sensor is enabled.

There are several items that must be activated in the Report setup so they will be available from the file after upload. These special parameters are: Cl₂ Chg, pH mV, NH₄⁺ mV, NO₃⁻ mV, Cl⁻ mV, and Fluorescence %FS. If you want to log any of these parameters to your data file, be certain that they are active in the Report setup before you begin the unattended study.

After making the above entries, the sonde software will automatically estimate the expected battery life, and the time it will take for the sonde memory to be filled. This information is displayed on the screen for your consideration as items 9 and A. If the battery life or the free memory capacity will be exceeded sooner than the duration, you may want to make some changes to the entries. For example, you can free up memory in the sonde by uploading all existing files from the sonde memory to your PC and then deleting them from the sonde (see **3-File** from Main Menu). You may want to change the batteries for longer battery life. You can lengthen the sampling interval to extend both battery life and memory capacity.

The predicted battery life is an estimate only. The temperature of the site and the brand of batteries used can affect battery life. It is recommended to recover the sonde earlier than the predicted battery life, and to use new batteries for each deployment.

Once you press **C-Start logging**, the following screen will appear.

```

-----Start logging-----
Are you sure?
1-Yes
2-No

Select option (0 for previous menu):

```

Select **1-Yes** and the screen will change.

```

-----Logging-----
1-Interval=00:15:00
2-Next at 07/17/96
3-Next at 18:00:00
4-Stop at 07/31/96
5-Stop at 18:00:00
6-File=clrlake3
7-Site=Clear Lake at Spillway
8-Bat volts: 9.0
9-Bat life 21.2 days
A-Free mem 18.9 days
B-Stop logging

Select option (0 for previous menu):

```

The display now shows the next date and time for logging and the stop date and time for the logging study. Most importantly, note that the bottom command now shows **B-Stop logging**, a confirmation that the logging has indeed been initiated.

The Unattended study will terminate when the duration you specified has expired or the batteries are expended. If you want to terminate sooner, simply select **2-Unattended** sample from the Run menu, then **B-Stop logging**. Select **1-Yes** and return to the Unattended setup menu.

```

Stop logging?
1-Yes
2-No

Select option (0 for previous menu):

```

2.9.2 CALIBRATE

All of the sonde sensors (except temperature) require periodic calibration to assure high performance. However, the calibration protocols for free chlorine are significantly different depending on whether the sonde is being set up for spot sampling or longer term unattended monitoring studies. This difference is user-selectable and is required primarily because the optimal performance of the free chlorine sensor cannot be attained unless the control of this sensor varies from short term to long term applications.

For spot sampling it is best to pulse the sensor continuously during the Run mode to attain the most accurate results and optimize the response time. However, this continuous pulsing is not ideal for longer term logging studies in which the sonde data is captured to sonde memory or to a data collection platform at much less frequent intervals (e.g. 15 minutes). Continuous pulsing not only shortens the time between required probe maintenance, but consumes more power. With proper selection of the “Auto sleep” option (discussed in detail in **Section 2.9.8, Advanced Menu**), the user can configure the sonde software to either run continuously or “go to sleep” between samples to minimize free chlorine probe wear and conserve power. The effect of this choice on the user interface relative to free chlorine calibration is significant as described below:

- ❑ If “Auto sleep” is **deactivated**, the sonde runs continuously no matter what sample interval has been selected. Under these conditions, the user retains manual control of the free chlorine calibration routine, viewing the stabilization of the readings in real time and confirming the calibration with keyboard entries.
- ❑ If “Auto sleep” is **activated**, the sonde will ‘warm up’ the sensors for the period of time selected for the free chlorine sensor. Under these conditions, the user loses manual control of the free chlorine calibration routine. Free chlorine will automatically calibrate after the selected time for warm up of the Cl₂ sensor has expired. In this mode of calibration, you do not observe stabilization of the readings in real time, but instead will observe a countdown of the warm up period followed by a message indicating that the free chlorine calibration is complete.

Only the calibration of free chlorine is affected by whether “Auto sleep” is on or off; the user retains manual control of the calibration of all other parameters regardless of the “Auto sleep” setting. Once a particular warm up time (in seconds) has been utilized in free chlorine calibration, the length of that time should not be changed during a study. A new calibration should be performed whenever the value of the warm up time is altered.

From the Main sonde menu select **2-Calibrate**. The Calibrate menu will be displayed. Only the enabled parameters will be available for calibration.

```

-----Calibrate-----
1-Conductivity      6-ISE3 NH4+
2-Free Cl2          7-ISE4 NO3-
3-Pressure-Abs     8-ISE5 Cl-
4-ISE1 pH           9-Turbidity
5-ISE2 ORP          A-Chlorophyll

Select option (0 for previous menu):

```

CONDUCTIVITY

Select **1-Conductivity** to calibrate the conductivity probe and a second menu will offer you the options of calibrating in specific conductance, conductivity, or salinity. Calibrating any one option automatically calibrates the other two. After selecting the option of choice (specific conductance is normally recommended), you will be asked to enter the value of the standard used during calibration. Be certain that the units are correct. After pressing **Enter**, you will be able to follow the stabilization of the readings and confirm the calibration when the readings are stable by pressing **Enter** as instructed on the screen. Then, as instructed, press **Enter** again to return to the Calibrate menu.

FREE CHLORINE WITH FOR UNATTENDED STUDIES WITH INTERNAL LOGGING OF DATA

NOTE CAREFULLY: The 6572 free chlorine sensor **MUST** be calibrated *in situ*, i.e. in flowing drinking water whose free chlorine content has been determined by an independent method. In many cases, the independent method involves the use of the DPD Colorimetric Method as defined in Section 4500-Cl G of *Standard Methods for the Examination of Water and Wastewater*. Relatively inexpensive colorimeters, such as the YSI Models 9000 and 9100 and the Hach Model 5870000, are available for carrying out the DPD method to determine the free chlorine in the effluent of the flow cell associated with the 6920DW or 600DW-B drinking water studies.

In most cases, the free chlorine sensor should be calibrated AFTER a logging study has been underway for 2-3 hours to assure the stabilization of the free chlorine sensor in the flowing tap water. The setup of the logging study (or Unattended Sampling) is described in detail in **Section 2.7 UNATTENDED SAMPLING** and **2.9.1 Run UNATTENDED SAMPLING**. To view the logged data to assure stability prior to calibration, see **Section 2.9.3 File**.

To calibrate the free chlorine sensor carry out the following steps:

Following the calibration of all other sensors present, reinstall the free chlorine probe in the sonde bulkhead after removing the port plug. Make certain that no moisture is present in the port before installing the probe and, if moisture is present from the previous calibration procedures, use compressed air to dry the port.

- Break in the sensor according to the instructions in Section 2.6 above.
- Locate the flow cell which was supplied with your 6920DW or 600DW-B and attach it to the sonde according to the instructions that were supplied with the flow cell. Note that for flow cell studies on drinking water with the 600DW-B, YSI recommends that users purchase a 655488 Extended Calibration Cup Sleeve and substitute the extended length sleeve from the calibration cup for the shorter sleeve in the flow cell kit. The extra length will eliminate any bottom interference on the turbidity readings and will be compatible with calibration of the turbidity sensor using the extended length calibration cup.
- Attach inlet and outlet hoses to the barbed fittings supplied with the flow cell and then insert the fittings into the proper ports of the flow cell. Make certain that the hoses are attached very snugly to the barb fittings to prevent any possibility of catastrophic leakage. If necessary, standard hose clamps can be used to secure the hoses to the barbed fittings.
 - Connect the inlet line of the flow cell to a drinking water tap and run the outlet line to a drain. Make certain that the inlet line is securely attached to the tap and that the outline line will not pop out of the drain under flow conditions.
 - Turn on the water to the cell so that the flow is 500-1000 mL per minute (minimum 500 mL/min) and allow water to flow through the cell for at least 1 hour before proceeding.
 - Set up your Unattended Sampling study as described above and allow readings to be logged to internal memory for 2-3 hours. Using the **File|View** command as described in Section 2.9.3, inspect the free chlorine readings and after they are stable proceed with the calibration as described below.
 - Collect a sample of water from the outlet hose of the flow cell and immediately analyze it for free chlorine using an independent method, e.g., the DPD method with a YSI 9100 Photometer.
 - Interface to the sonde using a 650 display/logger or a PC running EcoWatch for Windows. Choose **8-Advanced** and then **2-Setup** and make certain that **Autosleep RS-232** is active as shown in the box below.

```

-----Advanced setup-----
1-(*)VT100 emulation
2-( )Power up to Menu
3-( )Power up to Run
4-( )Comma radix
5-(*)Auto sleep RS232
6-(*)Auto sleep SDI12
7-( )Multi SDI12
8-( )Full SDI12

Select option (0 for previous menu): 0

```

Return to the Main menu using the **Esc** key and select **2-Calibrate** and then **4-Free Cl2**.

At the prompt, input the independently determined free chlorine value and press **Enter**. A display similar to that shown below will appear on either the computer monitor or the 650 display. The calibration will occur automatically after the countdown on the screen reaches zero.

```

=====
Temp SpCond   Sal Cl2   Cl2 Chrg   Depth   pH  NH4+  N  NO3-  N  Turbid
   C   mS/cm   ppt mg/L           feet           mg/L   mg/L   NTU
-----
Stabilizing: 38

```

After the warm-up time is complete, the readings just before and just after calibration are displayed. When you press **Enter**, the screen returns to the Free Chlorine Calibration menu.

FREE CHLORINE WITH SONDE ATTACHED TO 6500 PROCESS MONITOR

See **Appendix G. Using Your Drinking Water Sonde with a YSI**

6500 Process Monitor for enhanced calibration instructions and a detailed description of the Sample and Hold feature.

NOTE CAREFULLY: The 6572 free chlorine sensor **MUST** be calibrated *in situ*, i.e. in flowing drinking water whose free chlorine content has been determined by an independent method. In many cases, the independent method involves the use of the DPD Colorimetric Method as defined in Section 4500-Cl G of *Standard Methods for the Examination of Water and Wastewater*. Relatively inexpensive colorimeters, such as the YSI Models 9000 and 9100 and the Hach Model 5870000, are available for carrying out the DPD method to determine the free chlorine in the effluent of the flow cell associated with the 6920DW or 600DW-B drinking water studies.

In most cases, the free chlorine sensor should be calibrated **AFTER** it has been attached to the 6500 Process Monitor for 2-3 hours to assure the stabilization of the free chlorine sensor in the flowing tap water. See

the manual which was supplied with your 6500 for the setup of the overall system and a description of the displayed information.

To calibrate the free chlorine sensor using a 6500, carry out the following steps:

- Following the calibration of all other sensors present, reinstall the free chlorine probe in the sonde bulkhead after removing the port plug. Make certain that no moisture is present in the port before installing the probe and, if moisture is present from the previous calibration procedures, use compressed air to dry the port.
- Break in the sensor according to the instructions in Section 2.6 above.
- Locate the flow cell which was supplied with your 6920DW or 600DW-B and attach it to the sonde according to the instructions that were supplied with the flow cell. Note that for flow cell studies on drinking water with the 600DW-B, YSI recommends that users purchase a 655488 Extended Calibration Cup Sleeve and substitute the extended length sleeve from the calibration cup for the shorter sleeve in the flow cell kit. The extra length will eliminate any bottom interference on the turbidity readings and will be compatible with calibration of the turbidity sensor using the extended length calibration cup.
- Attach inlet and outlet hoses to the barbed fittings supplied with the flow cell and then insert the fittings into the proper ports of the flow cell. Make certain that the hoses are attached very snugly to the barb fittings to prevent any possibility of catastrophic leakage. If necessary, standard hose clamps can be used to secure the hoses to the barbed fittings.
 - Connect the inlet line of the flow cell to a drinking water tap and run the outlet line to a drain. Make certain that the inlet line is securely attached to the tap and that the outline line will not pop out of the drain under flow conditions.
 - Turn on the water to the cell so that the flow is 500-1000 mL per minute (minimum 500 mL/min) and allow water to flow through the cell for at least 1 hour before proceeding.
 - Connect the drinking water sonde to the 6500 using a YSI 609X field cable. Make sure that readings are displayed on the screen in real-time.
 - Activate the Sample and Hold feature of the software by pressing the **Esc** and **Enter** keys on the 6500 front panel simultaneously and then selecting the **Setup sonde** menu. After activation of the feature, use the arrow keys to set the sample interval.
 - Observe the displayed free chlorine readings for 2-3 hours to assure that they are stable. Then proceed with the calibration as described below.
 - Collect a sample of water from the outlet hose of the flow cell and immediately analyze it for free chlorine using an independent method, e.g., the DPD method with a YSI 9100 Photometer.
 - Press the “Cal” key on the 6500 face plate and then select Free Cl₂. Press **Enter** and then input the correct chlorine value in mg/L as determined by the DPD test. Press **Enter** and the calibration will occur automatically. See the 6500 manual for additional details about the calibration procedure.

pH

When selecting **4-ISE1 pH**, you will be given the choice of 1-point, 2-point, or 3-point calibrations.

Select the **1-point** option only if you are adjusting a previous calibration. If a 2-point or 3-point calibration has been performed previously, you can adjust the calibration by carrying out a one point calibration. Immerse the sonde in a buffer of known pH value and press **Enter**. You will be prompted to type in the pH value of the solution. Press **Enter** again, and the screen will display real-time readings that will allow you to determine when the pH and temperature readings have stabilized. Pressing **Enter** will confirm the calibration. Then, as instructed, press **Enter** again to return to the Calibrate menu. This calibration procedure adjusts only the pH offset and leaves the previously determined slope unaltered.

Select the **2-point** option to calibrate the pH probe using only two calibration standards. In this procedure, the pH sensor is calibrated using a pH 7 buffer and pH 4 buffer. A two point calibration procedure (as opposed to a 3-point procedure) can save time if the pH of the media being monitored is known to be either basic or acidic. For example, if the pH of a pond is known to vary between 5.5 and 7, a two-point calibration with pH 7 and pH 4 buffers is appropriate. Three point calibration with an additional pH 10 buffer will not increase the accuracy of this measurement since the pH is not within this higher range.

To begin the calibration, immerse the sonde in one of the buffers and enter the actual pH value. Press **Enter**, and the screen will display real-time readings that will allow you to determine when the pH sensor has stabilized. Pressing **Enter** will confirm the calibration. Following the instructions on the screen, place the sonde in the second pH buffer, input the pH value, press **Enter**, and view the stabilization of the values on the screen in real time. After the readings have stabilized, press **Enter** to confirm the calibration. Then, as instructed, press **Enter** again to return to the Calibrate menu.

Select the **3-point** option to calibrate the pH probe using three calibration solutions. In this procedure, the pH sensor is calibrated with a pH 7 buffer and two additional buffers. The 3-point calibration method assures maximum accuracy when the pH of the media to be monitored cannot be anticipated. The procedure for this calibration is the same as for a 2-point calibration, but the software will prompt you to select a third pH buffer to complete the 3-point procedure.

ORP

Select **5-ISE2 ORP** to calibrate the ORP sensor. Immerse the sonde in a solution with a known oxidation reduction potential value (we recommend Zobell solution) and press **Enter**. You will be prompted to enter the ORP value of the solution. Press **Enter**, and monitor the stabilization of the ORP and temperature readings. After no changes occur for approximately 30 seconds, press **Enter** to confirm the calibration. Then, as instructed, press **Enter** again to return to the Calibrate menu.

The following calibrations are for the 6920DW sonde only. If you do not have this sonde, skip to Section 2.9.6, Report.

AMMONIUM

When selecting **6-ISE3-NH₄⁺**, you will be given the choice of 1-point, 2-point, or 3-point calibrations for your ammonium (NH₄⁺) sensor.

Select the **1-point** option only if you are adjusting a previous calibration. If a 2-point or 3-point calibration has been performed previously, you can adjust the calibration by doing a one point calibration. Immerse the sonde in any solution of known ammonium concentration and press **Enter**. You will be prompted to type in the NH₄⁺ value (in mg/L of NH₄-N) of the solution you are using. Press **Enter** again, and the screen will display real-time readings that will allow you to determine when the NH₄⁺ readings have stabilized. Pressing **Enter** will confirm the calibration.

Select the **2-point** option to calibrate the NH₄⁺ probe using only two calibration standards that are both at approximately the temperature of your environmental sample. In this procedure, the NH₄⁺ sensor is usually

calibrated using solutions that contain 1 and 100 mg/L of $\text{NH}_4\text{-N}$. Be certain that the calibration solution and sensor are thermally equilibrated prior to entering NH_4^+ values.

To begin the calibration immerse the sonde in the 1 mg/L standard, press **Enter**, input the $\text{NH}_4\text{-N}$ value, and again press **Enter**. The screen will display real-time readings that will allow you to determine when the sensor has stabilized. Pressing **Enter** will confirm the first calibration. Following the instructions on the screen, place the sonde in the second NH_4^+ standard, press **Enter**, input the correct concentration value, again press **Enter**, and view the stabilization of the values on the screen in real time. After the readings have stabilized, press **Enter** to confirm the calibration. Then, as instructed, press any key to return to the Calibrate menu.

Select the **3-point** option to calibrate the NH_4^+ probe using three calibration solutions, two at ambient temperature and one at a temperature significantly different from ambient. The 3-point calibration method should be used to assure maximum accuracy when the temperature of the media to be monitored cannot be anticipated. The procedure for this calibration is the same as for a 2-point calibration, but the software will prompt you to place the sonde in the additional solution to complete the 3-point procedure. Be certain that the calibration solution and sensor are thermally equilibrated prior to proceeding with the calibration. The recommended order of calibration standards is (1) 100 mg/L standard at ambient temperature, (2) 1 mg/L standard at ambient temperature, and (3) 1 mg/L standard at a different temperature (usually lower) than ambient. For best results, insure a temperature difference of at least 10 C° between the two 1 mg/L standards.

NOTE: YSI strongly recommends the use of the 3-point protocol to ensure the best possible performance from all ISE sensors (ammonium, nitrate, and chloride)

NITRATE

When selecting **7-ISE4 NO3**, you will be given the choice of 1-point, 2-point, or 3-point calibrations for your nitrate (NO_3^-) sensor. The procedure is identical to that for the ammonium sensor, except that the calibrant values are in mg/L of $\text{NO}_3\text{-N}$ instead of $\text{NH}_4\text{-N}$.

NOTE: YSI strongly recommends the use of the 3-point protocol to ensure the best possible performance from all ISE sensors (ammonium, nitrate, and chloride)

CHLORIDE

When selecting **8-ISE5-CL-**, you will be given the choice of 1-point, 2-point, or 3-point calibrations for your chloride (Cl^-) sensor. The procedure is identical to that for the ammonium sensor, except that the calibrant values are in mg/L of Cl instead of $\text{NH}_4\text{-N}$. **IMPORTANT:** We recommend that the user employ standards for chloride that are 10 times greater than for ammonium and nitrate. Thus, the low calibration value should be 10 mg/L and the high calibration value should be 1000 mg/L Cl^- . The difference is due to the fact that the effect of contamination of standards from inadvertent leakage of chloride ion from either the free chlorine probe or the reference junction of the pH probe will be less significant at higher concentrations.

NOTE: YSI strongly recommends the use of the 3-point protocol to ensure the best possible performance from all ISE sensors (ammonium, nitrate, and chloride)

OPTIC TURBIDITY

NOTE: Before calibrating your 6026 or 6136 turbidity sensor, pay particular attention to the following cautions:

- To properly calibrate YSI turbidity sensors, you **MUST** use standards that have been prepared according to details in *Standard Methods for the Treatment of Water and Wastewater (Section 2130 B)*. Acceptable standards include (a) formazin prepared according to *Standard Methods*; (b) dilutions of 4000 NTU formazin concentrate purchased from Hach; (c) Hach StablCal™ standards in various NTU denominations; and (d) AMCO-AEPA standards prepared specifically for the 6026 and 6136 by either YSI or approved vendors who are listed on the YSI website (www.ysi.com). **STANDARDS FROM OTHER VENDORS ARE NOT APPROVED FOR THE YSI TURBIDITY SYSTEM AND THEIR USE WILL LIKELY RESULT IN BOTH CALIBRATION ERRORS AND INCORRECT FIELD READINGS.**
- For AMCO-AEPA standards, the value entered by the user during the calibration protocol is DIFFERENT depending on which sensor (6026 or 6136) is being calibrated. This reflects the empirically determined fact that 6026 and 6136 sensors that have been calibrated to the same value in the primary standard formazin, will have different responses in suspensions of the AEPA-AMCO beads. This effect is likely due to the larger optical cell volume of the 6136. Thus, for example, the label of the YSI 6073 turbidity standard bottle indicates that the value of the standard is **100 NTU when used for calibration of the 6026 sensor, but 123 NTU when used to calibrate the 6136.** Note that the phenomenon of a sensor-specific formazin/AEPA-AMCO ratio is well known for sensors other than the 6026 and 6136.
- The details below are relevant to the calibration of both turbidity sensors offered by YSI – 6026 and 6136. However, to calibrate a 6136 sensor, you should have Version 2.16 or later installed in your sonde.
- If you are calibrating a 6136 turbidity sensor you **MUST** use either a black bottomed calibration cup arrangement or laboratory glassware with the probe guard installed for the calibration. See section 2.6.1 above for details. Failure to carry out the calibration properly can result in inaccurate readings, particularly water of very low turbidity.
- Before proceeding with the calibration, be certain that the probe compartment of the sonde has been cleaned and is free of debris. Solid particles from this source, particularly those carried over from past deployments, will contaminate the standards during your calibration protocol and cause either calibration errors and/or inaccurate field data.

When selecting **Optic T (or OpticC)-6026-Turbidity (or 6136-Turbidity)**, there will be a choice of 1-point, 2-point, or 3-point calibrations for your turbidity sensor.

The **1-point** option is normally used to zero the turbidity probe in 0 NTU standard. Place the sonde in clear water (deionized or distilled) with no suspended solids, and input 0 NTU at the screen prompt. Press **Enter** and the screen will display real-time readings that will allow you to determine when the turbidity readings have stabilized. Press **Enter** after the readings have stabilized to confirm the calibration and zero the sensor. Then, as instructed, press any key to return to the Calibrate menu.

Select the **2-point** option to calibrate the turbidity probe using only two calibration standards. In this case, one of the standards must be clear water (0 NTU) and the other should be in the range of known turbidity for the water to be monitored. For example, if the water to be evaluated is known to be low in turbidity, an appropriate choice of standards might be 0 and 10 NTU. However, for general purpose measurements an appropriate choice of standards is usually 0 and 100 NTU.

To begin the calibration, immerse the sonde in the 0 NTU standard, as instructed, and press **Enter**. It is mandatory that the 0 NTU standard be calibrated first. The screen will display real-time readings that will allow you to determine when the readings have stabilized. Pressing **Enter** will confirm the first calibration.

Following the instructions on the screen, place the sonde in the second turbidity standard, input the correct turbidity value in NTU, press **Enter**, and view the stabilization of the values on the screen in real-time. After the readings have stabilized, press **Enter** to confirm the calibration. Then, as instructed, press any key to return to the Calibrate menu.

Select the **3-point** option for maximum accuracy over the entire range of 0 to 1000 NTU. As for the 2-point procedure, one of the standards must be 0 NTU. Because of the linearity characteristics of the sensors, we recommend that the other two standards have turbidity values of 100 and 1000 NTU. However, the user can select any values that are deemed appropriate. The procedure for this calibration is the same as for a 2-point calibration, but the software will prompt you to place the sonde in the additional solution to complete the 3-point procedure.

For all turbidity calibration procedures, be certain that the standard and sensor are thermally equilibrated prior to proceeding with the calibration.

For further information related to setting up, calibrating and running turbidity measurements, refer to **Section 5.11**.

OPTIC CHLOROPHYLL

When selecting **10-Optic Chlorophyll**, there will be a choice of zeroing the full scale range of the fluorescence sensor (**Fluor Zero**), or calibrating with actual chlorophyll standards (**µg/L 1-point, 2-point, or 3-point**).

If you have selected **Fluor %FS** as a parameter in Report Setup, the sonde will report only relative values of fluorescence in the sample being measured. These values could then be converted into actual chlorophyll concentrations in µg/L by using a post-calibration procedure, after the chlorophyll content of grab-samples taken during a sampling or monitoring study has been analyzed in a laboratory. This determination can involve conducting the extractive analysis procedure described for chlorophyll in *Methods for the Examination of Water and Wastewater* or by carrying out an *in situ* measurement of chlorophyll using a commercial benchtop fluorometer.

The **Fluor zero** option is used to zero the fluorescence probe in a medium that is chlorophyll-free. Place the sonde in clear water, and input 0 at the screen prompt. Press **Enter** and the screen will display real-time readings that will allow you to determine when the fluorescence readings have stabilized. Press **Enter** after the readings have stabilized to confirm the calibration and zero the sensor. Then, press any key to return to the Calibrate menu.

If you select **Chl µg/L** in the initial calibration routine, there will be a choice of 1-point, 2-point, or 3-point options. The 1-point selection is normally used to zero the fluorescence probe in a medium that is chlorophyll-free. If you use this method, you will either choose to utilize the default sensitivity for chlorophyll in the sonde software or to update a previous multipoint calibration. Usually you will place the sonde in clear water, and input 0 µg/L at the screen prompt. After pressing **Enter** the screen will display real-time readings allowing you to determine when the chlorophyll readings have stabilized. Press **Enter** after the readings have stabilized to confirm the calibration and zero the sensor. Then, as instructed, press any key to return to the Calibrate menu.

Note: For the 2-point and 3-point calibrations described below, standards of known fluorescence are required. Two general types of standards can be used: (a) phytoplankton suspensions of known chlorophyll content, and (b) dye solutions whose fluorescence can be correlated to that of chlorophyll. The user is responsible for determining the chlorophyll content of phytoplankton suspensions, either by employing the extractive analysis procedure described in *Standard Methods for the Examination of Water and Wastewater*, or by analyzing the suspension *in situ* using a laboratory fluorometer. See Section 5, **Principles of Operation** of this manual for more information about chlorophyll standards.

Select the **2-point** option to calibrate the chlorophyll probe using only two calibration standards. In this case, one of the standards must be clear water (0 µg/L) and the other should be in the range of a known chlorophyll content of the water to be monitored. For example, if the water to be evaluated is known to be low in chlorophyll, an appropriate choice of standards might be 0 and 10 µg/L. However, for general-purpose measurements an appropriate choice of standards is usually approximately 100 µg/L.

To begin the calibration, immerse the sonde in the 0 µg/L standard, as instructed, and press **Enter**. It is mandatory that the 0µg/L standard be calibrated first. The screen will display real-time readings that will allow you to determine when the readings have stabilized. Pressing **Enter** will confirm the first calibration. Following the instructions on the screen, place the sonde in the second chlorophyll standard, input the correct value in µg/L, press **Enter**, and view the stabilization of the values on the screen in real-time. After the readings have stabilized, press **Enter** to confirm the calibration. Then, as instructed, press any key to return to the Calibrate menu.

Select the **3-point** option for maximum accuracy over the entire range of 0 to 400 µg/L. As with the 2-point procedure, one of the standards must be 0 µg/L. The user can select any values for the second and third standards that are deemed appropriate. The procedure for this calibration is the same as for a 2-point calibration, but the software will prompt you to place the sonde in the additional solution to complete the 3-point procedure.

For all chlorophyll calibration procedures, be certain that the standard and sensor are thermally equilibrated prior to proceeding with the calibration

CAUTION: To be assured of the accuracy for field measurements made with your chlorophyll sensor, you must either initially calibrate the sensor using a phytoplankton suspension of known chlorophyll content or post calibrate you sensor in a spreadsheet by comparing the fluorescence values obtained in field studies with those obtained by laboratory analysis for chlorophyll on grab samples collected during the field study. The use of chemical dye standards for “calibration” of the sensor may not result in accurate correlation between fluorescence and actual chlorophyll readings and is designed primarily to evaluate the sensor for drift. See **Section 5. Principles of Operation** for more information on the proper calibration of your chlorophyll sensor.

OPTIC RHODAMINE WT

When selecting **Rhodamine**, there will be a choice of 1-point, 2-point, or 3-point calibrations for your rhodamine WT sensor.

The **1-point** option is normally used to zero the rhodamine probe in 0 ug/L standard. Place the sonde in clear water with no suspended solids, and input 0 ug/L at the screen prompt. Press **Enter** and the screen will display real-time readings that will allow you to determine when the rhodamine readings have stabilized. Press **Enter** after the readings have stabilized to confirm the calibration and zero the sensor. Then, as instructed, press any key to return to the Calibrate menu.

Select the **2-point** option to calibrate the rhodamine probe using only two calibration standards. In this case, one of the standards must be clear water (0 ug/L) and the other should be in the range of the predicted rhodamine concentration projected for the study. For general purpose measurements an appropriate choice of standards is usually 0 and 100 ug/L.

To begin the calibration, immerse the sonde in the 0 ug/L standard, as instructed, and press **Enter**. It is mandatory that the 0ug/L standard be calibrated first. The screen will display real-time readings that will allow you to determine when the readings have stabilized. Pressing **Enter** will confirm the first calibration. Following the instructions on the screen, place the sonde in the second rhodamine standard, input the correct rhodamine value in ug/L, press **Enter**, and view the stabilization of the values on the screen in real-

time. After the readings have stabilized, press **Enter** to confirm the calibration. Then, as instructed, press any key to return to the Calibrate menu.

Select the **3-point** option for maximum accuracy over the entire range of 0 to 200 ug/L. As for the 2-point procedure, one of the standards must be 0 NTU. The procedure for this calibration is the same as for a 2-point calibration, but the software will prompt you to place the sonde in the additional solution to complete the 3-point procedure.

For all rhodamine calibration procedures, be certain that the standard and sensor are thermally equilibrated prior to proceeding with the calibration.

REESTABLISHING DEFAULT CALIBRATION – “UNCAL” COMMAND

If, for any reason, you want to return to the factory default settings (slope and offset) for any parameter, follow the instructions below:

- Activate any calibration screen (1-point, 2-point, or 3-point) where a numerical entry is requested. In the example below, a 2-point turbidity calibration was selected.
- Instead of entering a numeric value, type the word “uncal” and press **Enter**.
- An “uncal” entry at any calibration prompt will reset both slope and offset for this parameter to the factory default settings.

```
-----Turbidity calibration--
-----
1-1 point
2-2 point
3-3 point

Select option (0 for previous
menu): 2
Enter 1st Turbid NTU:uncal
```

NOTE: When using the 650 MDS as the sonde interface device, the “uncal” operation is performed by holding the **Escape** key down and then pressing the **Enter** key. See **Section 3** of this manual for more details.

CALIBRATION RECORD – THE GLP FILE

When any sensor is calibrated, most 6-series sondes will automatically create a file in sonde memory that provides details of the calibration coefficients before and after the calibration. The file will have a .glp extension and will have the Circuit Board Serial # as the default filename. The file can be viewed by following the path File|Directory|File Details|View from the Main sonde menu.

```
-----File-----
1-Directory      4-View file
2-Upload        5-Quick view file
3-Quick Upload  6-Delete all files

Select option (0 for previous menu): 1
```

Filename	Samples
1-BRIDGE1.dat	19
2-BRIDGE2.dat	27
3-UPLAKE.dat	33
4-CLRLAKE2.dat	167
5-DWNLAKE2.dat	31
6-00003001.glp	39

```
-----File details-----
1-View file
2-File:00003001.glp
3-Samples:    39
4-Bytes:     790
```

Pressing 1-View file will show the calibration record for the sonde. An example is shown below:

m/d/y	hh:mm:ss	S/N	Type	Value
08/23/2001	17:07:50	00003001	Conductivity gain	1.000000
08/23/2001	17:07:50	00003001	Cl2 gain	1.000000
08/23/2001	17:07:50	00003001	pH gain (pH-7)*K/mV	-5.05833
08/23/2001	17:07:50	00003001	pH offset (pH-7)*K	0.000000
08/23/2001	17:07:50	00003001	ORP offset mV	0.000000
08/23/2001	17:07:50	00003001	TDS constant	0.650000
08/23/2001	17:07:50	00003001	Turb Offset	0.000000
08/23/2001	17:07:50	00003001	Turb A1	500.0000
08/23/2001	17:07:50	00003001	Turb M1	500.0000
08/23/2001	17:07:50	00003001	Turb A2	1000.000
08/23/2001	17:07:50	00003001	Turb M2	1000.000
08/23/2001	17:07:50	00003001	Chl Offset	0.000000
08/23/2001	17:07:50	00003001	Chl A1	100.0000
08/23/2001	17:07:50	00003001	Chl M1	100.0000
08/23/2001	17:07:50	00003001	Chl A2	200.0000
08/23/2001	17:07:50	00003001	Chl M2	200.0000
08/23/2001	17:07:50	00003001	Fluor Offset	0.000000
08/23/2001	17:07:50	00003001	Cl2 gain	1.103424

The data in the display shows a new sonde (Circuit Board # 00003001) which has just had its free chlorine sensor calibrated. Note that the initial values for all parameters are the default settings. Only the last entry (Cl2 gain) has been affected by the calibration of the free chlorine sensor. If the conductivity sensor is now calibrated, the new conductivity gain value is now automatically appended to the record as shown below:

m/d/y	hh:mm:ss	S/N	Type	Value
08/23/2001	17:07:50	00003001	Conductivity gain	1.000000
08/23/2001	17:07:50	00003001	Cl2 gain	1.000000
08/23/2001	17:07:50	00003001	pH gain (pH-7)*K/mV	-5.05833
08/23/2001	17:07:50	00003001	pH offset (pH-7)*K	0.000000
08/23/2001	17:07:50	00003001	ORP offset mV	0.000000
08/23/2001	17:07:50	00003001	TDS constant	0.650000
08/23/2001	17:07:50	00003001	Turb Offset	0.000000
08/23/2001	17:07:50	00003001	Turb A1	500.0000
08/23/2001	17:07:50	00003001	Turb M1	500.0000
08/23/2001	17:07:50	00003001	Turb A2	1000.000
08/23/2001	17:07:50	00003001	Turb M2	1000.000
08/23/2001	17:07:50	00003001	Chl Offset	0.000000
08/23/2001	17:07:50	00003001	Chl A1	100.0000
08/23/2001	17:07:50	00003001	Chl M1	100.0000
08/23/2001	17:07:50	00003001	Chl A2	200.0000
08/23/2001	17:07:50	00003001	Chl M2	200.0000
08/23/2001	17:07:50	00003001	Fluor Offset	0.000000
08/23/2001	17:07:50	00003001	Cl2 gain	1.103424
08/23/2001	17:23:13	00003001	Conductivity gain	0.979114

Note that the default value of the conductivity "Value" is 1.00 in the .glp format shown above. This relative number is equivalent to a real cell constant of 5.00 which is provided in the **Advanced|Cal**

Constants and is described in Section 2.9.8. All other values in the .glp file are equivalent to those shown in the **Advanced|Cal Constants** menu.

CAUTION: Calibration records for all sensors will automatically be stored in the .glp file until the **Delete All Files** command is used from the **File** menu. However, if the Delete command is issued, all files, including the .glp (calibration record) file will be lost. Therefore, it is extremely important to remember to upload the .glp file to a PC or a 650 Display/Logger prior to deleting files from the sonde. See Section 2.9.3 for instructions on the upload and viewing of the .glp file.

2.9.3 FILE

Selections from the File menu allow the user to access data that has been stored in the sonde flash disk memory. Select **3-File** from the Main menu.

```
-----File-----
1-Directory      4-View file
2-Upload        5-Quick view file
3-Quick Upload  6-Delete all files

Select option (0 for previous menu): 1
```

Select **1-Directory** to view all files currently stored in sonde flash disk memory. The screen below shows 5 files of varying sizes. To examine the details of each file, press the associated number (e.g., 4 for CLRLAKE2.dat) and an additional screen will be displayed as shown below that quantifies the time of the deployment, the sample interval, and the site where the sonde was used. In addition, the data in the file can be viewed by using the **1-View file** command

```
Filename      Samples
1-BRIDGE1.dat   19
2-BRIDGE2.dat  27
3-UPLAKE.dat   33
4-CLRLAKE2.dat 167
5-DWNLAKE2.dat 31
6-00003001.glp  3

Select option (0 for previous menu): 4
```

```
-----File details-----
-----
1-View file
2-File:CLRLAKE2.dat
3-Samples:   167
4-Bytes:    4421
5-First:08/23/2001
6-First:08:33:40
7-Last :08/23/2001
8-Last :09:04:20
9-Interval:00:00:10
A-Site:Clear Lake
```

Select **2-Upload** to view file lists in memory (same as shown above) and then upload the data to a PC or to the YSI 650 MDS Display/Logger. The uploaded data can then be processed with YSI EcoWatch for Windows to allow data manipulation and to easily generate reports, plots, and statistics. Three formats for file transfer are available: PC6000, Comma & Quote Delimited, and ASCII text.

- **PC6000** format will transfer the data so that it will be compatible with the EcoWatch for Windows (supplied with your sonde) software package. YSI recommends data transfer in this format since it is significantly more rapid than other transfer options. If this data is required in Comma & Quote Delimited and/or ASCII formats, the user can quickly generate data in these formats using the Export function in EcoWatch for Windows.
- **Comma & Quote Delimited** format is commonly used to generate files that can be imported into spreadsheet software in your PC, where you can perform custom data analysis. A comma is still the delimiter, but the radix is corrected to a period. In most cases you should set the Page Length to 0 before using this type of upload format. See the Windows Help section in EcoWatch for information on setting the page length.
- **ASCII Text** is another alternative to transferring data directly to your computer into spreadsheet or other PC-based software.

Prior to upload, a “Time window” display appears to allow you the option to select portions of the logged data to upload. You may select **1-Proceed** to upload all data logged from the dates and times shown.

```

-----Time window-----
1-Proceed
2-Start date=07/17/96
3-Start time=12:00:00
4-Stop  date=07/31/96
5-Stop  time=12:00:00

Select option (0 for previous menu):

```

Select **1-Proceed**. Choose the appropriate file transfer protocol. A status box will appear in the lower right quadrant of the screen. Verification of a successful transfer is indicated when all of the requested data are transferred.

```

-----File type-----
1-PC6000
2-Comma & ' ' Delimited
3-ASCII Text

Select option (0 for previous menu):

```

Press **0** or **Esc** to return to the File menu.

When you select the **3-Quick Upload** option, the same operation as **2-Upload** is performed, except that only the most recent flash disk file is uploaded and it is uploaded in its entirety. You still must choose the transfer format from the three options provided.

Select **4-View File** to examine the data in any file currently stored in sonde flash disk memory. You will first view the same screen as viewed in the Directory menu. From this menu choose the file of interest, then, using the Time window menu, choose the dates and/or times of interest. If you choose dates or times that are not within the designated start and stop times, no data will be displayed.

You may choose the entire file. Use the **Space Bar** to alternately stop and to resume scrolling. Use the **Esc** key to cancel the view.

Select the **5-Quick View File** option to view the last page of data from the last data file in sonde memory. This feature is particularly useful in quickly reviewing recently acquired data at field sites so that system performance can be assessed.

Select **6-Delete all files** to IRREVERSIBLY remove all files from the sonde memory (INCLUDING the .glp file that may contain valuable calibration data). It is critical not to use this option until all relevant data from sonde memory has been transferred to your computer via one of the upload options. There is a verification screen that appears, so that pressing the 6 key does not immediately delete all files at this point.

The management of the .glp calibration record file that is automatically stored in sonde memory and is described in Section 2.9.2 above is similar to that for data files. However, there are some differences in the upload procedure of which the user should be aware. When uploading a .glp file there will be a choice of three upload protocols as shown below:

```

-----File type-----
1-Binary
2-Comma & ' ' Delimited
3-ASCII Text

Select option (0 for previous menu):

```

The binary upload choice should **ONLY** be used when uploading the .glp file to a 650 Display/Logger; if the binary protocol is used in a direct upload to PC, a .glp file will indeed be transferred, but it will not be possible to open it using the current YSI software or any other text editor. Thus, during a direct transfer of the .glp file to your PC, either the CDF or ASCII formats should be used. The result will be the conversion of the file with a .glp extension in the sonde to one with a .txt extension which is now stored in the ECOWWIN\DATA subdirectory of your PC. For example, the file 00003001.glp in the sonde will become 00003001.txt on transfer to PC and the file will be in a format which can easily be viewed and edited using Notepad or other word processing software.

2.9.4 STATUS

Select **4-Status** from the Sonde Main menu to obtain general information about the sonde and its setup.

```

-----Status-----
1-Version:1.00
2-Date=07/22/96
3-Time=09:04:28
4-Bat volts: 9.0
5-Bat life 21.2 days
6-Free bytes:129792
7-Logging:Inactive

Select option (0 for previous menu):

```

- Select **1-Version** to identify the specific version of sonde software loaded in the sonde. This number is especially useful if you are calling YSI Customer Service. It may also be useful to you if you are comparing 2 or more sondes purchased at different times.
- Select **2-Date and 3-Time** to display current date and time in 24-hour format. This is not a “live” display, but may be updated by pressing the 2 or 3 key again. This may be useful for viewing or setting real time. You may correct date or time from this submenu, by entering the corrected date or time as described in System setup. However, you cannot alter date format from this screen.
- In options **4, 5, and 6**, you can view battery voltage, battery life, and available free memory in your sonde to help you evaluate whether the current setup is appropriate to complete an active logging or to begin a study in which you have defined your logging parameters. If you press key 4, 5 or 6 before you exit this screen, it may change, since this triggers the Status screen to update information.
- **7-Logging** provides one of two messages, active or inactive, indicating whether your sonde is in the unattended logging mode. This logging status indicator is not relevant to logging in the discrete mode, since there is no way to enter the Status screen without stopping discrete logging.

Press **0** or **Esc** to exit the Status screen and return to Main menu.

2.9.5 SYSTEM

Select **5-System** from the Sonde Main menu to set the date and time, customize the sonde communication protocol, adjust how information appears on the screen, and enter an instrument identification number and a GLP file designation.

```

1-Date & time
2-Comm setup
3-Page length=25
4-Instrument ID=YSI Sonde
5-Circuit board SN:00003001
6-GLP filename=00003001
7-SDI-12 address=0
8-(*)English
9-( )Fran?ais
A-( )Deutsch

Select option (0 for previous menu):

```

Select **Date & time**.

```

-----Date & time setup-----
1-(*)m/d/y          4-( )4 digit year
2-( )d/m/y          5-Date=08/11/98
3-( )y/m/d          6-Time=11:12:30

Select option (0 for previous menu):

```

Press **4** and **5** to activate the date and time functions. Pay particular attention to the date format that you have chosen when entering date. Use the 24-hour clock format for entering time. Option **4- () 4 digit** year may be chosen to have the date appear with a two or four digit year.

Press **0** or **Esc** to return the System Setup menu.

Select **2-Comm setup** From the System Setup menu.

```

-----Comm setup-----
1-(*)Auto baud      5-( )2400 baud
2-( )300 baud       6-( )4800 baud
3-( )600 baud       7-(*)9600 baud
4-( )1200 baud

Select option (0 for previous menu): 0

```

The default is 9600, but you may change it to match your host communication interface protocol by typing in the corresponding number, 1 through 7. An asterisk confirms the selection. Auto baud may be selected along with any of the choices. The Auto baud option allows the sonde to recognize and adjust to the received characters and we recommend that it is activated.

NOTE: If you change the baud rate, exit the sonde interaction and immediately change the baud rate in EcoWatch for Windows, Comm Settings. If you do not adjust the baud rate in the PC software, the sonde will not be able to communicate with the computer or any display/logger and your system will appear to be "locked-up."

Select **3-Page length** from the System Setup menu and press **Enter**. This will allow you to control how many lines of data are sent to your display before a new header is shown. The smaller the page number, the fewer the lines of data will be transmitted to your display between headers. However, if you set the page length to zero (0), only the initial header will be displayed. In many cases, a page length of zero is the preferred configuration if you choose to upload your data in an ASCII or CDF format. See **Section 2.9.3, File Menu**, for more details.

NOTE: The header itself takes 4 lines. Therefore, if the page length is set to 25, there will be 21 lines of data and one header. Any page length less than 5 will result in no header being transmitted.

Select **4-Instrument ID** from the System setup menu to record the instrument ID number (usually the instrument serial number), and press **Enter**. A prompt will appear which will allow you to type in the serial number of your sonde. This will make sure that any data that is collected is associated with a particular sonde.

The **5-Circuit Board SN** entry shows the serial number of the PCB that is resident in your sonde (not the entire system as for Instrument ID). Unlike the **Instrument ID**, the user cannot change the **Circuit Board SN**.

Select **6-GLP filename** to enter a name for the file that is automatically generated and appended as you calibrate any of the sonde sensors. The default designation for the GLP file is the Circuit Board SN and this name can be retained if you wish. See section 2.9.3 for general information on the GLP file.

Select **7-SDI-12 address** from the System Setup menu to change the value. Input a number between 0 and 9 and then press **Enter** to confirm the selection. The SDI-12 default address is zero (0). This feature is fully described in **Section 7, Communication** and only utilized if the unit is to operate in a SDI-12 communication protocol network.

Finally, select your language of choice for the sonde menus. Then press **Esc** or **0** again to return to the Main menu.

2.9.6 REPORT

The Report menu allows you to configure all reports displayed by the sonde software. You will be able to select which parameters and units of measure that are displayed during operation.

Select **6-Report** from the sonde Main menu. The following menu, or a similar menu, will be displayed. The parameters listed depend on both the sensors available and enabled on your sonde. Therefore your screen may not be identical to that shown below.

Select **Report** from the Main sonde menu to setup the report section. The Report Setup menu will be displayed.

```

-----Report setup-----
1-(*)Date           A-( )Cl2 chrg
2-(*)Time hh:mm:ss B-( )pH
3-(*)Temp C         C-( )pH mV
4-(*)SpCond uS/cm  D-(*)Orp mV
5-( )Cond           E-( )PAR1
6-( )Resist         F-( )PAR2
7-( )TDS           G-(*)Turbid NTU
8-( )Sal ppt       H-(*)Chl ug/L
9-(*)Free Cl2      I-( )Fluor %FS

Select option (0 for previous menu):

```

The asterisks (*) that follow the numbers or letters indicate that the parameter will appear on all outputs and reports. To turn a parameter on or off type the number or letter, that corresponds to the parameter, after **Select option**. The parameters “PAR1” and “PAR2” are associated with a special sonde equipped with a sensor for Photosynthetically Active Radiation (PAR) which can be purchased from the YSI Massachusetts, but is not likely to be useful in drinking water studies. See **Section 8** of this manual for contact information if you have questions about this sensor.

Note that the units of turbidity are automatically presented as “turbid NTU” if a 6026 sensor has been selected and “turbid+ NTU” if a 6136 sensor has been selected. The different designations are designed to differentiate the data from the two sensors types in later analysis.

For parameters with multiple unit options such as temperature, conductivity, specific conductance, resistivity and TDS, a submenu will appear as shown below, allowing selection of desired units for this parameter.

```

-----Select units-----
1-(*)NONE
2-( )Temp C
3-( )Temp F
4-( )Temp K

Select option (0 for previous menu): 2

```

After configuring your display with the desired parameters, press **Esc or 0** to return to the Main menu.

Even if all of the sensors are enabled, the measurements for those sensors will not appear on your display unless the parameter is selected in Report setup. In order for a specific parameter to show up on a report:

1. The sensor must first be enabled (turned on).
2. That parameter must be activated in the Report setup.

In the above example, if the appropriate sensors have been activated in the Sensor setup section, the following parameters will be displayed to the computer screen or captured to a computer or data collection platform when the sonde is sampling: Temperature in C, Specific Conductance in uS/cm, Free chlorine in mg/L, pH, ORP in millivolts, Turbidity in NTUs and Chlorophyll in ug/L. Date and time will also be displayed.

NOTE: Do not attempt to memorize or associate a number or letter with a particular parameter. The numbering scheme is dynamic and changes depending on the sensors which have been enabled.

The following list is a complete listing of the abbreviations utilized for the various parameters and units available in the Report setup menu.

Parameter	Description
Date	Day/Month/Year (format selectable)
Time	Hour:Minute:Second (24-hour clock format)
Temp C	Temperature in degrees Celsius
Temp F	Temperature in degrees Fahrenheit
Temp K	Temperature in degrees Kelvin
SpCond mS/cm	Specific Conductance in milliSiemens per centimeter
SpCond uS/cm	Specific Conductance in microSiemens per centimeter
Cond mS/cm	Conductivity in milliSiemens per centimeter
Cond uS/cm	Conductivity in microSiemens per centimeter
Resist MOhm*cm	Resistivity in MegaOhms * centimeter
Resist Kohm*cm	Resistivity in KiloOhms * centimeter
Resist Ohm*cm	Resistivity in Ohms * centimeter
TDS g/L	Total dissolved solids in grams per liter
TDS kg/L	Total dissolved solids in kilograms per liter
Sal ppt	Salinity in parts per thousand (set to local barometer at calibration)
Free Cl2 mg/L	Free chlorine concentration in mg/L
Cl2 chrg	Free chlorine sensor charge
pH	pH in standard units
pH mV	millivolts associated with the pH reading
Orp mV	Oxidation reduction potential value in millivolts
NH4+ N mg/L	Ammonium Nitrogen in milligrams/liter
NH4+ N mV	Ammonium Nitrogen in millivolt reading
NH3 N mg/L	Ammonia Nitrogen in milligrams/liter
NO3- N mg/L	Nitrate Nitrogen in milligrams/liter
NO3- N mV	Nitrate Nitrogen in millivolt reading
Cl- mg/L	Chloride in milligrams/liter
Cl- mV	Chloride in millivolt reading
Turbid NTU	Turbidity in nephelometric turbidity units from 6026 sensor
Turbid+ NTU	Turbidity in nephelometric turbidity units from 6136 sensor
Chl ug/L	Chlorophyll in micrograms/liter
Fluor %FS	Fluorescence in percent Full Scale
Rhod ug/L	Rhodamine WT in micrograms/liter

2.9.7 SENSOR

The Sensor menu allows you to Enable or Disable (turn on or off) any available sensor and, in some cases, to select the port in which your sensor is installed.

From the Sonde Main menu select **7-Sensor** and the following display will appear.

```

-----Sensors enabled-----
1-(*)Time           7-( )ISE3 NONE
2-(*)Temperature    8-( )ISE4 NONE
3-(*)Conductivity   9-( )ISE5 NONE
4-(*)Free Cl2       A-( )Optic
5-(*)ISE1 pH        B-( )Battery
6-(*)ISE2 Orp

Select option (0 for previous menu):

```

Note that the exact appearance of this menu will vary depending upon the sensors available on your sonde.

When a particular sensor is active, an asterisk will appear in the parentheses associated with the selection. In this example the time, temperature, conductivity, free chlorine, pH, ORP, and battery sensors are enabled. To disable a sensor, simply press the number of the active sensor or port, and the asterisk will disappear.

For the ISE and Optic selections, press the appropriate number, and then enable or disable the sensor using the submenu choices. Be certain that the appropriate sensor is “enabled” in the submenu according to the sonde bulkhead port in which it is physically installed. For example, if an ammonium sensor is placed in the port labeled “3” on the bulkhead, enable the sensor as ISE3 in the menu structure.

The following screen is the submenu selection structure for ISE3, ISE4 and ISE5.

```

-----Select type-----
1-( ) ISE3 NH4+
2-( ) ISE3 NO3-
3-( ) ISE3 Cl-
4-( ) ISE3 PAR1

Select option (0 for previous menu):

```

As noted above, the ISE3 PAR1 selection is used in a special instrument mated to a sensor for Photosynthetically Active Radiation that is available from YSI Massachusetts but is not likely to be useful in drinking water studies. See **Section 8** for contact information if you have questions about this sensor.

A submenu similar to that below will appear if either “Optic T” or “Optic C” is chosen as a sensor.

```

-----Select type-----
1-(*)Optic-T(or C) Turbidity-6026
2-( )Optic-T(or C) Turbidity-6136
2-( )Optic-T(or C) Chlorophyll
3-( )Optic-T(or C) Rhodamine

Select option (0 for previous menu):

```

Any available optical probe can be installed in any optical port on YSI 6-series sondes. The single optical port in the 6920DW will be designated “Optic T” in the software even though the port is not physically labeled with a “T” on the bulkhead.

2.9.8 ADVANCED

From the Sonde Main menu select **8-Advanced** to display the sensor calibration constants, additional setup options, sensor coefficients and constants, and digital filtering options. The parameters listed depend on both the sensors installed and the sensors enabled, therefore your screen may not be identical to those shown below.

```

-----Advanced-----
1-Cal constants
2-Setup
3-Sensor
4-Data filter

Select option (0 for previous menu): 1

```

Select **1-Cal constants** to display the calibration constants, as shown in the following example. Note that values only appear for the enabled sensors.

```

-----Cal constants-----
1-Cond:5                B-NO3 A:2.543
2-Cl2 gain:1.3048      C-Cl J:99.5
3-mV offset:0         D-Cl S:-0.195
4-pH offset:0         E-Cl A:2.543
5-pH gain:-5.05833    F-Turb Offset:0
6-NH4 J:51.2          G-Turb A1:500
7-NH4 S:0.195         H-Turb M1:500
8-NH4 A:1.092         I-Turb A2:1000
9-NO3 J:99.5          J-Turb M2:1000
A-NO3 S:-0.195

Select option (0 for previous menu): 0

```

The following table provides the default value, operating range, and comments relative to the calibration constants. Error messages will appear during calibration if values are outside the indicated operating range unless the designation is “not checked”.

<i>Parameter</i>	<i>Default</i>	<i>Operating range</i>	<i>Comments</i>
Cond:	5	4 to 6	Traditional cell constant
Cl2 gain:	1	0.5 to 2.0	
mV offset:	0.0	-100 to 100	
pH offset:	0.0	-400 to 400	
pH gain:	-5.0583	-6.07 to -4.22	
NH4 J	51.2	Not checked	
NH4 S	0.195	0.15 to 0.217	
NH4 A	1.092	Not checked	
NO3 J	99.5	Not checked	
NO3 S	-0.195	-0.217 to -0.15	
NO3 A	2.543	Not checked	
Cl J	99.5	Not checked	
Cl S	-0.195	-0.217 to -0.15	
Cl A	2.543	Not checked	
Turb Offset	0	-10 to 10	
Turb A1	500	0.6 to 1.5	Range is ratio of M1 to A1
Turb M1	500		
Turb A2	1000	0.6 to 1.5	Range is ratio of (M2-M1) to (A2-A1)
Turb M2	1000		
Chl Offset	0	-30 to 20	
Chl A1	500	0.6 to 1.5	Range is ratio of M1 to A1
Chl M1	500		
Chl A2	1000	0.6 to 1.5	Range is ratio of (M2-M1) to (A2-A1)
Chl M2	1000		
Rhod Offset	0	-10 to 10	
Rhod A1	500	0.6 to 1.5	Range ratio of M1 to A1
Rhod M1	500		
Rhod A2	1000	0.6 to 1.5	Range is ratio of (M2-M1) to (A2-A1)
Rhod M2	1000		

To reset a calibration cell constant, access the sonde Calibrate menu. Then select the sensor and type “UNCAL” instead of the value. This action will change that sensors calibration constants back to the factory default.

From the Advanced menu, select **2-Setup** to display miscellaneous options. Type the appropriate number to activate/deactivate any of the displayed features.

```

-----Advanced setup-----
1-(*)VT100 emulation
2-( )Power up to Menu
3-( )Power up to Run
4-( )Comma radix
5-(*)Auto sleep RS232
6-( )Auto sleep SDI12
7-( )Multi SDI12
8-( )Full SDI12
9-( )Sample and Hold

Select option (0 for previous menu): 0

```

1-(*)VT100 emulation. Activate this option for VT100 terminal emulation. This feature allows the sonde to send escape sequences to clear the screen which in turn results in an improved display. Usually this feature should be activated, but, if your terminal or terminal emulator shows odd characters at the beginning of each menu title, then turn this item off. With the feature off, the sonde will send several carriage returns and line feeds to 'clear' the display. The number of <cr>'s and <lf>'s is determined by the page length setting.

2-()Power up to Menu. When this item is enabled, the sonde will go directly to menu mode when power is applied to the sonde. If the command line mode is not useful for your applications, then enabling this item will negate the need to type "Menu" and **Enter** at the # prompt to access the Main sonde menu. Activation of this item is NOT recommended except for special applications.

3-()Power up to Run. When this item is enabled the sonde will start sampling and output data as soon as power is applied to the sonde. If "Power up to menu" is also enabled, the sonde will first enter the menu mode and then the run mode where it will start sampling. If "Power up to menu" is not enabled, the sonde will go to command line mode and then start the run function. With "Power up to Run" disabled, the sonde will wait for your command at power up (in either command line or menu mode) as set by "Power up to Menu". If you are using your sonde for Unattended sampling, do not activate this mode. Activation of this item is NOT recommended except for special applications.

4-()Comma radix. When this item is enabled, the sonde will replace decimal points with commas when printing numbers. NOTE: Regardless of this setting, SDI-12 'D' commands will still respond using a decimal point.

5-(*)Auto sleep RS232. Activation of this feature enables a power savings system when communicating with the sonde in RS-232 mode. When enabled, power is only applied to the sensors during sampling or calibration. The most important aspect of this feature is its effect on the free chlorine protocol as described in Section 2.9.2. For this reason, this feature should be activated for long term monitoring studies in the RS-232 communication mode and deactivated for sampling studies where the user is present and the sonde runs continuously. Even with Autosleep inactive, the sonde will "sleep" after one minute with no communications.

6-(*)Auto sleep SDI12. Activation of this feature enables the power savings system when communicating with the sonde in SDI-12 mode. This is basically the same as item 5 above except that it is used in communication via the SDI-12 interface. Also, the sonde will "sleep" in about 100 milliseconds in the absence of communication, rather than waiting one minute in the Auto sleep RS-232 mode.

7-() Multi SDI12. Modifies the SDI12 protocol as follows: (1) No SDI12 service request will be issued. (2) Break commands will not cause a measurement reading to be aborted. Normally, you should leave this feature “off”.

8-() Full SDI12. Enabling this feature forces full SDI-12 specification in order to pass the NR Systems SDI-12 Verifier. Disabling this feature will allow the unit to be more fault tolerant and will save some power. We recommend that you leave this feature “off”.

9-() Sample and Hold. This feature is designed to be activated ONLY for studies in which your drinking water sonde is attached to a YSI Process Monitor. When “Sample and Hold” is active, the 6500 display and the SCADA output of the 6500 becomes equivalent to the internal memory of the sonde while an Unattended study is running. In the Unattended mode, the sonde “sleeps” between periodic samples with the interval between samples defined by the user. This method of operation results the extension of both the sonde battery life (not important in 6500 applications) and the time between required sensor maintenance procedures (which is important to 6500 drinking water applications). After activation of the feature another entry will appear automatically which will allow you to input your sample interval which defines how often data is transmitted to the 6500 display. This new sample interval will automatically become the sample interval for the **Run|Discrete sample** mode of operation and you will not be able to change the interval until **Sample and Hold** is deactivated. In addition, the interval in the Run|Unattended **sample** mode will also change to the Sample and Hold interval. In this case, however, you will be able to change the Unattended Sample interval, but with the caveat that the **Sample and Hold interval** will also change, i.e., the **Unattended sample interval** and the Sample and Hold interval MUST be synchronized and the software assures that this will be the case.

REMEMBER: DO NOT ACTIVATE THIS FEATURE UNLESS (A) YOUR SONDE IS ATTACHED TO A 6500 AND (B) YOU HAVE READ THE DETAILED DESCRIPTION OF THE FEATURE IN APPENDIX G. USING YOUR DRINKING WATER SONDE WITH A 6500 PROCESS MONITOR.

Select **3-Sensor** to display and change user-configurable constants as shown in the following display. Type the appropriate number to change to these parameters.

```

-----Advanced sensor-----
1-TDS constant=0.65
2-Cl2 temp co %/C=2.5
7-Cl2 warm up sec=60
8-(*)Wait for Cl2
9-Wipes=1
A-Wipe int=1
B-SDI12-M/wipe=1
C-Turb temp co %/C=0.3
D-(*)Turb spike filter
E-Chl temp co %/C=0

Select option (0 for previous menu):

```

NOTE: The number of items on this menu depends greatly on the sensors that are available and enabled on your sonde. Below we describe every possible item on this menu. Your sonde probably may not have every item described below.

To edit one of the following menu items choose the number or letter that corresponds to it.

- TDS constant=0.65** This selection allows you to set the constant used to calculate TDS. TDS in g/L is calculated by multiplying this constant times the specific conductance in mS/cm. This item will only appear if the conductivity sensor is enabled in the “Sensors enabled” menu. See Section 5, Principles of Operation for more information on the TDS parameter.
- Cl2 temp co=2.5 %/C** This selection allows you to input the free chlorine temperature coefficient. Do not change this value unless you consult YSI Customer Service. *This item will only appear if the free chlorine sensor is enabled in the Sensors menu.*
- Cl2 warm up=60** This selection allows you to set the amount of time allowed for Cl2 warm up in seconds. Normally the default value of 60 seconds is adequate for most applications. However, there may be certain situations in which greater free chlorine accuracy can be attained by increasing this time. Consult YSI Customer Service if you feel that your Cl2 warm up time is incorrect. *This item will only appear if the free chlorine sensor is enabled in the Sensors menu.*
- (*)Wait for Cl2** When this feature is enabled, the sonde is forced to wait for the Cl2 warm up time to expire before displaying any readings. Note that in SDI12 mode or while calibrating the Cl2 sensor, the warm up time is used regardless of the activation of this item. Disabling this item allows you to see data without having to wait during the Cl2 warm up time. **Under normal operating conditions, this item should be turned off.** If you are using the sonde with a data logger in RS232 mode and will be turning the sonde “on” and “off” for each sample, then you may want to enable this item so that only stable Cl2 data are recorded. *This item will only appear if the Cl2 sensor is enabled in the Sensors menu.*
- Wipes=1** If a turbidity, chlorophyll, or rhodamine WT sensor is enabled, this selection will determine the number of cleaning cycles which will occur when the wiper is activated manually or automatically. Since the wiper functions bidirectionally, a selection of “1” results in two passes of the wiper over the optical face. In most applications, a single cleaning cycle is adequate to keep the optical surface free of bubbles and fouling. However, in particularly harsh environments additional cleaning cycles may be needed and can be selected here. *This item will only appear if a turbidity, chlorophyll, or rhodamine WT sensor is enabled in the Sensors menu.*
- Wipe Int=1** In applications where a turbidity, chlorophyll, or rhodamine WT probe is installed in the sonde and the instrument is collecting data in the SDI-12 communication mode, the wiper mechanism of the probe should be activated automatically in a periodic manner to clean the optical surface for fouling and bubbles. The value entered at this selection is the number of minutes between each automatic cleaning cycle. Thus, if Wipe Int is set to “5” and the instrument is in the Run mode, the wiper will activate every 5 minutes with no manual input. *This item will only appear if a turbidity, chlorophyll, or rhodamine WT sensor is enabled in the Sensors menu.*
- The value of Wipe Int is sometimes overridden when the instrument is set up in the Unattended sampling mode. Under these conditions, the wiper will be automatically activated at the interval assigned in the Unattended setup rather than that assigned in Wipe Int. Thus, in an Unattended study setup at a 15 minute sampling interval, the wiper will be activated only once every 15 minutes rather than at the indicated Wipe Int of 1 minute.

CAUTION: If Wipe Int is set to zero, then no wiping will occur either in Discrete or Unattended Sampling. Make certain that Wipe Int is set to some finite value prior to setting up an Unattended study or no automatic cleaning will occur.

SDI12-M/Wipe=1 This is the number of wiping cycles when the sonde is in SDI12 mode. The wiper for the 6026 and 6136 turbidity, 6025 chlorophyll, and 6130 rhodamine WT sensors will automatically wipe each time this many SDI12 “M” commands have been issued. If this value is set to zero, then no automatic wiping will occur. *This item will only appear if a turbidity, chlorophyll, or rhodamine WT sensor is enabled in the Sensors menu.*

Turb temp co %/C=0.3 This entry sets the coefficient for the temperature compensation of turbidity readings from the 6026 and 6136 sensors. The default values of 0.3 (6026) and 0.6 (6136) should not be changed by the user without consulting YSI Customer Service. *This item will only appear if a turbidity sensor is enabled in the Sensor menu.*

(*) **Turb Spike Filter** When this item is activated, the output of the turbidity sensor is mathematically processed to minimize the effect of unusual (or “bad”) readings on the overall data presentation. In most cases, these “spike” events are the result of the chance passage of large suspended particles across the probe optics just at the time a reading is taken. Activation of this option generally results in a better display of the “average” turbidity of the water under examination and its use is recommended for most sampling and unattended applications. *This item will only appear if a turbidity sensor is enabled in the Sensors menu.*

Chl temp co %/C=0.0 This entry sets the coefficient for the temperature compensation of chlorophyll readings from the 6025 sensor. The default value of zero should only be changed by the user after establishing the temperature compensation factor for the phytoplankton sample in question. See Section 5.12 of this manual for more information. *This item will only appear if a chlorophyll sensor is enabled in the Sensors menu.*

From the Advanced menu, select **4-Data filter** to display filtering options. Type the appropriate number to activate/deactivate any of the displayed features.

Sondes with **no optical (turbidity, chlorophyll, or rhodamine WT) probes** enabled will display the following menu.

```

-----Data filter setup-----
1-(*)Enabled
2-( )Wait for filter
3-Time constant=4
4-Threshold=0.001

Select option (0 for previous menu):

```

If any optical probe (turbidity, chlorophyll, or rhodamine WT) **is enabled**, then the menu will appear as follows.

```

-----Data filter setup-----
1-(*)Enabled
2-( )Wait for filter
3-Time constant. . .
4-Threshold. . .

Select option (0 for previous menu):

```

Choosing 3-Time Constant will display the following:

```

-----Time constant -----
1- Turbid=12
2- Chl=12
3- Other=4

Select option (0 for previous menu):

```

Recommended settings for time constants are turbidity 12, rhodamine WT 12, chlorophyll 12, and “other” 4. Note that the time constant can be set independently for turbidity, chlorophyll, and rhodamine WT and that time constant choices are only available for activated sensors. Rhodamine WT would appear in the display below if it had been activated as a sensor. All “other” sensors use the same time constant as shown below.

Choosing **4-Threshold** will display the following:

```

-----Threshold-----
1-Turbid=0.01
2-Chl=1
3-Other=0.001

Select option (0 for previous menu):

```

Setting thresholds is done in the same manner. Recommended threshold settings are 0.01 for turbidity, 1.0 for chlorophyll, 1.0 for rhodamine WT, and 0.001 for “other”.

The following descriptions provide additional information about the Data Filter feature.

1-(*) Enabled. Activating this item will result in data filtering according to the values set in (2), (3), and (4).

2-(*) Wait for filter. If this feature is activated, readings will be available for output only after the unit has warmed up for a time period equal to the Time Constant plus an extra 4 seconds. This feature is useful, for example, if you are operating in SDI12 mode and want to average the data over a particular period of time. In such a case, you would not want the filter to be engaging and disengaging, so the value of the Threshold should be set to a large value like 1. This feature should not be activated for normal use of the sonde.

3-Time Constant. This value is the time constant in seconds for the software data filter. Increasing the time constant will result in greater filtering of the data, but will also slow down the apparent response of the sensors.

4-Threshold. This value determines when the software data filter will engage/disengage. When the difference between two consecutive unfiltered readings is larger than the threshold, then the reading is displayed unfiltered. When the difference between two consecutive readings drops below the threshold, readings will be filtered again. For the purposes of the filter, consecutive readings are never more than 0.5 seconds apart. When sampling faster than 0.5 seconds consecutive readings will be at the faster rate and you may want to adjust the threshold accordingly. See section 2.9.1 for details on fast sampling.

The threshold feature is intended to speed response to large changes in a reading. For example, when changing from pH 7 buffer to a pH 4 buffer in a calibration, it is likely that the filter will disengage for a time showing unfiltered readings until the sensor has nearly equilibrated with the new buffer. At that time, the filter will re-engage and show filtered readings. Without disengaging the filter for awhile, much more time would be required to come to equilibrium after large changes in reading.

During the first time constant after the filter first engages, the output reflects a simple average of all the readings from the time the filter engaged until the present. Once the filter has been engaged for the period of the time constant, it becomes a simple filter with a time constant equal to that set in **3-Time Constant**. Each time the filter disengages and then re-engages, this process is repeated.

Filter engagement and disengagement occurs for each sensor independently. One parameter may be filtered while another is not because readings from one sensor are changing more than another.

Example: Moving a sonde from the air to a river water sample. Assume that the temperature of the sonde is similar to the temperature of the water, and that the water is in equilibrium with the air. The temperature and oxygen readings taken in the water will be very similar to those taken in the air. The conductivity reading in air is near zero, and quite likely, is a very different reading in the water. The filter for the conductivity readings will likely disengage when the sonde is first placed in the river water, but stay engaged for the temperature and free chlorine readings.

The filters for turbidity, chlorophyll, and rhodamine WT are somewhat different. For these sensors, the filter is temporarily disengaged during mechanical wiping so that when wiping is finished, the reading is the most current. The filter then reengages if possible. Optical sensor readings are frozen to the output during wiping so that “bad” values are not output.

A value of 0.001 for the threshold roughly corresponds to the following changes in sensor readings:

Temp: 0.1 °C

Conductivity in the 100 mS/cm range: 0.1 ms/cm

Conductivity in the 10 mS/cm range: 0.01 ms/cm

Conductivity in the 1 mS/cm range: 0.001 ms/cm

Conductivity in the 100 µS/cm range: 0.1 us/cm

Free Chlorine: 0.01 mg/L

pH, ORP, Ammonium, Nitrate and Chloride: 0.6 mV

A value of 0.01 for the threshold roughly corresponds to a 10NTU change in turbidity. A value of 1.0 for the chlorophyll and rhodamine WT sensors threshold effectively means that the filter will be engaged under all conditions.

2.10 CARE, MAINTENANCE AND STORAGE

This section describes the proper procedure for storage of the sensors that will maximize their lifetime and minimize the time required to get the sonde ready for a new application. This section will describe interim or short-term storage between applications where the sonde is being used at a regular interval (daily, weekly, biweekly, etc.) and long term storage, (e.g., over-the-winter), where the sonde will not be used on a regular basis for several months.

In the descriptions and instructions below, it is assumed that the user has retained the vessels (bottles, boots, etc.) in which the individual sensors were stored on initial delivery. If these specific items have been misplaced or lost, they can be replaced by contacting YSI Customer Service. Alternatively, the user may have similar (and equally acceptable) storage equipment on hand even though it was not part of the original YSI package. Common sense should be the guide on substitution of storage vessels.

<p>REMEMBER: DO NOT ATTEMPT TO GAIN ACCESS TO THE INTERNAL CIRCUITRY OF THE SONDE.</p>

2.10.1 SONDE CARE AND MAINTENANCE

The YSI 6570 Maintenance Kit is available for use with your sonde. The kit includes several items that will be helpful or necessary to perform the proper routine maintenance on your sonde.

The 6570 Maintenance Kit includes two types of O-rings (for probes and cable connector), probe/installation/replacement tools, two cleaning brushes for the conductivity sensor, O-ring lubricant, and a syringe for cleaning the depth sensor port.

The 6570 Maintenance Kit can be ordered from any authorized YSI dealer, or directly from YSI. See Appendix C for details.

When caring for your sonde, remember that the sonde is sealed at the factory, and there is never a need to gain access to the interior circuitry of the sonde. In fact if you attempt to disassemble the sonde, you would void the manufacturer's warranty.

O-RING CARE AND MAINTENANCE

Your 6-series sondes utilize user-accessible o-rings as seals to prevent environmental water from entering the battery compartment and the sensor ports. Please read the following instructions carefully prior to deploying your YSI Sonde. Following the recommended procedure will assure that no problems will occur with regard to water influx into your sonde.

If the o-rings and sealing surfaces on the sondes are not maintained properly, it is possible that water can enter the battery compartment and/or sensor ports of your sonde. If water enters these areas, it can severely damage the battery terminals or probe ports causing loss of battery power during a deployment, false readings and corrosion to the probes. Therefore, when the battery compartment lid is removed from 600XLM, 6920, 6600, and 600 OMS (battery version) sondes, the o-rings that provide the seal should be carefully inspected for contamination (e.g. hair, grit, etc.) and cleaned if necessary using the instructions provided below. The same inspection should be made of the o-rings associated with the probes, port plugs, and field cable connectors when they are removed. If no dirt or damage to the o-rings is evident, then they should be lightly greased without removal from their groove. However, if there is any indication at all of damage, the o-ring should be replaced with an identical item from the YSI 6570 Maintenance Kit supplied with your sonde. At the time of o-ring replacement, the entire o-ring assembly should be cleaned as described below.

To remove the o-rings:

Use a small, flat-bladed screwdriver or similar blunt-tipped tool to remove the o-ring from its groove. Check the o-ring and the groove for any excess grease or contamination. If contamination is evident, clean the o-ring and nearby plastic parts with lens cleaning tissue or equivalent lint-free cloth. Alcohol can be used to clean the plastic parts, but use only water and mild detergent on the o-ring itself. Also, inspect the o-rings for nicks and imperfections.

CAUTION:

- Using alcohol on o-rings may cause a loss of elasticity and may promote cracking.
- Do not use a sharp object to remove the o-rings. Damage to the o-ring or the groove itself may result.

Before re-installing the o-rings, make sure that you are using a clean workspace, clean hands and are avoiding contact with anything that may leave fibers on the o-ring or grooves. Even a very small bit of contamination (hair, grit, etc.) may cause a leak.

To re-install the o-rings:

- Place a small amount of Teflon stopcock grease between your thumb and index finger. (More grease is NOT BETTER!)
- Draw the o-ring through the grease while pressing the fingers together. Use this action to place a VERY LIGHT covering of grease to all sides of the o-ring. Place the o-ring into its groove making sure that it does not twist or roll.
- Use the previously grease-coated finger to once again lightly go over the mating surface of the o-ring. DO NOT use excess grease on the o-ring or the o-ring groove.

CAUTION: Do not over-grease the o-rings. The excess grease may collect grit particles that can compromise the seal. Excess grease can also cause the waterproofing capabilities of the o-ring to diminish, potentially causing leaks into the compartment. If excess grease is present, remove it using lens cloth or lint-free cloth.

SONDE PROBE PORTS

Whenever you install, remove or replace a probe, it is extremely important that the entire sonde and all probes be thoroughly dried prior to the removal of a probe or a probe port plug. This will prevent water from entering the port. Once you remove a probe or plug, examine the connector inside the sonde probe port. If any moisture is present, use compressed air to completely dry the connector. If the connector is corroded, return the sonde to your dealer or directly to YSI Customer Service, see **Section 8, Warranty and Service Information**, for details. When you reinstall a probe or port plug, lightly grease the O-ring with lubricant supplied in the YSI 6570 Maintenance Kit.

CABLE CONNECTOR PORT

The cable connector port at the top of the sonde should be covered at all times. While communicating with the sonde, a cable should be installed and tightened in place. This will assure that a proper connection is being made and prevent moisture and contaminants from entering.

When a communications cable is not connected to the cable connector port, the pressure cap supplied with the instrument should be securely tightened in place.

If moisture has entered the connector, dry the connector completely using compressed air, a clean cloth, or paper towel. Apply a very thin coat of lubricant from the 6570 Maintenance Kit to the O-ring inside the connector cap before each installation.

2.10.2 PROBE CARE AND MAINTENANCE

Once the probes have been properly installed, remember that periodic cleaning and free chlorine membrane changes are required.

6572 FREE CHLORINE PROBES

For best results, we recommend that the KCl solution and the membrane at the tip of the 6572 probe be changed prior to each sonde deployment and, or more frequently if the sensor appears to be drifting as determined by quality assurance tests with a DPD colorimeter. See Section 2.3 for instructions on changing the free chlorine sensor membrane.

After removing the used membrane from the tip of the 6572 probe, examine the electrodes at the tip of the probe. If either or both of the silver electrodes are black in color, the probe should be resurfaced using the fine sanding disks which are provided in the 6035 reconditioning kit.

To resurface the probe using the fine sanding disk, follow the instructions below.

First dry the probe tip completely with lens cleaning tissue. Next, hold the probe in a vertical position, place one of the sanding disks under your thumb, and stroke the probe face in a direction parallel to the platinum electrode (located between the two silver electrodes). The motion is similar to that used in striking a match. Usually 10-15 strokes of the sanding disk are sufficient to remove black deposits on the silver electrodes. However, in extreme cases, more sanding may be required to regenerate the original silver surface.

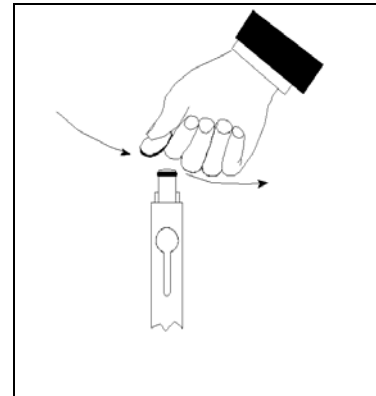

After completing the sanding procedure, repeatedly rinse the probe face with clean water and wipe with lens cleaning tissue to remove any grit left by the sanding disk. After cleaning, thoroughly rinse the entire tip of the probe with distilled or deionized water and install a new membrane.

IMPORTANT: Be sure to: (1) Use *only* the fine sanding disks provided in the 6035 maintenance kit in the resurfacing operation and (2) Sand in a direction parallel to the platinum electrode. *Not adhering to either of these instructions can seriously damage the electrodes.*

NOTE: If this procedure is unsuccessful, as indicated by improper probe performance, it may be necessary to return the probe to an authorized service center. See **Section 8, Warranty and Service Information**, for contact information.

6560 CONDUCTIVITY/TEMPERATURE PROBES

The openings that allow fluid access to the conductivity electrodes must be cleaned regularly. The small cleaning brush included in the 6570 Maintenance Kit is ideal for this purpose. Dip the brush in clean water and insert it into each hole 15-20 times. In the event that deposits have formed on the electrodes, it may be necessary to use a mild detergent with the brush. After cleaning, check the response and accuracy of the conductivity cell with a calibration standard.

NOTE: If this procedure is unsuccessful, or if probe performance is impaired, it may be necessary to return the probe to an authorized dealer service center. See **Section 8, Warranty and Service Information** for contact information.

The temperature portion of the probe requires no maintenance.

6561/6561FG pH AND 6565/6565FG/6566/COMBINATION pH-ORP PROBES

Cleaning is required whenever deposits or contaminants appear on the glass and/or platinum surfaces of these probes or when the response of the probe becomes slow.

Remove the probe from the sonde. Initially, simply use clean water and a soft clean cloth, lens cleaning tissue, or cotton swab to remove all foreign material from the glass bulb (6561 and 6565) and platinum button (6561). Then use a moistened cotton swab to carefully remove any material that may be blocking the reference electrode junction of the sensor.

CAUTION: When using a cotton swab with the 6561 or 6565, be careful NOT to wedge the swab tip between the guard and the glass sensor. If necessary, remove cotton from the swab tip, so that the cotton can reach all parts of the sensor tip without stress. You can also use a pipe cleaner for this operation if more convenient.

If good pH and/or ORP response is not restored by the above procedure, perform the following additional procedure:

1. Soak the probe for 10-15 minutes in clean water containing a few drops of commercial dishwashing liquid.
2. GENTLY clean the glass bulb and platinum button by rubbing with a cotton swab soaked in the cleaning solution.
3. Rinse the probe in clean water, wipe with a cotton swab saturated with clean water, and then rinse with clean water.

If good pH and/or ORP response is still not restored by the above procedure, perform the following additional procedure:

1. Soak the probe for 30-60 minutes in one molar (1 M) hydrochloric acid (HCl). This reagent can be purchased from most distributors. Be sure to follow the safety instructions included with the acid.
2. Rinse the probe in clean water, wipe with a cotton swab saturated with clean water, and then rinse with clean water. To be certain that all traces of the acid are removed from the probe crevices, soak the probe in clean water for about an hour with occasional stirring.

If biological contamination of the reference junction is suspected or if good response is not restored by the above procedures, perform the following additional cleaning step:

1. Soak the probe for approximately 1 hour in a 1 to 1 dilution of commercially-available chlorine bleach.
2. Rinse the probe with clean water and then soak for at least 1 hour in clean water with occasional stirring to remove residual bleach from the junction. (If possible, soak the probe for period of time longer than 1 hour in order to be certain that all traces of chlorine bleach are removed.) Then rinse the probe with clean water and retest.

Dry the sonde port and probe connector with compressed air and apply a very thin coat of O-ring lubricant to all O-rings before re-installation.

6882 CHLORIDE, 6883 NITRATE AND 6884 AMMONIUM SENSORS

You should clean these probes whenever deposits or contaminants appear on the ion selective membranes located on the tips of these sensor modules. If possible, the module should be cleaned while installed in the sonde bulkhead. Use clean water and a moist piece of lens cleaning tissue to *gently* wipe the sensor membranes until no more contaminants are removed. However, under some conditions, it may be necessary to remove the module from the sonde bulkhead for cleaning and/or storage. To remove the module, follow the diagram at the side. Remove the module with finger pressure only, if possible. However, it is acceptable to use small pliers if necessary to loosen the module for final removal by hand. **Be very careful not to squeeze the module any more than is necessary for a firm grip. Use slipjaw pliers to minimize the chance of applying too much pressure on the module.** While the module is removed from the sonde, be sure to dry the sonde port and probe connector with compressed air and apply a very thin coat of lubricant to the O-ring before re-installation.

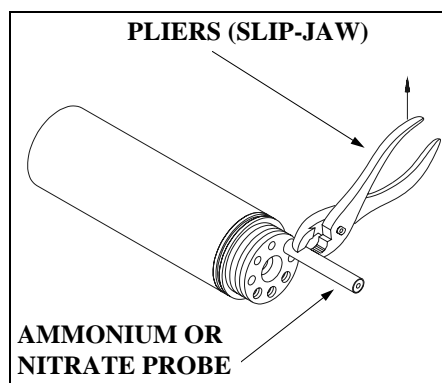

NOTE: The ion selective membranes are fragile. Be certain to: (1) Use only *moist*, high quality lens cleaning tissue for the cleaning procedure (not paper towels or other coarse materials); and (2) Stroke the probe face very gently with the tissue during the procedure. *If you do not adhere to these instructions, you can seriously damage the sensors.*

OPTICAL PROBES—6026 AND 6136 TURBIDITY; 6025 CHLOROPHYLL; 6130 RHODAMINE WT

The 6026, 6136, 6025, and 6130 probes require only minimal maintenance. After each deployment, the optical surface on the tip of the turbidity probe should be inspected for fouling and cleaned if necessary by gently wiping the probe face with moist lens cleaning paper. In addition, for the 6025, 6026, 6136, and 6130 probes, we recommended replacing the wiper periodically. The frequency of this replacement depends on the quality of water under examination. A replacement wiper is supplied with the probes, along with the small hex driver required for its removal and reinstallation. Follow the instructions supplied with the probe to ensure proper installation of the new wiper assembly. Additional wipers are available from YSI.

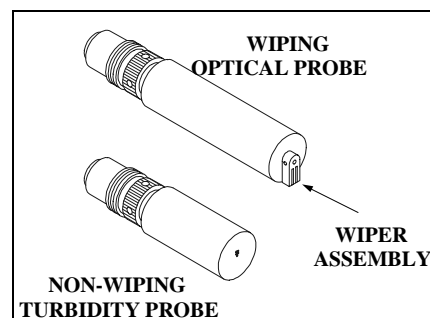

2.10.3 SONDE STORAGE

Proper storage of the your Sonde between periods of usage will not only extend the life of the sensors, but will also ensure that the unit will be ready to use as quickly as possible in your next application.

GENERAL RECOMMENDATIONS FOR SHORT TERM STORAGE

The recommended short term or interim storage procedure is identical for both the 600DW-B and the 6920DW.

No matter what sensors are installed in the instrument, it is important to keep them immersed in water.

YSI recommends that short term storage of the 600DW-B and 6920DW be done **by placing enough water in the sonde calibration/storage cup to completely cover the sensors. The calibration cup should be sealed to prevent evaporation.**

GENERAL RECOMMENDATIONS FOR LONG-TERM SONDE STORAGE

The following are long term storage recommendations for the 600DW-B and the 6920. They will be applicable for sondes with typical sensor configurations.

Remove the pH or pH/ORP probe from the sonde and store it according to the instructions found in the following section on individual sensors. Cover the empty port with the provided plug. Leave the conductivity/temperature and the free chlorine probes in the sonde with a membrane and electrolyte on the free chlorine sensor. Place enough of deionized, distilled, or tap water in the calibration cup to cover the sensors, insert the sonde into the vessel, and seal with the cap/O-ring to minimize evaporation.

2.10.4 PROBE STORAGE

LONG-TERM STORAGE OF PROBES

The following sections provide additional details on the storage of individual sensors associated with instruments in the drinking water (DW) product line from YSI.

TEMPERATURE

No special precautions are required. Sensors can be stored dry or wet, as long as solutions in contact with the thermistor probe are not corrosive (for example, chlorine bleach).

CONDUCTIVITY

No special precautions are required. Sensors can be stored dry or wet, as long as solutions in contact with thermistor probe and conductivity electrodes are not corrosive (for example, chlorine bleach). However, it is recommended that the sensor be cleaned with the provided brush prior to long term storage.

FREE CHLORINE

Free chlorine sensors should always (short-term or long-term) be stored with a membrane and electrolyte in place and the probe tip immersed in tap water (NOT deionized or distilled water). The probe can either be left in the sonde or be removed and stored in a vessel containing water.

Thus, for the 600DW-B and the 6920DW, two long-term storage methods are equally acceptable.

1. Remove all probes other than free chlorine, conductivity, and temperature from the sonde and seal the vacant ports with the provided port plugs. Leave the electrolyte and membrane in place on the free chlorine sensor. Fill the calibration cup with tap water and insert the sonde. Make certain the water level is high enough to completely cover the free chlorine sensor. Seal the vessel to prevent evaporation of the water. At the end of the storage time, remove the existing membrane and re-membrane the probe using new electrolyte.
2. Remove the free chlorine sensor from the sonde leaving the electrolyte and membrane in place. Store the probe in tap water in a beaker, flask, or other vessel of the user's choice. **Be sure not to damage the membrane or the probe tip when placing the probe on the bottom of the vessel.** If possible cover the vessel with parafilm or plastic wrap to minimize evaporation of the water during long-term storage. Monitor the water level in the storage vessel periodically and replenish if loss due to evaporation occurs. At the end of the storage time, remove the existing membrane and re-membrane the probe using new electrolyte.

pH/ORP

The key to pH/ORP probe storage, short or long-term, is to make certain that the reference electrode junction does not dry out. Junctions which have been allowed to dry out due to improper storage procedures can usually be rehydrated by soaking the sensor for several hours (overnight is recommended) in a solution which is 1 molar in potassium chloride (see free chlorine section above for preparation of this solution). If potassium chloride solution is not available, soaking the sensor in tap water or commercial pH buffers may restore probe function. However in some cases the sensor may have been irreparably damaged by the dehydration and will require replacement. It is also important to remember not to store the pH sensor in distilled or deionized water as the glass sensor may be damaged by exposure to this medium.

The recommended long-term storage method for the pH sensor in the 600DW-B and the 6920DW are as follows. Remove the probe from the sonde and seal the vacant port with the provided plug. Place the probe in the storage vessel (plastic boot or bottle) which was in place on delivery. The vessel should contain a solution which is 2 molar in potassium chloride. Make certain that the vessel is sealed to prevent evaporation of the storage solution.

AMMONIUM, NITRATE AND CHLORIDE

The active element in the ammonium and nitrate ion selective electrode (ISE) sensors is a polyvinyl chloride (PVC) membrane that is impregnated with the reagent that provides specificity for either ammonium or nitrate. The useful life of this sensor can be reduced if the membrane is stored immersed in water. Thus, storage in dry air is recommended for long term storage. While dry air is slightly preferable for general storage, the short-term storage of these sensors in the sonde, with the entire sensor array in moist air, will have no significant detrimental effect on the life of the membrane. Remove the sensor module from the 6920DW sonde and cover the vacant port with the provided plug. Place the sensor back in the storage boot that was provided, and set aside in room air.

The chloride ISE sensor utilizes a solid state membrane that provides specificity. For long-term storage, the module should be removed from the sonde, wiped clean with moist lens cleaning tissue, and placed in its storage boot to prevent abrasion.

TURBIDITY, CHLOROPHYLL, AND RHODAMINE

No special precautions are necessary for either the short or long-term storage of the chlorophyll, rhodamine WT, and turbidity probes. However, for long-term storage, the user may wish to remove the probe from

the sonde, replace it with a port plug, and store the probe in dry in air to minimize any cosmetic degradation of the probe body and to maximize the life of the wiper.

SECTION 3 650 MDS DISPLAY/LOGGER

3.1 INTRODUCTION

The YSI 650 Multiparameter Display System (650 MDS) is a powerful, hand held microcomputer based instrument that allows the user to display sonde readings, configure sondes, store and recall data, upload data from sondes and transfer data to computers for analysis and plotting.

Key features of the YSI 650 MDS:

- Completely waterproof case that is submersible to 1 m. Meets IP-67 specification.
- Rugged design with high impact resistance
- Large, non-volatile memory
- Simple cellular phone style keypad.
- Simple intuitive user-interface
- Choice of alkaline batteries or optional rechargeable battery pack
- Fuel gauge display of battery capacity
- User selectable backlight
- Handstrap (standard) or hands free harness (optional) for user comfort
- Optional barometer
- Optional GPS interface
- Compatibility with YSI EcoWatch for Windows data analysis software
- User upgradeable software via the YSI Web page
- CE and Australian C-Tick Compliance.

Partnered with a YSI 6-Series sonde, the 650 will allow the user to easily:

- Display real-time readings from YSI 6-series sondes.
- Log real-time sonde data to internal meter memory with custom site lists.
- Calibrate 6-series sondes.
- Set up 6-series sondes for deployment.
- Upload data from sondes for transfer to PC.

3.2 GETTING STARTED

This section is designed to quickly familiarize you with the hardware and software components of the YSI 650 and its accessories. By the end of Section 3.2 you will have...

- Unpacked the YSI 650 and confirmed that all components are present
- Became familiar with the general features and setup configurations of your YSI 650.
- Installed batteries in the YSI 650.
- Established communication between your 6-series sonde and the YSI 650.
- Viewed data from your 6-series sonde on the YSI 650 display.
- Learned the basics of making alphanumeric entries from the keypad by setting the YSI 650 clock and entering an Instrument ID name.

Successful completion of the above list is essential for you to continue on to Section 3.3, which focuses on the custom setup of the 650. In subsequent sections, you will learn about how to set up sonde menus via the 650 interface, log data to both sonde and 650 memory, and use the GPS and barometer features of the 650.

3.2.1 UNPACKING

Remove the instrument from the shipping box, being careful not to discard any parts or supplies. Use the packing list to ensure all items are included, and inspect all assemblies and components for damage. If any parts are damaged or missing, contact your YSI representative immediately. If you do not know which YSI dealer you obtained your YSI 650 from, refer to Section 8 of your 6-series sonde manual for contact information.

The 650 is offered in four configurations:

- 650-01 – Low memory with no barometer
- 650-02 – High memory with no barometer
- 650-03 – Low memory with barometer
- 650-04 – High memory with barometer

All configurations include the 650 with hand strap and strain relief lanyard installed and the 655174 PC interface cable for use in data transfer to a PC and software updates from a PC. Make certain that you have received these two items (650 itself and PC Interface Cable) during the unpacking process.

The following optional accessories are offered for use with the 650.

- 6113 Rechargeable Battery Pack Kit with 6116 charger adapter cable, 6114 110 volt wall charger, and 6117 battery pack included
- 6126 Rechargeable Battery Pack Kit with 6116 charger adapter cable, 6123 universal charger, European power cable, British power cable, and 6117 battery pack included
- 6127 Rechargeable Battery Pack Kit with 6116 charger adapter cable, 6123 universal charger, China/Australia power cord, and 6117 battery pack included
- 4654 Tripod
- 614 Ultra Clamp
- 5085 Hands Free Harness
- 5065 Form-fitting Case
- 5081 Hard-sided Case
- 6117 Extra Rechargeable Battery Pack
- 6115 GPS Cable for interface with user-supplied GPS unit
- 616 Cigarette Lighter Charger

If you have ordered any of these accessories with your 650, make certain during the unpacking process that you have received them.

3.2.2 UNDERSTANDING THE 650 MEMORY

The 650 is available with two memory options – “low” and “high”.

The less expensive low memory option (650-01 and 650-03) is designed for users who typically use their 6-series sondes in sampling applications and store limited data to their logger. The available memory of the low memory option (ca. 10 kB) will allow the user to log approximately 150 field readings to a single file in the 650 although the exact logging capability is dependent on the number of parameters active in the 6-series sonde. Note also that if multiple files are utilized, the number of logged field readings will be reduced. In addition, the low memory option will also allow the user to upload small files to the 650 that have been logged to the internal memory of sondes during **Discrete** or **Unattended sampling** studies.

The high memory option (1.5 mB) of the 650 is designed for users who log large files directly to the 650 or who wish to upload large (or many) files to the 650 from the internal memory of sondes which have been used to log data in **Discrete or Unattended sampling** applications. For example, with the high memory option, it would be possible to easily upload the data from 7 sondes, each of which have data files in excess of 200 kB or approximately 75 days at a 15-minute Unattended sampling interval.

No matter which memory option has been selected, it is important to understand that the memory resident in the 650 is “Flash”, the same type of memory present in YSI 6-series sondes. Flash memory requires no battery backup and therefore stored data cannot be lost due to instrument malfunction – a significant advantage. However, it is not possible to erase individual files from flash memory – to free-up memory, the user must erase (or format) the entire memory chip. From a practical point of view, this means that, while named files which are already present in the 650 memory can be “overwritten” during multiple uploads, the previously written files still occupy space in the memory. These files are in fact designated “deleted” as will be described in Section 3.6.5 below. For example, if a file named “TEST” is uploaded initially with a memory allocation of 50 kB and then is uploaded at a later time (and “overwritten”) with a memory allocation of 100 kB, the total memory occupied is 150 KB even though only one file with the designation “TEST” and a file size of 100 kB is shown in the file directory. For this reason, when dealing with large files, the user may wish to transfer files to a PC immediately after upload and then erase the entire flash in order to assure that maximum memory is present for subsequent uploads.

The storing of data directly from sondes to the 650 memory, the uploading of data stored in 6-series sondes to the 650, and the management of these data files are described in detail in Sections 3.5, 3.6, and 3.7 of this manual.

3.2.3 650 CONFIGURATIONS

There are a number of ways that you can configure the YSI 650. Below is a list of possible configurations and corresponding diagrams.

- 650 interfaced to a 6-Series sonde.
- 650 interfaced to a 6-Series Sonde and a user-supplied GPS unit.
- 650 interfaced to a PC for data transfer or software upgrade using the PC interface cable
- 650 with rechargeable battery pack being charged

Figure 1. 650 interfaced to a 6-series sonde.

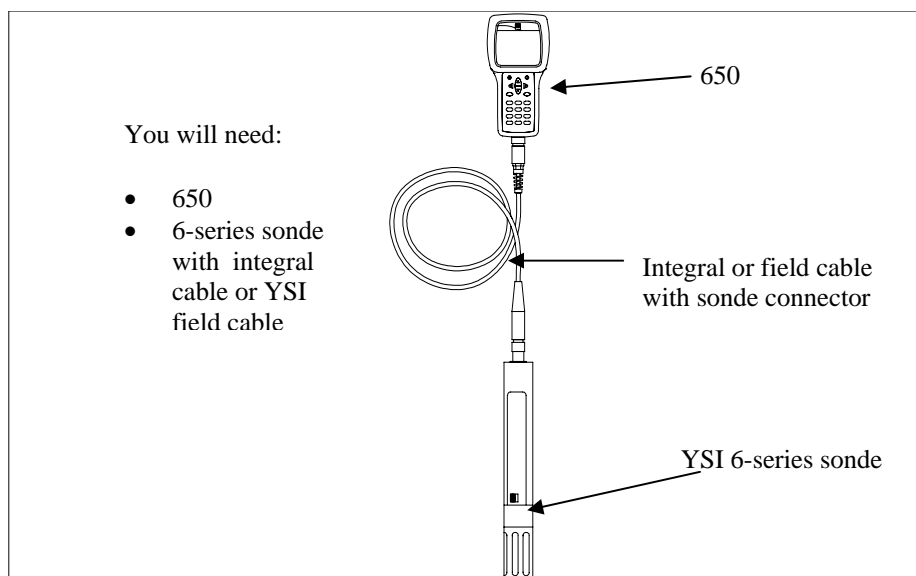

Figure 2. 650 interfaced to a 6-series sonde with user-supplied GPS.

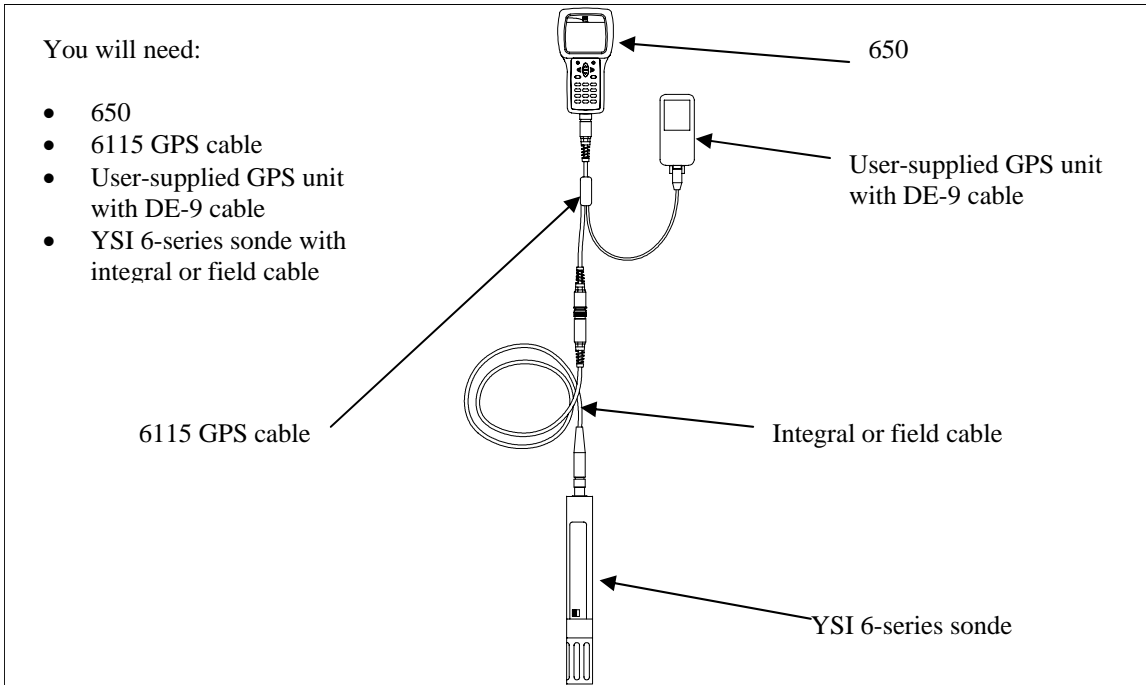

Figure 3. 650 interfaced to PC for data transfer or software upgrade.

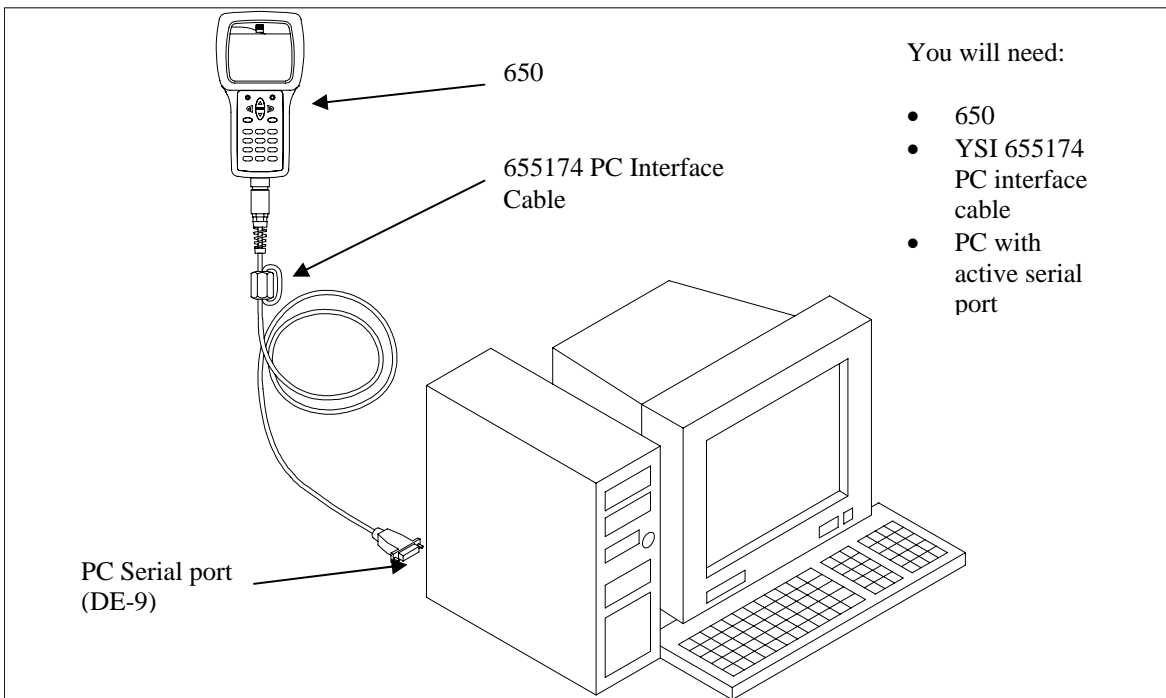
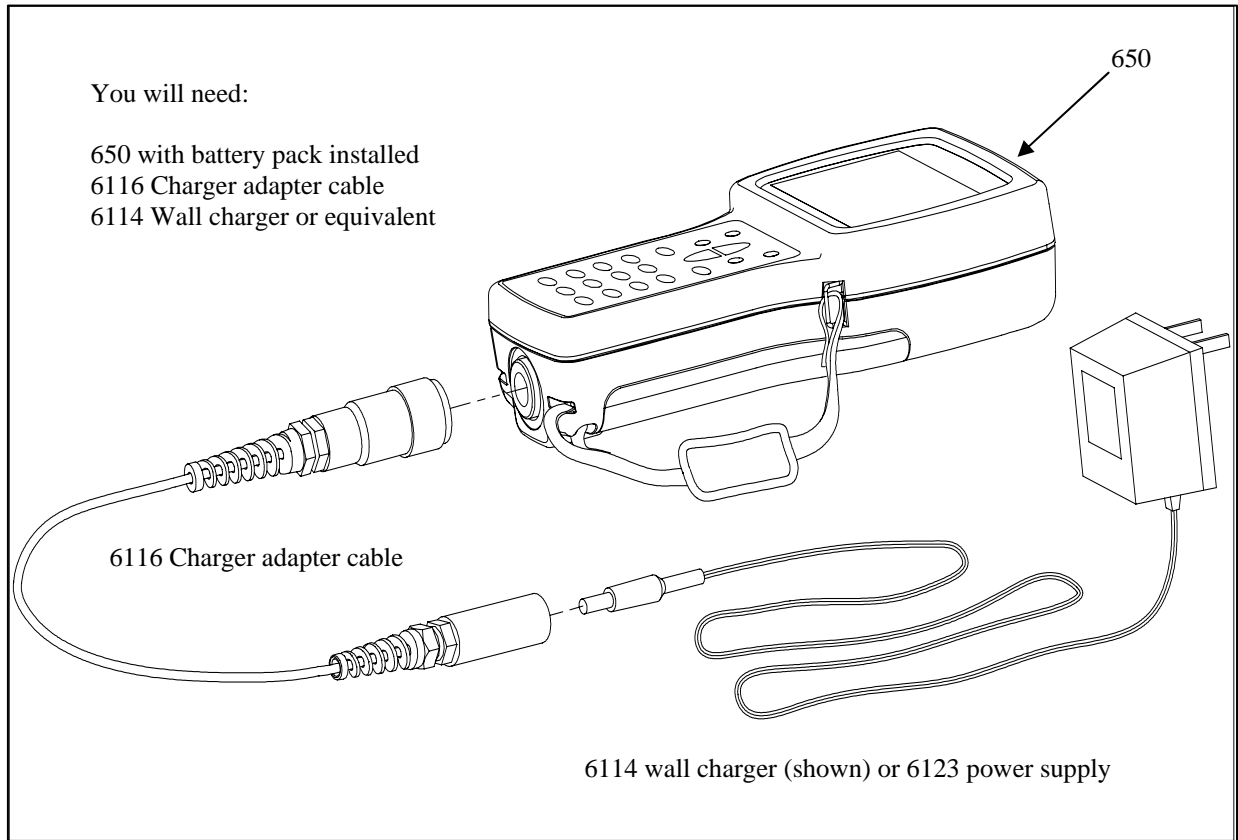

Figure 4. Charging of 650 rechargeable battery pack.







The setup of these configurations is described in detail in subsequent sections of this manual. They are presented here so that you will be able to ascertain if you have all of the parts necessary for your applications.

3.2.4 650 FEATURES

The key physical features of the 650 display and keypad are shown in the figures below.

650 Front View



Note that the YSI 650 keypad consists of 20 keys as shown in the diagram above. There are four function keys, up, down, right and left arrow keys and an alpha/numeric keypad. The top left key that has a green circle and line, , is the ON/OFF key. The top right key, , activates the display backlight. The **Escape** key is labeled  and  is the **Enter** key.

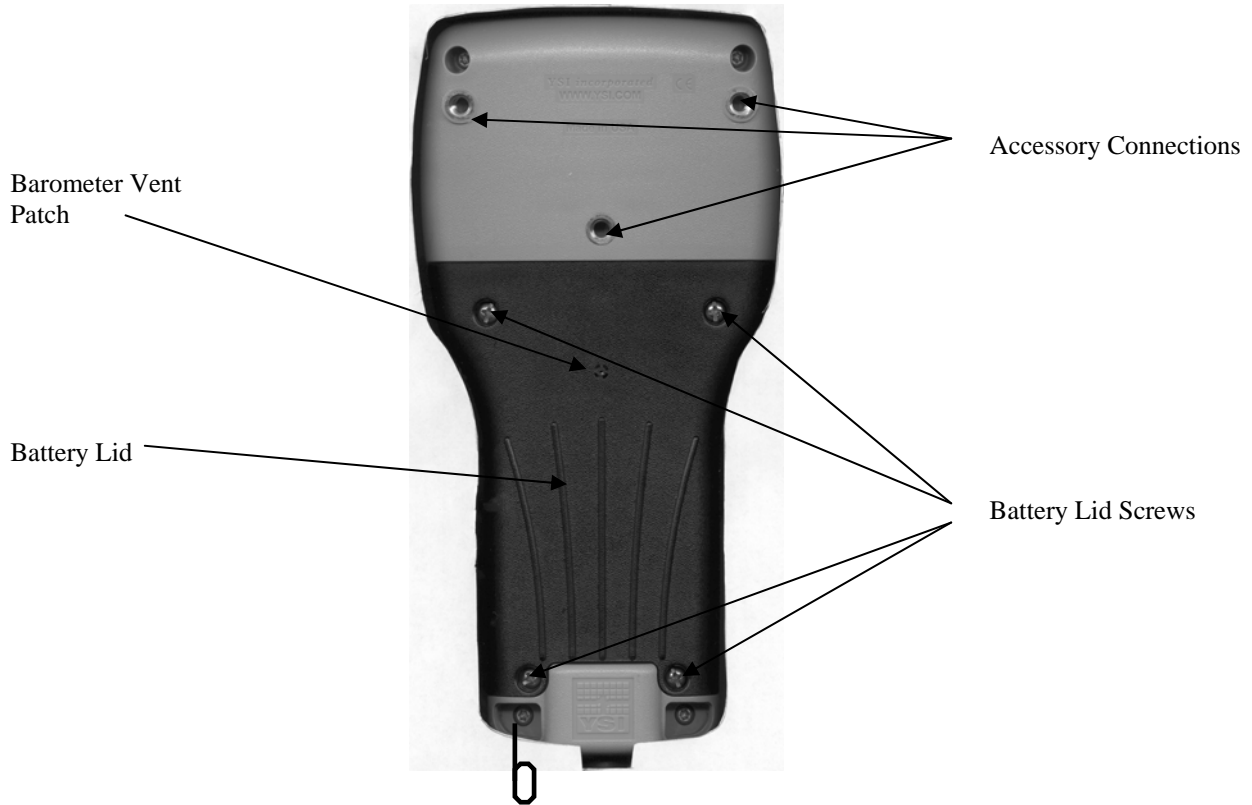

Note that the back of the case contains the battery lid that is attached to the main case with four captive screws and has three fittings for attachment of the ultraclamp and tripod accessories. In addition, the battery lid has a hole that is covered with water-impermeable patch for venting of the optional barometer.

CAUTION: The barometer-venting patch is resident on the inside of the battery lid. Removal of or damage to this patch will result in water leakage into the battery compartment.

The short cord with loop (lanyard) which is attached to the bottom of the case is attached to the strain relief of the sonde cable. Simply open the D-ring, pass the lanyard loop through the opening, and then close the D-ring.

3.2.5 BATTERIES AND CHARGING

The YSI 650 can be powered either with 4 alkaline C cells or a rechargeable NiMH battery pack. With the C-cell configuration, the user will be able to power a typical YSI 6-series sonde (active dissolved oxygen and one optical sensor) for approximately 45 hours of continuous operation. The rechargeable battery pack will allow for about 15 hours of continuous use under these conditions. If the sonde is being powered by its own internal batteries, the 650 batteries will last much longer. YSI Sondes with internal battery capability are the 6920, 6600, 600XLM, and 600 OMS.

3.2.5.1 BATTERY INSTALLATION – C CELLS

Four C cells install easily into the back of the 650. Follow the instructions and diagrams below to install the batteries properly:

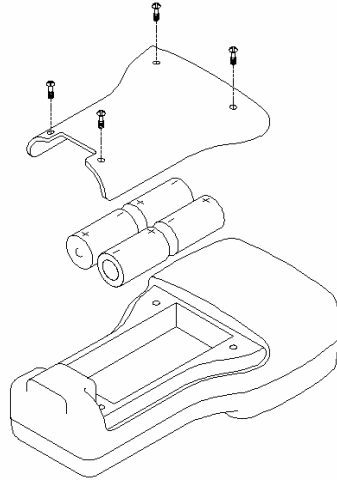

- Using a Phillips or slotted screwdriver, loosen the 4 captive screws on the battery lid and then remove the battery lid completely.
- Insert the cells between the battery clips, being sure to follow the polarity (+ and -) as indicated on the bottom of the battery compartment.
- Make certain that the gasket is properly installed on the battery lid before reinstallation.
- Reinstall battery lid and tighten the 4 captive screws securely and evenly using a Phillips or slotted screwdriver. Do not overtighten.

3.2.5.2 BATTERY INSTALLATION – RECHARGEABLE BATTERY PACK

The YSI 6113 rechargeable battery pack is self-contained and is easily installed according to the instructions and diagrams below:

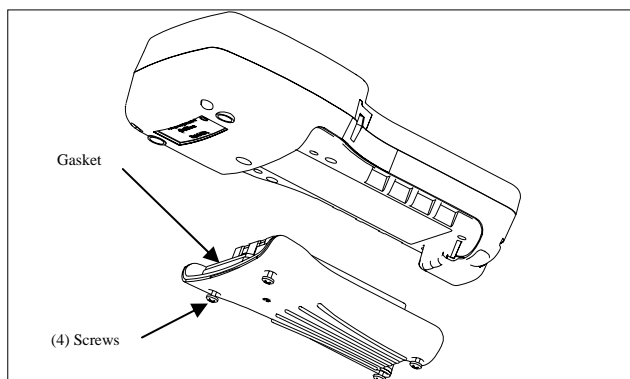

- Using a Phillips or slotted screwdriver, loosen the 4 captive screws on the battery lid and then remove the battery lid completely.
- Put the battery lid in a safe place so that it will be available for future use of C cells.
- Make certain that the gasket is properly installed on the rechargeable battery before installation.

- Insert the rechargeable battery pack assembly into the battery compartment of the 650.
- Tighten the 4 captive screws securely and evenly using a Phillips or slotted screwdriver. Do not overtighten

3.2.5.3 BATTERY CHARGING – RECHARGEABLE BATTERY PACK

The 6117 rechargeable battery pack is charged via the MS-8 connector on the bottom of the instrument and thus the pack must be installed in the 650 for charging. To perform the charging operation, the user will need to locate the proper power supply (6114 for US/Canada/Japan or 6123 with proper power cord for all other countries) and the 6116 charger adapter cable which were supplied with your rechargeable battery pack (6113 for US/Canada, 6126 for Europe, 6127 for China/Australia). As shown in Figure 4 above, first attach the charger adapter cable to the 650, then insert the barrel connector of the power supply into the barrel of the adapter cable, and finally plug the power supply into an appropriate AC power outlet. The pack can be recharged with the 650 either “on” or “off”. However, if the instrument is “on”, the progress of the charging operation can be viewed in the Status Bar (see Section 3.2.10 below).

To ensure that you get maximum operational time from the rechargeable battery pack, the user should follow the procedures below:

1. Place your display/logger on charge for approximately 2 hours to obtain an 80-90 % regeneration of battery capacity.
2. Place your display/logger on charge for approximately 6 hours to get a full charge.
3. Do not charge the batteries continuously for more than 48 hours.
4. For long term storage, keep your battery pack between the temperatures of –20 C and 30 C and remove it from the 650 case.
5. Do not charge your batteries at temperatures below 0 C or above 40 C.
6. Do not use or store the battery pack at high temperature, such as in strong direct sunlight, in cars during hot weather, or directly in front of heaters.

If the above steps are not followed, it may result in a decrease in the operational lifetime of your battery pack. In addition, pay particular attention to the method of long term storage of the battery pack as is outlined in the following warning:

CAUTION: If the battery pack/650 will not be used for extended periods of time, the user should remove the battery pack from the instrument. Failure to do this may result in overdischarge of the pack which can have a detrimental effect of its lifetime

Note that YSI provides recharge options for many countries in the selection of the 6116, 6126, and 6127 kits. However, it is possible that the power cord options in these kits will not be correct for some users. In these cases, users should purchase the 6126 or 6127 kit and substitute their local PC type power cord for the power cord shipped with the kit. This power cord is usually readily available at any local electronics store.

An optional automotive cigarette lighter charger (YSI 616) is also available for recharging the 650 battery pack. Note that the user will require the 6116 adapter cable to use the cigarette lighter adapter. Instructions and diagrams for configuring your cigarette lighter charger and changing fuses are shown below and are found on the back of the 616 package. The user should save these instructions when unpacking the accessory and keep them for later reference.

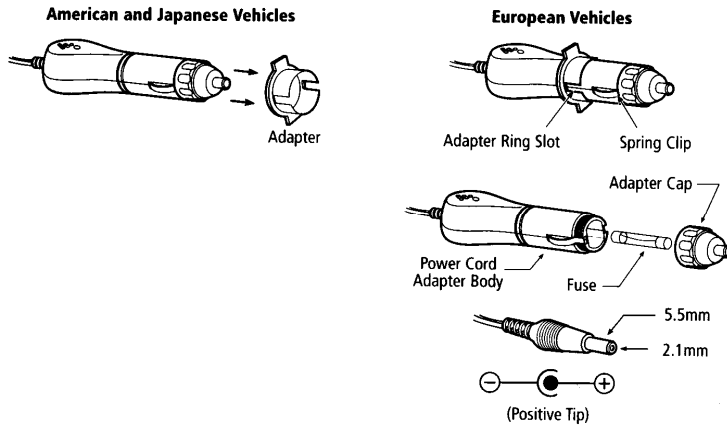

To use the device with an American or Japanese vehicle, slide the adapter ring off of the plug. To use the device with a European vehicle, leave the adapter ring on the plug and position it so the slots on the ring line up with the plug's spring clips. To begin charging your battery pack, first plug the barrel connector of the cigarette lighter charger into the mating end of the 6116 adapter cable. Then attach the MS-8 end of the 6116 adapter cable to the 650. Finally, plug the other end of the cigarette lighter charger into the vehicle's lighter socket.

The 616 cigarette lighter charger contains a 2-ampere fast-blow type fuse. If the power cord stops working properly, unscrew the adapter's cap, remove the tip, and then pull out and check the fuse. See diagram above to remove the fuse. If the fuse is blown or you are unsure, replace it with a new 2-amp fast-blow fuse that is available at electronics stores such as Radio Shack. Reassemble the adapter and securely screw the cap back onto the adapter body.

After you have installed batteries or the rechargeable battery pack into your 650, you are ready to proceed to the next sections.

3.2.6 TURNING THE INSTRUMENT ON

Turn the instrument on by pressing and releasing the on/off button on the top left of the instrument keypad. The following screen should be displayed.

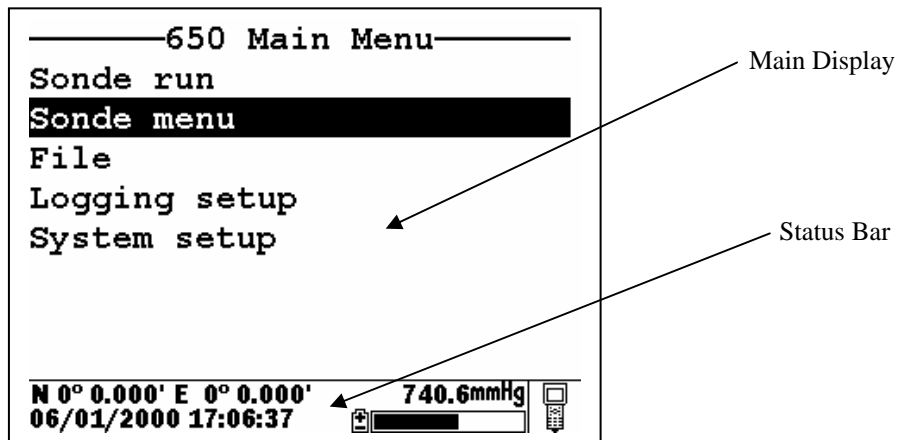

Note that the screen is divided into two sections – the “Main Display” at the top and a “Status Bar” at the bottom. The Main Display will provide access to the 650 and sonde menus and will be used to view sonde sensor readings in real-time, to configure the 650 and the sonde, to calibrate the sonde sensors, and to log data to either sonde or 650 memory. The Status Bar will always show the date and time of the 650 clock (updated in real-time), the remaining battery capacity, the current barometer reading if you have purchased this option, the GPS readings from a user-supplied GPS instrument, and will indicate whether the menu being viewed in the Main Display is associated with your sonde or the 650. Additional information about the Status Bar will be provided in Section 3.2.10 of this manual.

You may also want to take the instrument into a dark room and, with the instrument turned ON, press the backlight key which is located at the top right of the keypad. The instrument backlight should illuminate the LCD so that the display can be read. Pushing the backlight key again will turn the backlight off. The backlight will power off automatically after two minutes of non-use.

3.2.7 ADJUSTING THE DISPLAY CONTRAST

The contrast of the 650 display is automatically temperature compensated to provide a proper display under most field conditions (-10 to 40 C). Some users, however, may wish to alter the display contrast to meet their own preference. In addition, if the instrument is used at more extreme temperatures, the display is likely to require some adjustment.

The contrast is easily adjusted by pressing and holding down the backlight key in the upper right of the keypad and then pressing repeatedly or holding down the up/down arrow keys while observing the display. Pressing the up arrow while holding down the backlight key increases (darkens) the contrast; pressing the down arrow under these conditions decreases (lightens) the contrast.

NOTE: The backlight itself will only be activated if the backlight key is pressed and released. You must hold down the backlight key to adjust the contrast.

3.2.8 USING THE YSI 650 KEYPAD

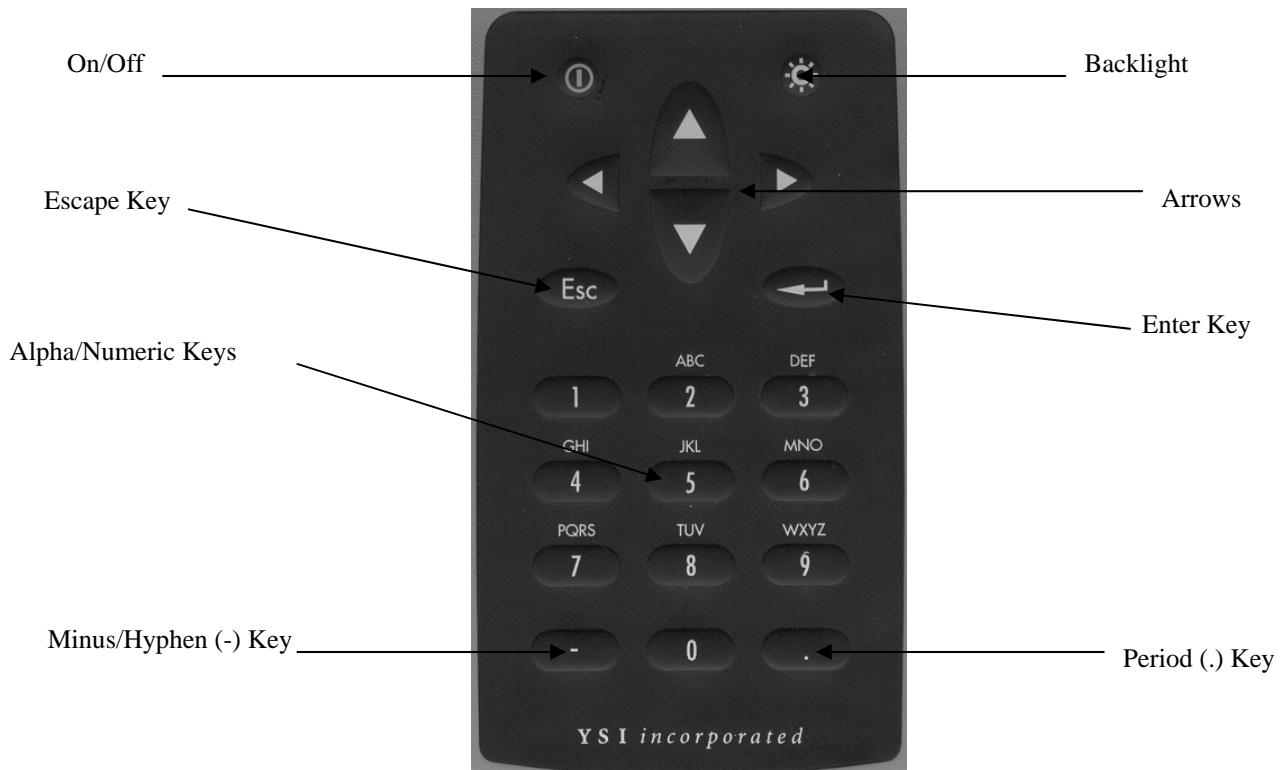

The 650 keypad allows the user to navigate various sonde and 650 menu selections and to make alpha/numeric entries into both the 650 and sonde software. The arrow keys are used to select various options in the menus; the cellular phone-style alpha/numeric keys allow data entry; the **Enter** key is used to confirm selections; and the **Escape** key returns the user to the previous position in the menu structure.

The alpha/numeric keys of the 650 can be used to enter both numbers and letters. For many entries, however, where only numbers are appropriate, the software automatically allows **ONLY** numeric entry, e.g., the letters (ABC) associated with the "2" key cannot be activated. Examples of this type of fixed numeric entry include setting the clock of the 650 or sonde, entering calibration parameters for sonde sensors, and changing entries such as DO warm-up time and optical wiper interval in the **Sonde Advanced|Sensor** submenu. You will follow an example of this type of entry when you set the 650 clock in the example below.

When both numeric and alpha entry are appropriate for input, the 650 keypad provides a cellular phone-style interface for choosing the proper character. As shown in the above diagram, the 2-9 keys can also be used to input alpha characters. Basically, to activate a particular alpha/numeric character, the user must press the appropriate key repeatedly until the desired letter or number appears in the display. For example, to enter an M, press the numeric 6 key once and release. To enter an N, press the numeric 6 key twice in rapid succession and then release. Lower case letters are also available for input using this basic method. The following chart shows the alpha/numeric sequence available for each numeric key in the order they will appear as the key is pressed repeatedly.

- 1 -- 1
- 2 – ABC2abc2
- 3 – DEF3def3
- 4 – GHI4ghi4
- 5 – JKL5jkl5
- 6 – MNO6mno6
- 7 – PQRS7pqrs7
- 8 – TUV8tuv8
- 9 – WXYZ9wxyz9
- 0 -- 0

Using this guide, it can be seen that the character “p” will appear and remain in the display by pressing the 7 key six times in succession. The other characters associated with this key (“P”, “Q”, “R”, “S”, and “7”) will appear during the repeated pressing of the numeric 7 key. However, only the “p” entry will be retained after the key is released after the six keystrokes.

After release of the numeric key for approximately 1 second, the cursor will automatically scroll to the right to prepare for the next alphanumeric input. If you make a mistake in the entry, simply return to the previous character with the left arrow key and reenter the number or letter. After the entry is complete, press the **Enter** key to confirm it. You will follow an example of this type of entry when you enter an Instrument ID name for your 650 in the example below.

To familiarize yourself with the basics of the keypad entry system, follow the instructions below to set the date and time for your 650 and to enter an Instrument ID:

Turn the instrument on to display the **650 Main menu**.

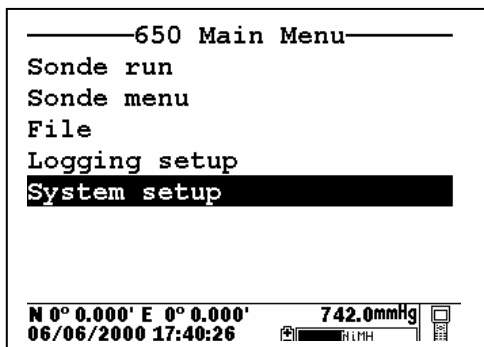

Use the arrow keys to highlight the **System setup** selection and press the **Enter** key. A display similar to the following will appear (Note that the exact format of your displays will depend on the software version):

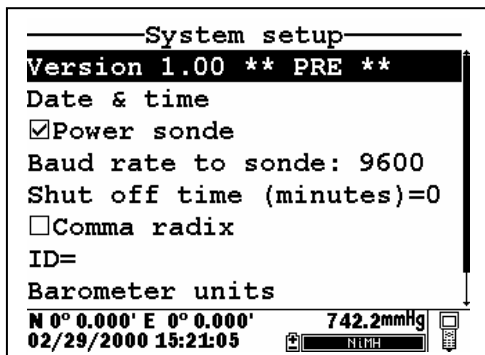

Use the arrow keys to highlight the **Date and Time** selection and press the **Enter** key. The following display will appear:

```

-----Date & time setup-----
●m/d/y
○d/m/y
○y/m/d
☑4 digit year
Date=05/31/2000
Time=11:54:24

N 0° 0.000' E 0° 0.000'      740.8mmHg
05/31/2000 11:54:24

```

Highlight the selection for your desired date format and press **Enter** to confirm it.

Highlight the 4-digit year selection and press **Enter** to toggle between 2-digit (no check mark present) and 4-digit (check mark present) options.

Highlight the **Date** selection and press **Enter**. A cursor will appear over the first number in the date as shown in the following display.

```

-----Date & time setup-----
●m/d/y
○d/m/y
○y/m/d
☑4 digit year
Date=05/31/2000
Time=11:55:24

N 0° 0.000' E 0° 0.000'      740.7mmHg
05/31/2000 11:55:30

```

Enter the proper number from the keypad for the first date digit. Note that when you release the key, the cursor moves automatically to the next number. Repeat this process until the date is correct. Then press **Enter** to confirm the Date entry. Note also that, as described above, since alpha characters are inappropriate for this entry, only numeric entry is possible.

Highlight the **Time** selection and press **Enter**. Repeat the process described above for the **Date** to enter your correct local time using the military format. For example, 2:00 PM must be entered as 14:00.

Finally, press the **Escape** key to return to the System setup menu.

Now highlight the **Instrument ID** selection and press **Enter**. The following display will appear.

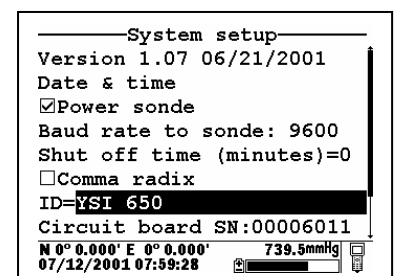
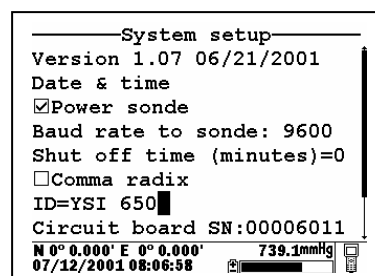
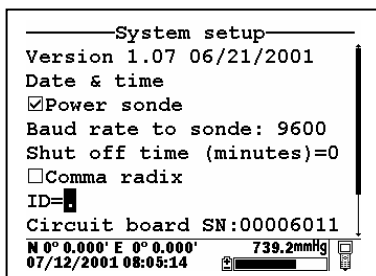
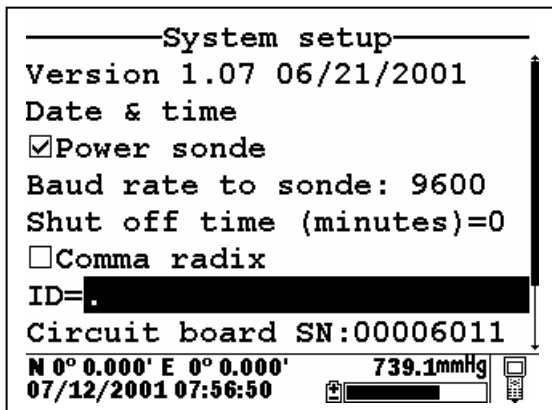

As shown above, enter the designation “YSI 650” using the general instructions outlined above. Start by pressing the numeric 9 key three times in rapid succession while viewing the characters on the display until a “Y” appears. After the entry is complete, pause and the cursor will automatically move to the next entry position. Now press the numeric 7 four times in succession while viewing the characters on the display. When an “S” appears, pause and the cursor will move automatically to the next entry position. Continue with the entries in this way until ID designation is complete. If you make a mistake, you can use the left arrow key to highlight the flawed entry and correct it. When the entry is complete, press **Enter** to confirm it. Note that for this example, where both alpha and numeric entries are appropriate, the user must press the numeric 2 key 4 times in succession to generate the number 2, as opposed to the previous clock-setting example where a single press of the numeric 2 key generated the number 2.

After completing the above example, press the **Escape** key repeatedly to return to the **650 Main menu** and then proceed to the next section.

3.2.9 CONNECTING TO A SONDE

The primary use of the 650 is to interface with YSI 6-series sondes. In this configuration, you will be able to see data from the sonde sensors in real-time on the 650 display as well as to configure the sonde for your particular application. In addition, once sonde interface is established, you will be able to easily log data from the sonde sensors to either the memory of the sonde or the memory of the 650 for later analysis.

The connection between the sonde and the 650 is made via the mating of MS-8 connectors on the standard YSI field cable and the bottom of the 650 case. To make the connection, hold the 650 in one hand, place the 650 and cable connectors together, and rotate the field cable connector until engagement occurs. Then rotate the field cable connector approximately 1-quarter turn until it is fully engaged as evidenced by a

“click”. After connecting the sonde to the 650, press the “on” button on the upper left of the 650 keypad to activate the **650 Main menu** as shown below:

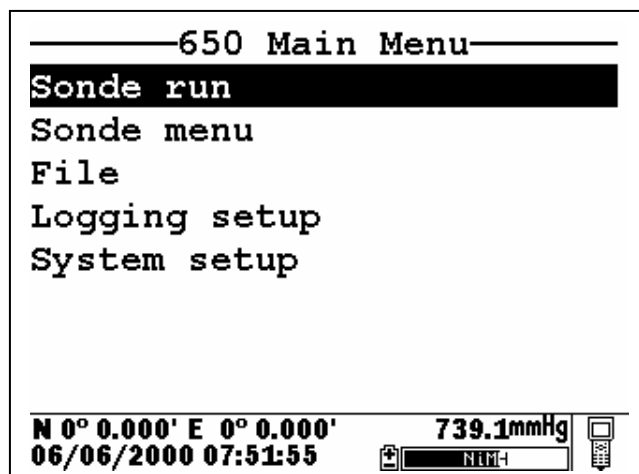

Using the arrow keys, highlight the **Sonde run** entry in the Main 650 Menu and press the **Enter** key. Readings from the 6-series sonde sensors will appear on the 650 Main Display in real-time as shown in the following diagram.

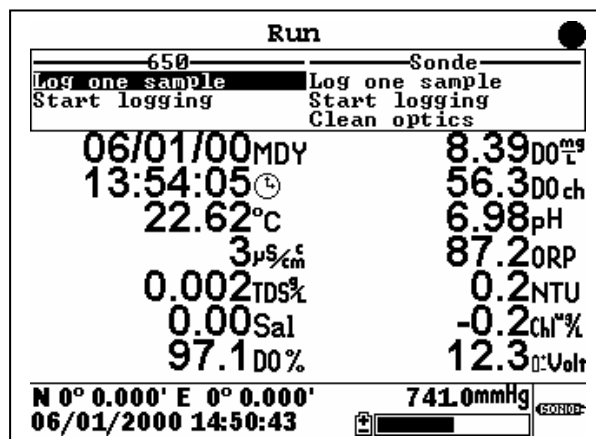

The two windows at the top of the display give the capability of logging the displayed readings to either the 650 (top left) or the sonde (top right) memory and allow the user to activate the wiper on turbidity, chlorophyll, and rhodamine WT probes if they are present in the sonde. Instructions for use of these windows are provided in subsequent sections of this manual. Note also that there is a disk with rotating segments in the upper right corner of the display whose movement confirms that the 650/sonde interface is functional.

To return to the **650 Main menu**, press the **Escape** key.

CAUTION: When using the 650 MDS in field applications which are in close proximity to communication towers and heavy industrial equipment, or which involve very low humidity conditions, the user may experience problems with logger function. If possible, the user should relocate the sampling site away from these potential sources of interference. In most cases, symptoms will involve instrument shutdown or display lockup. These problems can usually be overcome by either simply pressing the on/off key to reactivate the meter display or by resetting the instrument by removal of battery power as described in

Section 3.11 of this manual. If symptoms persist after these actions, consult YSI Customer Service for advice.

3.2.10 UNDERSTANDING THE STATUS BAR

The diagram below shows the various components of the Status Bar of your 650. Each item identified in the drawing is explained in detail below.

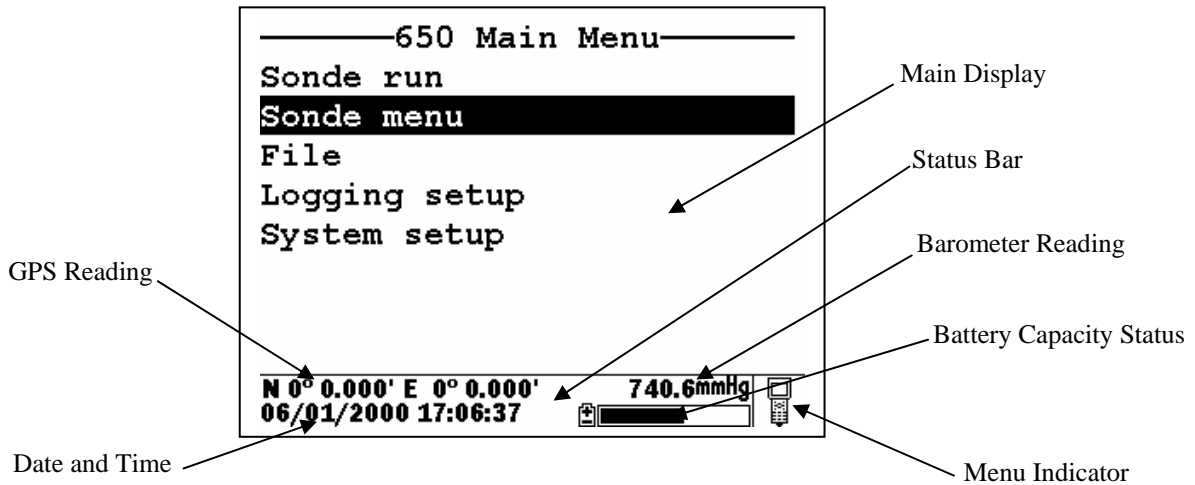

2.10.1 Date and Time. This is the date and time for the clock in the 650, set by the user from the **System setup** menu as described above. The date and time entries are updated in real-time in the Status Bar.

2.10.2 GPS Reading. This value will be present only if a user-supplied GPS unit with NMEA 0183 format is connected to the 650 by the optional YSI 6115 cable. The setup of a GPS interface is described in more detail in Section 3.8 below. Once properly connected to a GPS instrument, the values displayed in the Status Bar are updated in real-time as the system is moved from location to location.

2.10.3 Barometer Reading. This value is the current local barometer reading in units selected by the user in the **System setup** menu. The value can be used simply as a meteorological parameter or can be used in calibration of sonde dissolved oxygen sensors. The barometer reading is NOT corrected to sea level and is updated in real-time.

2.10.4 Battery Capacity Status. The graphic indicator shows the portion of the battery capacity that is remaining, either for the 4-C cell configuration or for the optional rechargeable battery pack. If a 6117 rechargeable battery pack is in place, a "NiMH" label will appear as part of the indicator. During charging of the battery pack, the black portion of the icon will pulse horizontally until charging is complete. In addition, the entire battery indicator will flash when your batteries are almost exhausted and require replacement (C-cells) or recharge (optional rechargeable battery pack).

2.10.5 Menu Indicator. This icon is located in the lower right portion of the Status Bar and provides a guide as to whether the menu on the display of the 650 originates in the sonde or the 650 itself. The icon shown in the figure above represents a 650 menu; if the menu on the display had originated in the sonde, the Status bar would display a sonde-like icon as shown below.

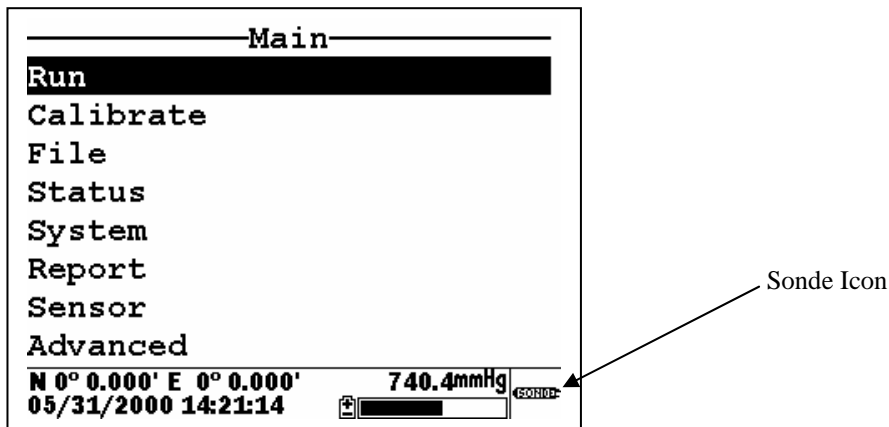

3.2.11 UPGRADING ECOWATCH FOR WINDOWS SOFTWARE

To utilize the full capability of the 650 MDS, you will need to upgrade your version of EcoWatch for Windows from the YSI World Wide Web page (www.ysi.com). Access the YSI Environmental Web Page, select "tech support" from the header, and then "Downloads". After registration, select the EcoWatch for Windows upgrade entry and follow the instructions provided. After the upgrade is complete, your software version (viewed from the EcoWatch toolbar entry **Help|About EcoWatch**) should be 3.13.00 or higher.

If you encounter difficulties in the upgrade procedures, contact YSI Customer Service for advice.

After reading the above sections and participating in the simple examples provided, you should be familiar with the basics of battery installation, keypad and display function, and keypad data entry. Please proceed to Section 3.3 where the setup of your 650 is described in detail.

3.3 SETTING UP THE 650

The 650 has a number of features which are user-selectable or which can be configured to meet the user's preferences. Most of these choices and selections are found in the **System setup** selection in the Main 650 Menu. To explore the various setup possibilities of the 650, turn the instrument on, select **System setup**, and press **Enter**. The following display will appear. The second display can be observed by scrolling to the bottom of the **System setup** entries with the down arrow.

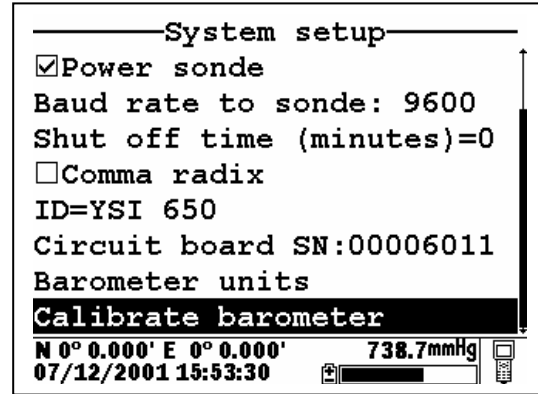
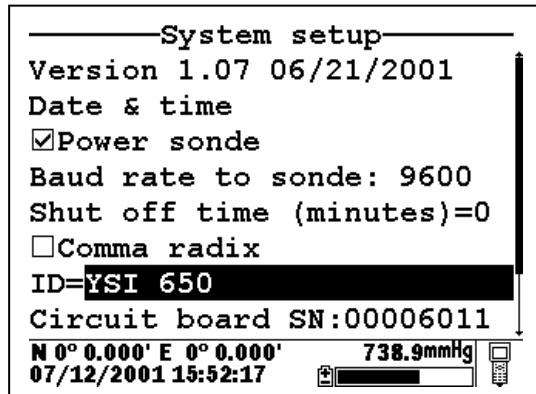

YSI suggests that the user become familiar with the features provided in the list below prior to using the 650 in field applications. Each item is described in some detail below.

3.3.1 Software version

The software version of your 650 is shown in the first line of the **System setup** menu. As enhancements are introduced to the 650, you will be able to upgrade your 650 from the YSI web page. This item will be used to track those upgrades and will be useful to YSI Customer Service personnel if you have questions about the function of the instrument.

3.3.2 Date and time:

As described above in Section 3.2.8, activate this selection to set the date and time from the 650 keypad.

3.3.3 Power sonde:

If this choice is active, your 6-series sonde will be powered directly from the 650 batteries. The choice **MUST** be active if you are using a sonde with no internal batteries (600R, 600XL, or 6820). If using a sonde with internal batteries (600XLM, 6920, 600 OMS battery version, or 6600), you can extend the life of your 650 batteries by deactivating this selection. Note that the selection **MUST BE OFF** in order to determine the voltage of the internal batteries of sondes – important information for Unattended studies.

3.3.4 Baud rate to sonde:

This entry allows the user to adjust the baud rate for communication with the sonde. It does not affect communication for upload of files to a PC. Highlight the entry and press **Enter**. Then select the baud rate of choice and press **Enter** to confirm it. **CAUTION:** The baud rate for the 650 **MUST** match that in the sonde (usually set at 9600) or communication with the sonde will not be possible. Unless you know that your sonde is set to a baud rate different than 9600, YSI strongly recommends that you leave the baud rate for the 650 set to the default value of 9600.

3.3.5 Shutoff Time:

This value represents the number of minutes until the 650 automatically shuts down to save batteries. Values can be integers from 1 to 15 or enter “0” to disable the shutoff completely.

3.3.6 Comma radix:

The user can toggle between a period (default) and comma for the radix mark by selecting this item and pressing the **Enter** key. If you change your radix mark in the 650, make sure that you also change it to the same symbol in the sonde **Advanced|Setup** menu.

3.3.7 ID

Activate this item and **Enter** choice of instrument identification (limit 11 characters) for your 650 as described in Section 3.1.8 above.

3.3.8 Circuit board SN

This item identifies the serial number of the circuit board resident in your 650. It cannot be changed by the user.

3.3.9 Barometer Units:

Highlighting this selection and pressing **Enter** will activate a display which will allow you to select the units of barometric pressure which will appear in real-time in the display Status Bar. Highlight the desired units and press **Enter** to confirm the selection. This entry will only appear if you have ordered your 650 with the barometer option.

3.3.10 Calibrate Barometer

You may need to scroll down with the arrow keys to view this selection which allows you to calibrate the optional barometer to your local barometric pressure. While the barometer has been factory calibrated and should provide accurate readings on receipt, some sensor drift may occur over time, requiring occasional calibration by the user. Proceed as follows:

Determine your local barometric pressure. This value is usually obtained from an independent laboratory barometer. You can also obtain a barometric pressure value from your local weather service. This latter value has usually been corrected to sea level and therefore must be “uncorrected” before it can be used in calibration of the 650 barometer. See Section 3.9 of this manual for details.

Select **Calibrate barometer** and press **Enter**. Input the known barometric pressure from the 650 keypad in the selected units (mm Hg in the following example) and press **Enter**. Note that in the example, the barometer output has changed from 733.4 (the previous incorrect value) to 740 (the correct value from your laboratory barometer). Note also that a value of the approximate barometer offset which occurred during the calibration (6.3 mm Hg) is present in the display. The offset value is approximate due to the variation in the tenths of a mm digit of the sensor. This value can be used to return the sensor to its factory calibration; simply recalibrate the sensor to a new value which is determined by (current value) – (offset).

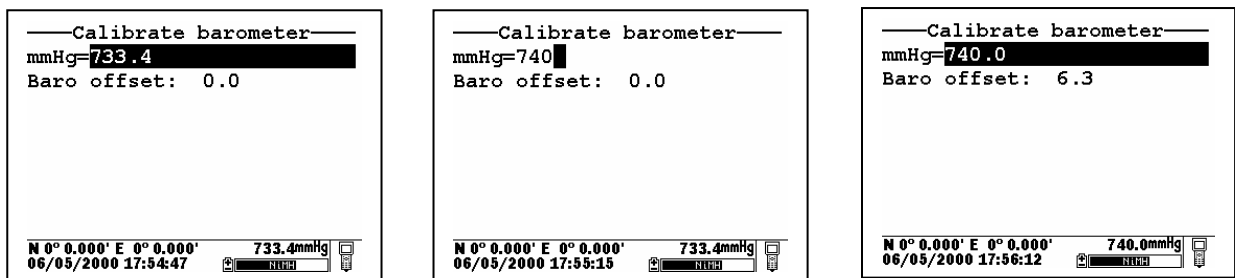

Note that this entry will only appear if your have ordered your 650 with the barometer option.

NOTE: After initial calibration of the barometer, a file with a name defined by the Circuit Board ID and a .glp extension (e.g., 00003245.glp) will automatically be generated and stored in 650 memory. Each additional barometer calibration record for will also be stored. See Section 6.3 below for the transfer of this file to a computer for viewing and storage.

3.4 SONDE MENU INTERFACE

3.4.1 INTRODUCTION

The **Sonde menu** selection in the **650 Main menu** provides a terminal-like interface simulating the connection of the sonde to a PC as described in detail in Section 2 of the 6-series manual. Thus, this item provides access to the entire menu structure of your 6-series sonde software so that you can perform custom setup in the same way that would be possible if the sonde were attached to a PC.

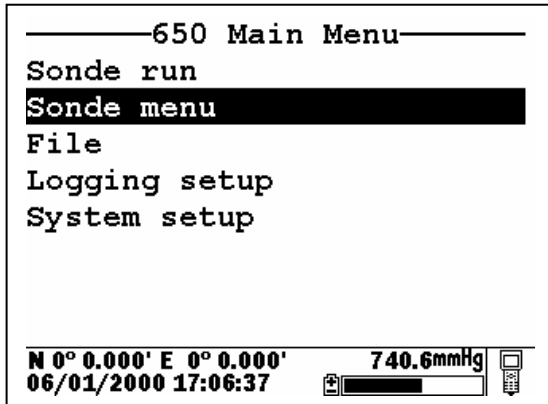

From the **650 Main Menu**, select **Sonde menu** and press **Enter**. A display similar (depending on sonde type and sonde software version) to that shown below will appear:

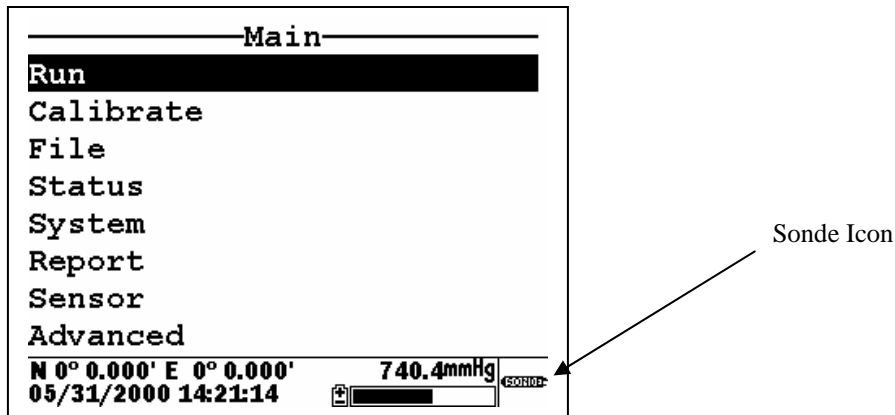

Note that the icon in the lower right of the screen has changed from “meter” to “sonde” indicating that the menu shown originates in the 6-series sonde. Note also that the 650 display has been designed to be very similar to that presented on a monitor when a 6-series sonde is attached to a PC as shown below.

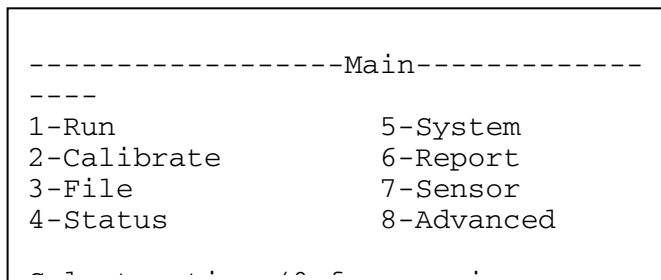

In fact, the only significant difference between the two interfaces is that, for the PC mode, submenus are accessed by entering the number associated with the specific item, while for the 650 mode the user must use the arrow keys to highlight the item and press the **Enter** key to activate it. Thus, the description of the 6-series sonde menu structure and function which is found in your sonde manual is completely valid as a reference for setting up your sonde for all types of studies. The menu structure of the sonde is presented in diagram form below, followed by two examples in Section 3.4.2 of how to use the **650 Sonde Menu** interface. In addition, brief instructions for frequently performed sonde operation are provided as a reference in Section 3.4.3 below.

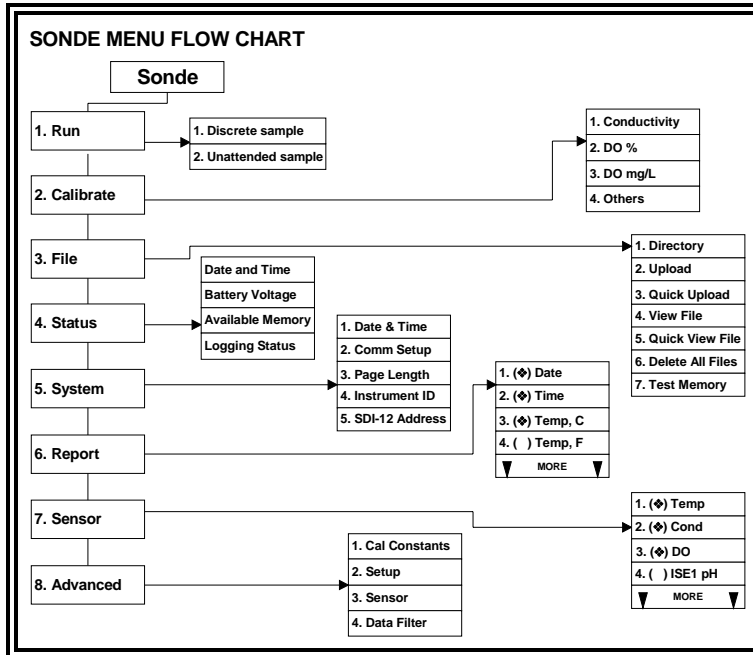

NOTE: When using the 650, all sonde functions are accessed through the **Sonde menu** prompt. These include:

- Activating/Deactivating sensors
- Setting up the desired Report output
- Calibrating the sensors
- Changing the sample interval for Discrete Sample studies
- Performing file management functions on the memory in the sonde
- Checking the **Status** or **System setup** of the sonde.
- Setting up sondes for **Unattended sample** deployments.
- Setting up sondes for **Discrete sample** logging studies to sonde memory.
- Uploading files from the sonde memory to the 650.

Earlier YSI display/loggers, such as the 610 D and 610 DM, had many of these functions as distinct items in the display menu structure – a significant difference from the 650.

3.4.2 SONDE MENU EXAMPLES

To become familiar with the **650 Sonde menu** function, YSI recommends that the user connect a sonde to their 650 and proceed through the following two examples of common sonde interface operations.

Example 1: Setting up the Report Output – Activation of the Salinity Parameter

Highlight the **Sonde menu** selection in the 650 Main menu and press **Enter**. Then use the arrow keys to highlight the **Report** selection and press **Enter** again.

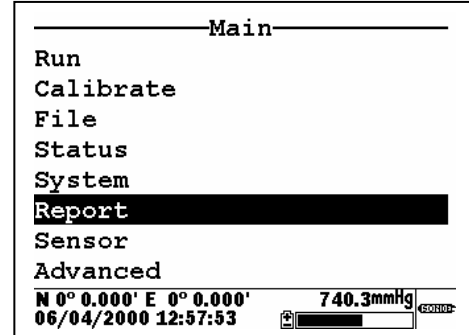
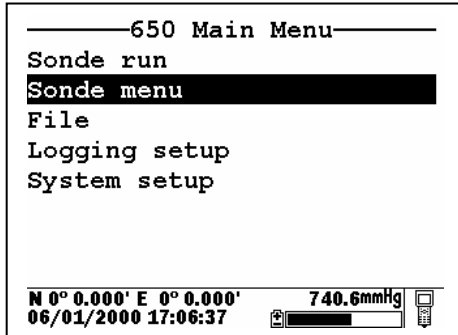

Use the arrow keys to highlight the **Salinity** selection and then press the **Enter** key to activate the parameter as shown by a dot in the open circle. Note that the entire report list can be accessed by continuing to scroll the highlighting block down with the arrow key. After activation of salinity in the **Report** setup of the sonde, press the **Escape** key twice in succession to return to the **Main sonde** menu.

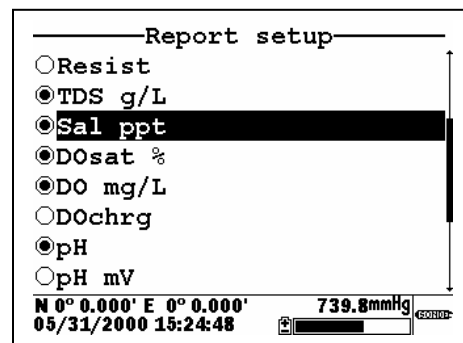
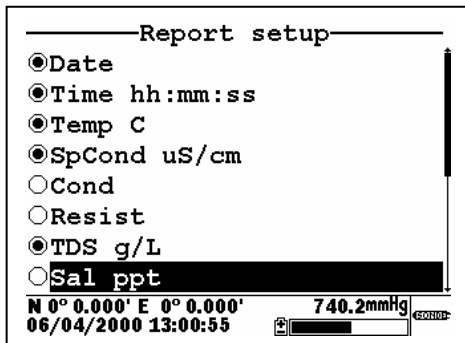

Example 2: Calibrating the Dissolved Oxygen Sensor

NOTE: In the following example, it is assumed that the **Autosleep RS232** function of your sonde has been disabled in the sonde **Advanced|Setup** menu. If **Autosleep** were active, then the display would indicate a countdown of the DO warm-up time and calibrate automatically at the end of this time period. See Section 3.4.9 of this manual and Section 2 of your 6-series manual for more information on the **Autosleep** function.

Place the sonde in the calibration chamber with the dissolved oxygen probe in water-saturated air.

Highlight the **Sonde menu** selection in the 650 Main menu and press **Enter**. Then, use the arrow keys to highlight the **Calibration** selection and press **Enter**.

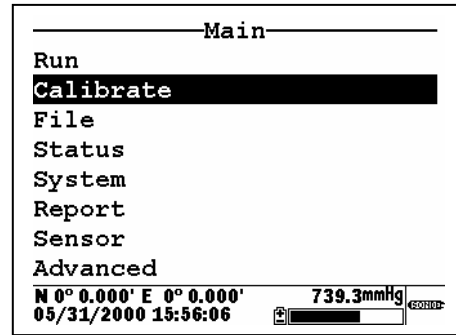
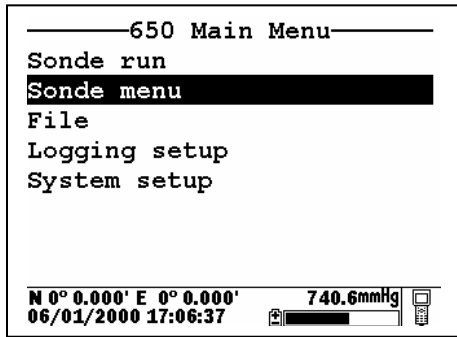

Use the arrow keys to highlight the **Dissolved Oxygen** selection and press **Enter**. Then, Use the arrow keys to highlight the **DO%** selection and press **Enter**.

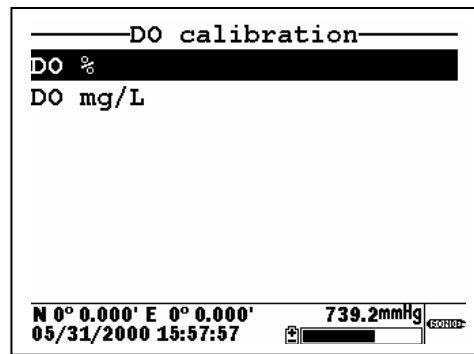
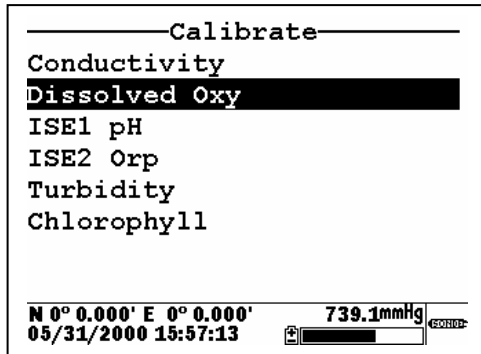

Use the 650 numeric entry keys and the right/left arrow keys to enter the current local barometric pressure. Then, press the **Enter** key and observe the dissolved oxygen reading until stabilization occurs. Make sure the **Calibrate** selection is highlighted in upper window.

NOTE: The current barometric pressure as read by your 650 will automatically appear as the default value if your 650 is equipped with a barometer.

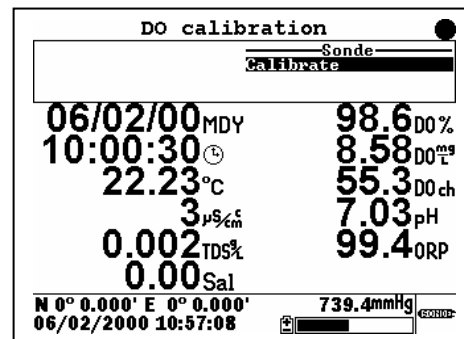
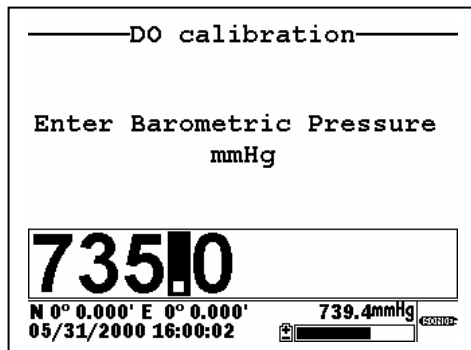

When the dissolved oxygen reading is stable, press the **Enter** key to confirm the calibration as indicated by the message “Calibrated” in the header. In addition, the message in the upper window will change from

“Calibrate” to “Continue”. Make sure that “Continue” is highlighted and press **Enter** to return to the **DO calibration** menu.

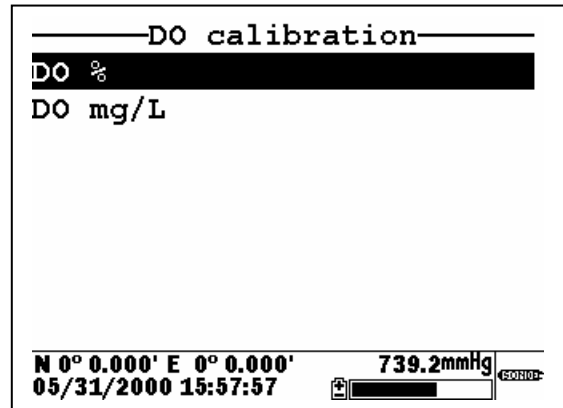
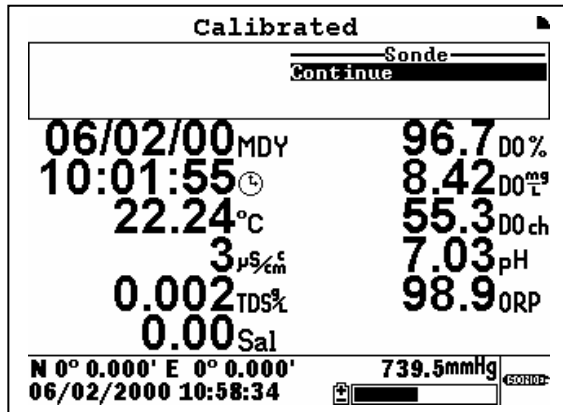

3.4.3 COMMON OPERATIONS USING THE 650 SONDE MENU SELECTION

The following section provides brief instructions for carrying out frequently used sonde activities via the **Sonde menu** selection of the 650. The instructions do not provide the detail of the examples above, assuming that the user understands how to navigate the menus with the **Enter**, **Escape**, and **Arrow** keys and is able to make alpha/numeric entries from the keypad.

3.4.3.1 Running the sonde in real-time

This function can be accomplished either automatically from the **Sonde run** selection of the 650 menu or by using the **Sonde menu** selection to activate the **Run|Discrete Sample** submenu of the Main 6-series menu. If the **Sonde run** selection is made, data automatically appears on the screen at a sample interval of approximately 1 second. However, if the user chooses to use the **Run** function from the sonde menu, the sample rate can be set to higher values in the Discrete Sample menu. This feature will be described in detail in Section 3.5.2. To **Run** the sonde from the **Discrete sample** menu, highlight **Start sampling** and press the **Enter** key.

3.4.3.2 Setting up a sonde for deployment

Use the **650 Sonde menu** selection to access **Run|Unattended sample** and then proceed with the setup for the monitoring study as described in detail in Section 2 of the 6-series manual. Use the keypad to set the sample interval and input file and site names. Then highlight **Start logging** and press **Enter** to begin the Unattended study in which data is logged directly to the sonde memory. Finally, disconnect the 650 and deploy the sonde.

3.4.3.3 Uploading data from sondes to the 650

Use the **650 Sonde menu** selection to access the sonde **File** menu and then choose either a **Quick upload** (all data in the last file) or **Upload** (complete or partial data in any sonde file) as described in detail in Section 2 of the 6-series manual. After the proper selection is made, press **Enter** and the file will be transferred automatically to the 650 memory with the 650 display indicating that an upload is in progress. The uploading of data files from sondes to the 650 is demonstrated in greater detail in Section 3.7 below.

3.4.3.4 Calibrating sonde sensors

Use the **650 Sonde menu** selection to access the sonde **Calibrate** menu. Once the menu has been activated, use the arrow keys to highlight a sensor for calibration and follow the instructions on the screen. Use the keypad to enter numeric values associated with the calibration standards and press **Enter** to confirm your input. View the data from each calibration standard in real-time and then highlight the **Calibrate** selection in the upper frame. When the output is stable, press **Enter** to confirm the calibration point. Then highlight **Continue** and press **Enter** to either move to the next calibration point or to finalize the calibration. See the example in Section 3.4.2 above for a typical calibration procedure.

NOTE: To return a sensor calibration setup to its factory default setting, access any calibration routine for that particular sensor which asks for numeric input. However, instead of entering numbers, hold the **Enter** key down and press the **Escape** key. Highlight “yes” and press **Enter**. This protocol is the equivalent of entering the command “uncal” from a computer keyboard.

3.4.3.5 Changing the sonde Sensor setup

Use the **650 Sonde menu** selection to access the sonde **Sensor** menu. Once the menu has been activated, use the arrow keys to highlight a sensor for activation/deactivation and press **Enter** to confirm your choice.

3.4.3.6 Changing the sonde Report setup

Use the **650 Sonde menu** selection to access the sonde **Report** menu. Once the menu has been activated, use the arrow keys to highlight a sensor for activation/deactivation and press **Enter** to confirm your choice. See the example in Section 3.4.2 above.

3.4.3.7 Viewing data stored in the sonde

Utilize the **650 Sonde menu** selection to access the **File** menu of the sonde. Highlight the “View file” selection and press **Enter**. Select the file that you want to view. Choose **Proceed** and press **Enter** to view the entire file or select the portion of the data that you want to view and then select **Proceed** and press **Enter** to confirm your selection. After data has appeared on the screen, use the arrow keys to select the particular sensor data that you wish to view.

IMPORTANT: The sonde **Quick view file**, which is designed to show the last page of data of the last logged file when the sonde is interfaced to a PC is slightly different for the sonde/650 interface. Making this selection will indeed show data from the last logged file, but all data (not just the last page) will be displayed. It is still possible, however, to quickly view the last few logged data points which may be important in checking a sonde’s current performance in the field. To rapidly move to the end of the file (in either **View file** or **Quick view file**), press and HOLD the down arrow to accelerate the transition to the final data points. Then use the arrow keys to view the data of interest.

3.4.3.8 Configuring and setting the sonde clock

Utilize the **650 Sonde menu** selection to access the **System** menu of the sonde. Highlight the **Date & Time** selection and press **Enter**. Use the arrow keys to highlight the preferred date format and press **Enter** to confirm your selection. Activate/deactivate the **4-digit year** selection, as desired, using the **Enter** key to toggle between choices. Finally, set the date and time by highlighting the entries and inputting new values from the keypad.

3.4.3.9 Setting the sonde Autosleep configuration

As explained in Section 2 of the 6-series manual, the setup of the **Autosleep RS-232** function of the sonde should be governed by the following rules:

- Unattended sample studies/Remote deployments – Autosleep Active
- Discrete sample studies with user present – Autosleep Inactive

The rules are particularly important with regard to the method of dissolved oxygen calibration – automatic at the Unattended sample interval if Autosleep is Active; manually controlled by the user if Autosleep is inactive. See Section 2 of the 6-series manual for additional information on the Autosleep function.

To set the Autosleep function, utilize the 650 **Sonde menu** selection to access the **Advanced|Setup** menu of the sonde. Use the up/down arrow keys to highlight the **Autosleep RS232** selection and toggle the function on/off with the **Enter** key until it is correct for your application.

3.5 LOGGING DATA WITH THE 650

3.5.1 INTRODUCTION AND BASICS OF LOGGING

A primary function of the 650 is to facilitate the storage of field data from 6-series sonde sensors for later analysis. It is important to understand that sonde sensor data can be logged to two memory locations using a system consisting of a 650 interfaced with a sonde: (1) memory resident in the sonde and (2) memory resident in the 650 itself. Different applications may favor one logging choice over another. In addition, data can be logged either as single points (after the user has verified stabilization) or as a continuous data stream at a fixed sample interval. No matter where or how the user decides to log field data with a 650/sonde system, the 650 software plays the key role in controlling the process.

When setting up the 650/sonde system for your logging application, it is important to realize that the **650 Run** display, from which all logging is initiated can be activated by two methods. The first is to simply highlight the **Sonde run** selection from the 650 menu. The second is to use the **Sonde menu** command from the **650 Main menu** to enter the sonde menu structure and then to activate a **Discrete sample** study. Either of these methods can be used to log data to both the sonde and the 650. However, for most applications, the latter method (Run screen from sonde **Discrete sample**) should be used to activate logging to sonde memory with the sample interval between logged points in a continuous data stream set from the **Discrete sample** menu of the sonde. Likewise, the former method (direct activation of the **650 Run** display from the **Sonde run** command) should usually be used to activate logging to 650 memory with the sample interval set in the Logging setup menu of the 650.

NOTE: Logging to sonde memory may not be possible for some older version 600R, 600XL, and 6820 sondes that were purchased prior to September 1999.

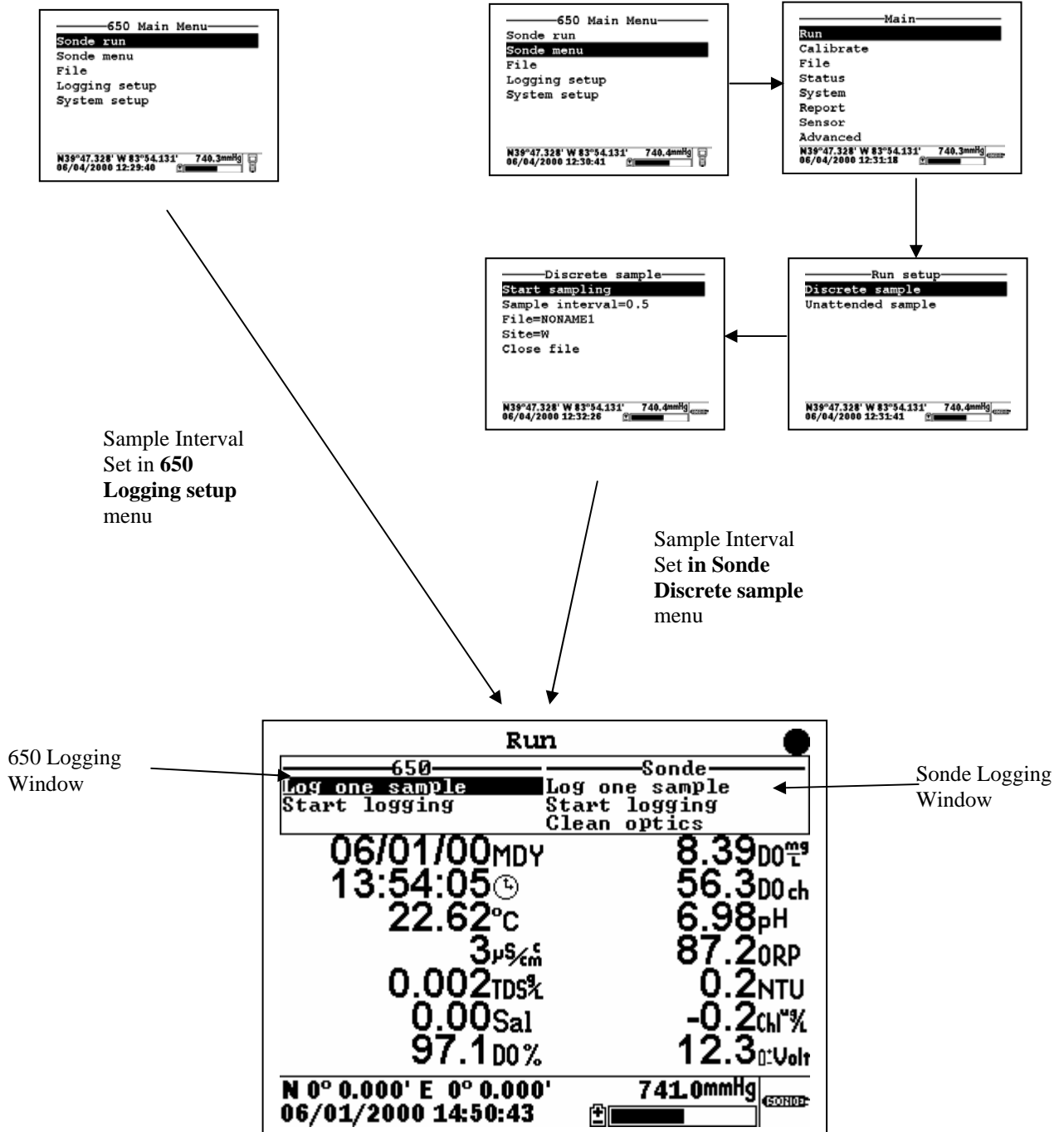

The user should also note the two windows in the upper portion of the display above, one designated “650” and the other “Sonde”. All logging, either to sonde or 650 memory is controlled from these windows. As indicated, data storage to the 650 is controlled from the upper left logging window. Storage to the sonde memory is controlled from the upper right logging window. The highlighting cursor associated with the logging windows can be moved within a particular window using the up/down arrows and toggled from window to window using the left/right arrows. Note also that, if your sonde contains an optical sensor, it is possible to activate the probe wiper prior to logging from the Sonde logging window.

While the following sections will show that the logging functions of the 650 have a high degree of flexibility and capability, from a basic point of view, logging with the 650 is simple:

- Decide if you want to log data continuously, and, if so, determine what sample interval between data points is appropriate for your study. If you will be logging to 650 memory, highlight the **Logging setup** selection from the 650 Main menu, then highlight the **Interval** selection and set the interval as desired. If you will be logging to sonde memory, select the **650 Sonde menu** and then **Run|Discrete sample** from the sonde menu. Set the sample interval and then activate the data display by selecting **Start sampling**.
- Select the memory (sonde or 650) in which you want to store your data by toggling between the logging windows.
- Highlight the logging method desired – “Log one sample” for a single logged point or “Start logging” to store a continuous data stream.
- Press **Enter** to activate the logging selection.
- To end the study if a continuous data stream was selected, press **Enter** with the highlight cursor on the **Stop logging** command or press the **Escape** key.

Sections 3.5.2 and 3.5.3 below provide details and real-life examples of logging data to sonde memory and to 650 memory, respectively, using the 650 as the interface.

3.5.2 LOGGING DATA TO SONDE MEMORY

3.5.2.1 INTRODUCTION

All YSI 6-series sondes sold since September 1999 have memory present on their internal PCBs. In addition, all 600XLM, 6920, and 6600 sondes have internal memory, regardless of the date of purchase. Interface of these sondes to a 650 allows the user to easily store data (either a single point or a continuous stream) to the sonde memory. If a continuous stream of data is desired, the interval between the stored points is controlled by the **Sample interval** in the sonde’s **Discrete sample** function. The file name under which this data is stored and the site name associated with the file are also input in the **Discrete sample** function of the sonde using the 650 keypad as the input method. When logging to sonde memory, be sure to follow the instructions above with regard to entering the **650 Run** display either directly from the **650 Sonde run** menu or indirectly from the **650 Sonde menu** selection to control your sample interval.

The following examples show the setup and implementation of logging to sonde memory using the 650 as the interface device.

3.5.2.2 EXAMPLE 1 – SIMPLE SINGLE POINT LOGGING TO SONDE MEMORY

A user with a 600XL/650 system wants to store data electronically from a single site rather than writing down the information manually in the field.

To log this data point to the sonde memory, the user highlights the **Sonde run** selection in the **650 Main menu** and presses **Enter** to begin data display.

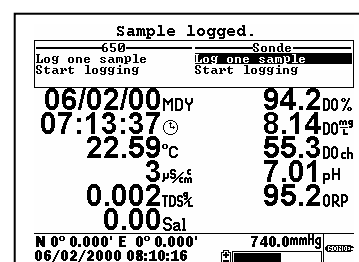
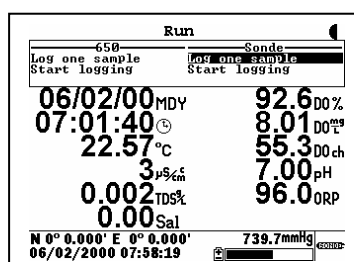

The user places the sonde in the water and watches the readings on the 650 display until they are stable. When stable, the **Log one sample** selection in the Sonde logging window (upper right) is highlighted as shown above and the **Enter** key is pressed. The header changes from “Run” to “Sample logged” to confirm that the data storage to sonde memory was successful and then returns automatically to the **Sonde run** display. The user turns the 650 off and returns to the office to retrieve the data.

The single data point is stored in the sonde memory under the automatically generated file name NONAME1. The file can be viewed by selecting **Sonde menu** from the 650 Main menu and pressing **Enter**.

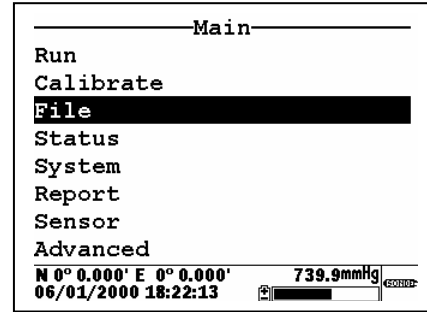
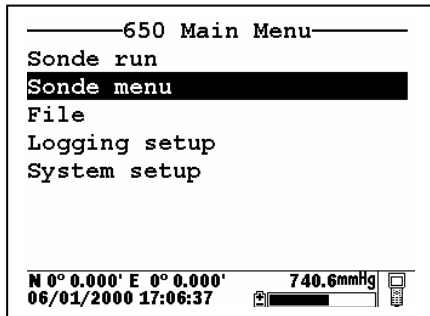

To view the data on return from the site, the user selects the sonde menu **File** selection, presses **Enter** to confirm the entry, and then highlights the **View file** selection and presses **Enter**. Following these instructions generates a display of the data that is stored in the sonde memory under the default name NONAME1. Use the right/left arrow keys to scroll horizontally to view all of the data.



NONAME1			
Date	Time	Temp	SpCond
m/d/y	hh:mm:ss	C	uS/cm
06/01/00	17:28:59	22.44	3

At the bottom of the display, it shows coordinates N 0° 0.000' E 0° 0.000', a pressure reading of 740.0mmHg, and the date/time 06/01/2000 18:26:59.

NONAME1			
TDS	Sal	DOsat	DO
g/L	ppt	%	mg/L
0.002	0.00	104.8	9.09

At the bottom of the display, it shows coordinates N 0° 0.000' E 0° 0.000', a pressure reading of 739.7mmHg, and the date/time 06/01/2000 18:34:08.

The user manually records the data from the site and turns the system off.

3.5.2.3 EXAMPLE 2 – CONTINUOUS LOGGING APPLICATION TO SONDE MEMORY

A user wants to carry out a vertical profile of a lake from 0 to 30 feet in order to detect the presence of a thermocline, and, if identified, to locate its position in the water column. The experiment will involve lowering a 6920 sonde in 1 foot increments until the bottom of the lake is detected, leaving the sonde at each depth for 3 minutes to allow the sensor readings to stabilize while logging data continuously. Thus, the user will generate data over a 90 minute time period (30 increments times 3 minutes per increment). If data were logged directly to sonde memory at the default 0.5 second sample interval, a very large data file containing 5400 data points would be generated, with little benefit gained from its size.

With this in mind, the user decides to increase the sample interval to 16 seconds, thus greatly reducing the amount of data in the file with no loss of real resolution. As explained above, the sample interval for logging to sonde memory is set in the Discrete sample menu of the sonde, and thus the user **MUST** activate the **650 Run** display indirectly using the **650 Sonde menu** selection as detailed above.

The user attaches the 6920 sonde to a 650. After turning on the 650, the user selects **Sonde menu** from the **650 Main menu** and presses **Enter** to display the **Main** sonde menu.

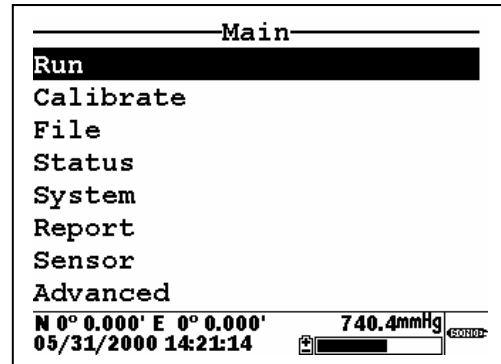
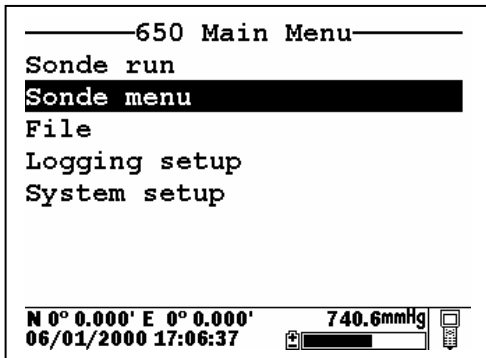

The user then selects **Run** from the sonde Main menu and **Discrete sample** from the **Run** menu, pressing **Enter** to confirm each selection.

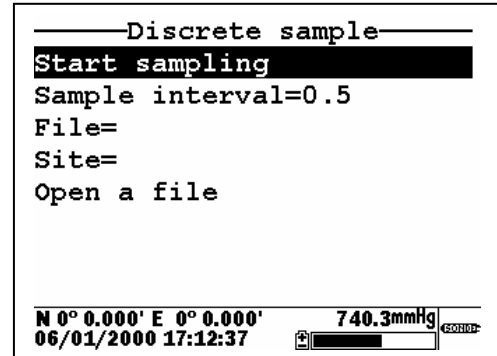
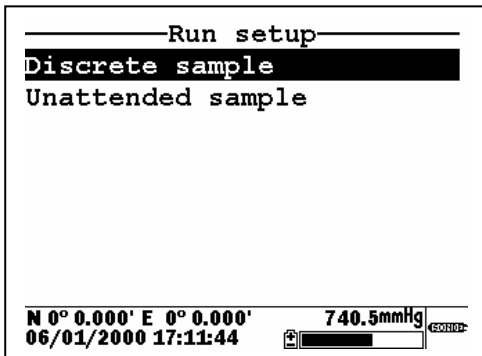

To set up the desired study parameters, the user uses the 650 keypad to change the Sample interval from 0.5 seconds to 16 seconds and inputs custom file (PROFILE1) and site (WEST LAKE) designations.

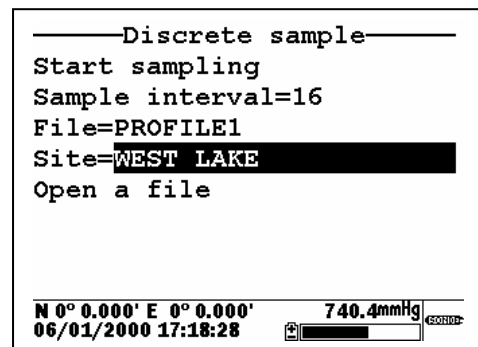
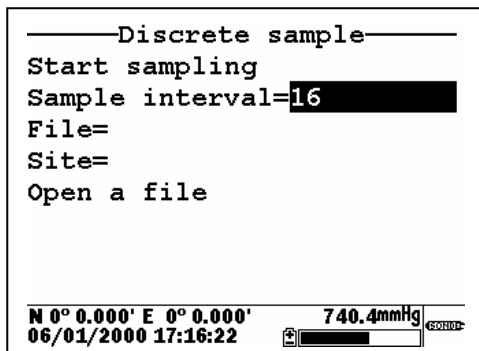

The user then highlights **Start sampling** and lowers the instrument into the water to begin the study. The data displayed on the screen is updated every 16 seconds. The user then highlights the **Start logging** selection in the sonde logging window in the upper right of the display and presses **Enter** to begin logging data to sonde memory. The message in the sonde logging window changes to **Stop logging**, indicating that logging has successfully been activated.

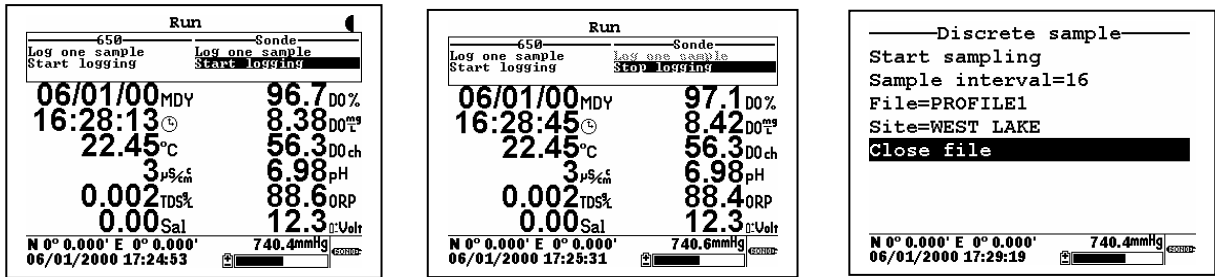

At the end of the 90 minute profile determination, the user either confirms the **Stop logging** command by pressing **Enter** or simply presses the **Escape** key to return to the sonde **Discrete sample** menu, highlights the **Close file** selection, and confirms the file closing by pressing **Enter**.

The profile data taken at a 16 second sample interval is now stored in the sonde memory under the file name PROFILE1. It can be viewed on the 650 display and/or uploaded to the 650 memory or directly to a PC by accessing the sonde **File** menu.

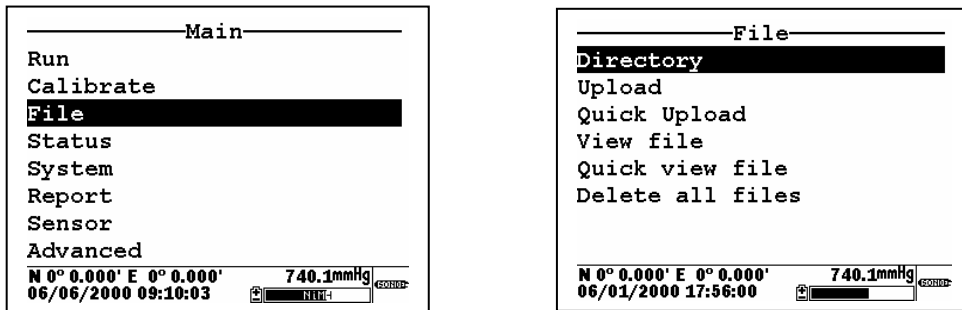

3.5.2.4 SONDES WITHOUT MEMORY

If your sonde is a 600R, 600XL, or 6820 purchased prior to September 1999, it may contain a circuit board that does not have memory. With sondes of this type, you will not be able to log data to the sonde – only to the 650 as detailed in the following section. With these no-memory sondes attached to your 650, the **Run** display will show a blank Sonde logging window as shown below.

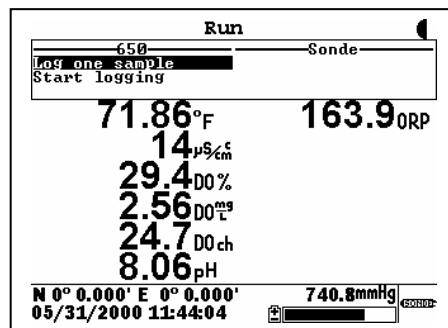

3.5.3 LOGGING DATA TO 650 MEMORY

3.5.3.1 INTRODUCTION

Even if the sonde in your 650/sonde system has its own memory, it may be more convenient for you to log data directly to the 650 memory simply because you eliminate the need to upload the data after logging, i.e., it will already be resident in 650 memory. In addition, logging directly to 650 memory allows you to log GPS and barometric pressure readings along with sonde sensor data. Barometer and GPS data cannot be logged to sonde memory. Finally, the file/site list capability associated with the 650 is more powerful than that of the sonde, allowing you to log data from several sites to a single file. If these applications are important to you, then it is likely that logging directly to 650 memory should be your first choice. Naturally, if your sonde is a 600R, 600XL, or 6820 with no memory (pre-1999), then you will be REQUIRED to log your sonde data directly to the 650.

Before proceeding in this section, be sure that you review Section 3.5.1 above which describes the basics of logging with a 650 (either to sonde or to 650 memory).

The following sections will provide details and examples of the flexibility of logging sonde data to 650 memory. The distinction between (a) simple occasional logging with file and site names entered at the logging site and (b) logging to a more sophisticated file structure where file parameters are entered into a site list prior to going to the field will be described.

3.5.3.2 SIMPLE LOGGING TO 650 MEMORY

The term “simple logging” to 650 memory refers to the method of defining file and site names for the study. In applications of this type, the user inputs new file and site (optional) names for each study at the time the data is logged.

IMPORTANT: The **Use site list** selection in the **650 Logging setup** menu should be **INACTIVE** for the example below which demonstrates simple logging.

A user with a 600XL/650 system wants to store a continuous stream of data electronically for a single site at a sample interval of 10 seconds between data points. Note that this is a similar example to that in 3.5.2.2 above, except that the logging is to 650, rather than sonde, memory and a data stream, rather than a single point, will be logged.

The first step in this application is to make certain that the sample interval is set correctly for the logging study. The factory default sample interval of 1 second will therefore need to be changed to 10 seconds.

To set the sample interval, highlight the **Logging setup** entry in the **650 Main menu** and press Enter.

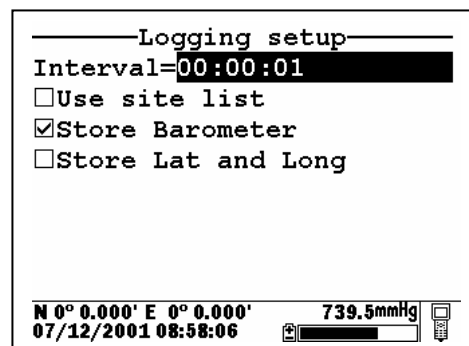
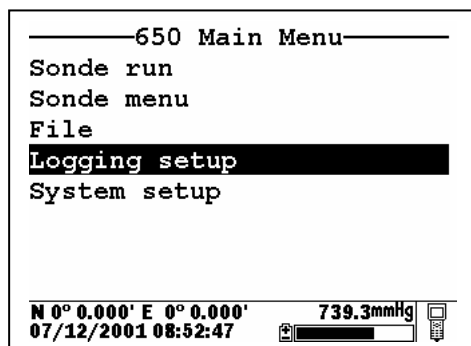

Press Enter at the highlighted **Interval** selection and use the arrow keys to scroll to the right and change the interval from 1 second to 10 seconds. Confirm the selection by pressing **Enter** and then press **Esc** to return to the **650 Main menu**.

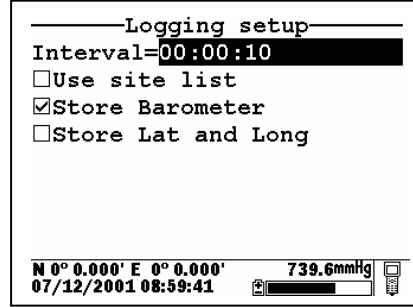
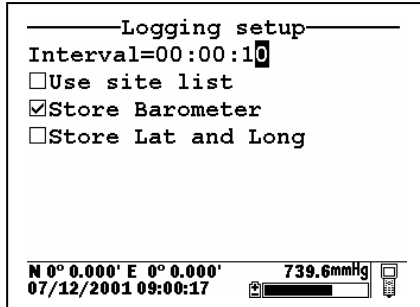

Once the sample interval is set correctly in the **650 Logging setup** menu, the user simply highlights the **Sonde run** selection in the **650 Main menu** and presses **Enter** to begin data display.

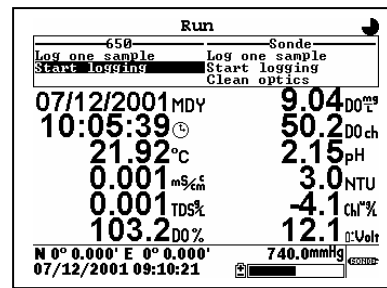
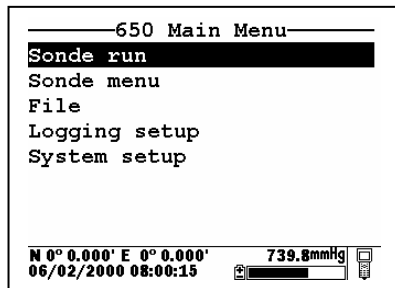

The user places the sonde in the water and then highlights the **Start logging** selection in the 650 logging window (upper left) and presses **Enter**. The user is then prompted to enter a **Filename and Site description** for the study as shown below.

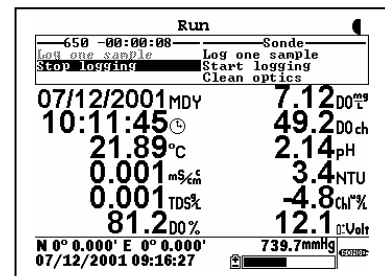
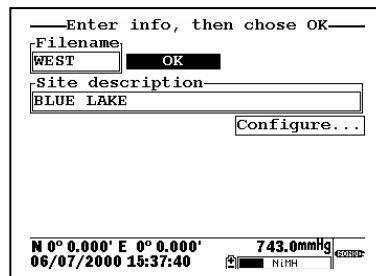
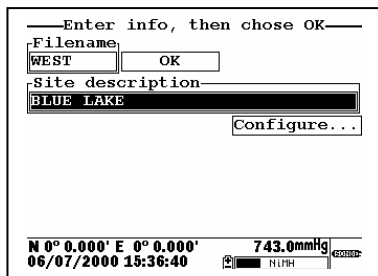
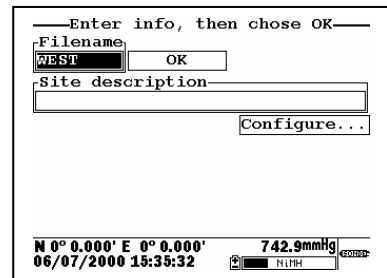
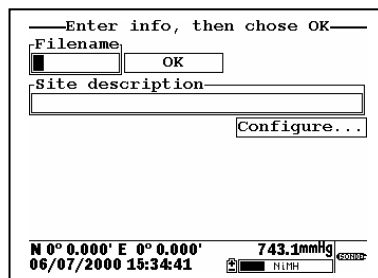
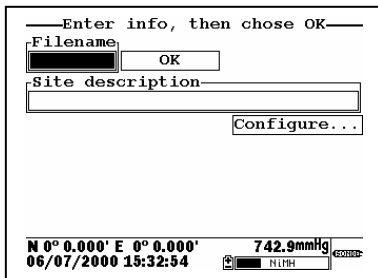

Using the arrow keys, the **Filename** window is highlighted, the user presses the **Enter** key and then inputs the file name (in this case, WEST) from the keypad as shown above. A site name (BLUE LAKE) is then entered from the keypad by highlighting the **Site description** window and proceeding as for the **File** name. Pressing **Enter** confirms the **Site** entry. The user then highlights the **OK** window and presses **Enter** to log the point. The header of the 650 logging windows changes to **Stop logging** to confirm that the data storage to 650 memory is active and a countdown timer appears at the top of the display to show the exact moment a point is logged to 650 memory. When the study is complete, the user highlights the **Stop logging** selection and presses **Enter** to terminate logging.

NOTE: For ultimate simplicity, it was not necessary to enter either a file or a site name in the above application. If the **OK** window had been highlighted immediately and **Enter** pressed, a point will be logged to a file in the 650 memory under the designation NONAME1. It is also possible to input a custom file name, but not enter a site name and then log the point.

The stream of data is stored in the 650 memory under the file name WEST that was input by the user. The file can be viewed by selecting **File** from the 650 Main menu and pressing **Enter**. Then highlight the **View file** selection and then the selected file (WEST), pressing **Enter** after each entry. The data in the file will be displayed as shown below. Use the arrow keys to scroll horizontally in order to view all of the data.

650 Main Menu		650 File		WEST.dat		
Sonde run		Directory		Date	Time	Temp
Sonde menu		Upload to PC		m/d/y	hh:mm:ss	C
File		View file		07/12/2001	09:16:55	21.92
Logging setup		File memory		07/12/2001	09:16:05	21.90
System setup		Delete all files		07/12/2001	09:16:15	21.90
				07/12/2001	09:16:25	21.89
				07/12/2001	09:16:35	21.89
				07/12/2001	09:16:45	21.89
				07/12/2001	09:16:55	21.89
				07/12/2001	09:17:05	21.89
				07/12/2001	09:17:15	21.89
N 0° 0.000' E 0° 0.000' 742.6mmHg		N 0° 0.000' E 0° 0.000' 742.4mmHg		N 0° 0.000' E 0° 0.000' 739.8mmHg		
06/07/2000 16:30:35		06/07/2000 16:31:15		07/12/2001 09:30:40		

Note that, using these same basic guidelines, data could have been logged at another site on the same day with the user inputting a different site designation (file name and site name) in the field. Data could also have been logged single points or as a continuous data stream at each site simply by the choice of **Log single point** or **Start logging**, respectively, in the 650 Logging window.

Data can also be appended at later times to existing site designations. However, there is a limitation on this process: **the parameter setup during subsequent logging runs MUST be exactly the same as for the first entry.** For example, if you add a sonde parameter to the Report for the second logging run to a particular site, you will not be able to append this data to the existing file. If you logged Barometer or GPS readings to the initial file you will be required to maintain the logging of these files on subsequent logging runs. If your current parameter setup is different from the one used initially, a “Parameter Mismatch” screen similar to that shown below will appear when you try to log data to the old site designation. The screen should help in pinpointing the change in your parameter setup that is causing the inability to append the file. In the example below, the old parameter setup is shown on the right of the screen and the new parameter setup is on the left. It is evident that the mismatch occurs in the third line where salinity from the new setup is “mismatched” with “DO %” from the old setup. The screen thus shows that salinity has been added to the parameter list between the two logging studies and must be removed if the original file is to be appended with further data.

filename:1TEF
Parameter mismatch
Temp C = Temp C
SpCond uS/cm = SpCond
uS/cm
Sal ppt != DOsat %
DOsat % != pH
OK
N 0° 0.000' E 0° 0.000'
08/20/2001 17:42:48

3.5.3.3 LOGGING TO 650 MEMORY WITH A SITE LIST

In the example above, you learned how to log data to 650 memory that had file and site designations input to the logger at the time that the data was logged in the field. It is also possible, and in most cases more convenient, to place file and site designations into the 650 memory in the office or laboratory before moving to field for logging studies. This is particularly true if you are aware of the sites at which you will be determining water quality data and/or which you will be visiting on a regular basis. The following section describes how to set up site lists which contain entries designated “Site Designations” that will be instantly available to the user in the field to facilitate the logging of data in the field with pre-established naming of files and sites. There are two kinds of **Site Designations** available for use in Site lists:

- **Site Designations** associated with applications where data from a single site is always logged to a single file. This type is referred to as a “Single-Site Designation” and is characterized by two parameters – a file name and a site name. Files logged to 650 memory under a **Single-Site Designations** will be characterized primarily by the file name, but will also have the Site name attached, so that it is viewable in either the **650 File directory** or in EcoWatch for Windows after upload to a PC
- **Site Designations** associated with applications where data from multiple sites are logged to a single file. This type is referred to as a “Multi-site Designation” and is characterized by three parameters – a file name, a site name, and a site number. Files logged to 650 memory under **Multi-site Designations** are characterized by a file name, but not a site name, since multiple sites are involved. However, each data point has a Site Number attached to it so that the user can easily determine the sampling site when viewing the data from the **650 File** menu or processing the data in EcoWatch for Windows after upload to a PC.

When reading the following section on the use of the **650 Site list**, remember that a **Site List** is a compilation of individual entries called **Site Designations**. **Single-Site Designations** are used when the data from a particular location is always logged to the same single file. A **Single-Site Designation** is characterized by a unique file name. **Multi-Site Designations** are used when data from several locations are logged to a single file. For **Multi-site Designations**, there will be a single **File Name** with multiple **Site Names** and **Site Numbers**. The following displays show examples of **Single** and **Multi-Site Designations**.

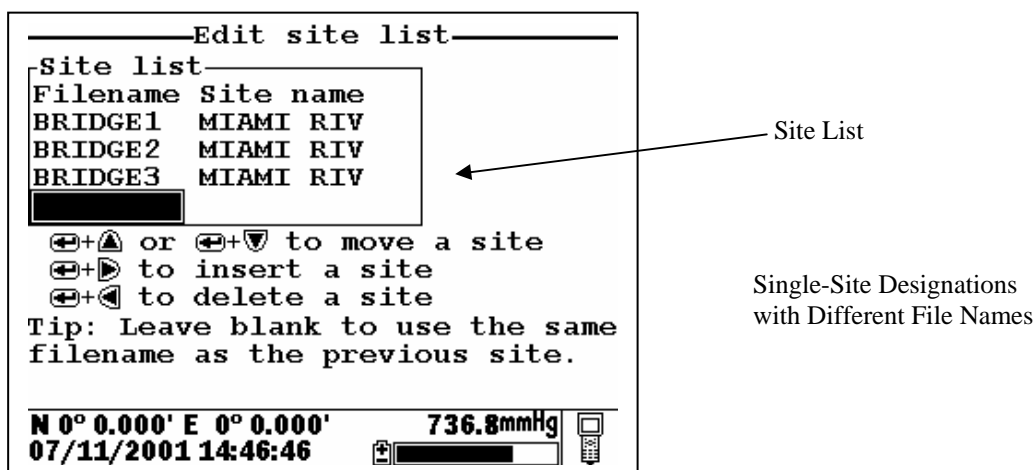

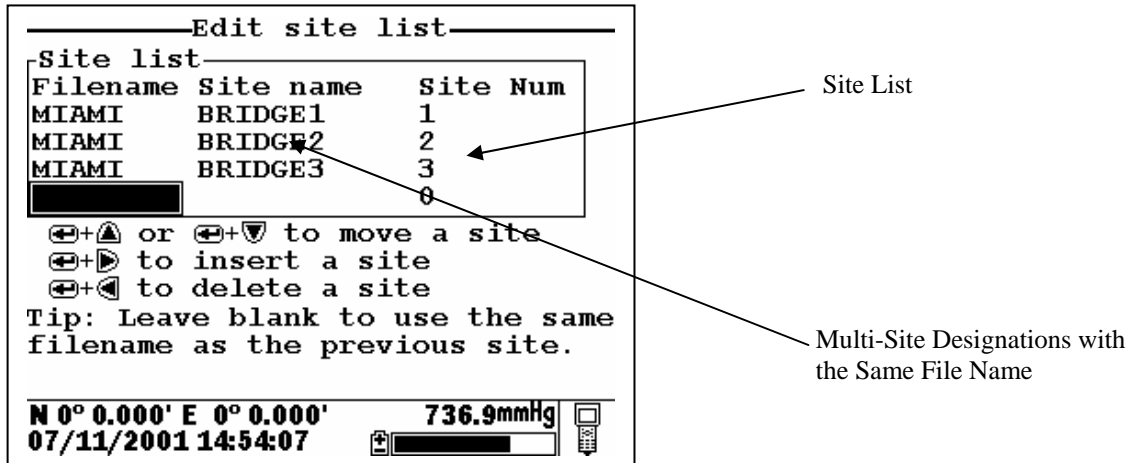

Note that Site lists containing Single Site Designations are usually input with the designation Store Site Number INACTIVE in the 650 Logging setup menu. Thus, no site numbers appear in the first Site list example. Conversely, Site lists containing Multi-Site Designations MUST be input with the Store Site Number selection ACTIVE as shown in the second example.

As noted above, establishment of either of these two types of Site Designations that are stored in 650 memory in a Site List will allow you to log field data to the 650 memory without entering file/site information from the 650 keypad in the field at each site. You will easily be able to access previously entered Site Designation information from this the Site List at each field site and thus simplify your record keeping and logging procedures. To utilize the full capability of the 650 logging system, you will need to understand how to set up and use these two types of Site Designations, particularly if you are performing multiple or replicate logging studies at various field sites. The following discussion and examples should help you understand how to set up site lists for various applications.

LOGGING OF DATA TO 650 MEMORY FROM SINGLE SITES TO SINGLE FILES – USE OF SINGLE-SITE DESIGNATIONS IN A SITE LIST

The setup and use of Single-Site Designations will be provided in the following application example: Water quality data needs to be collected for two sites at the West and East ends of a lake (Blue Lake) at various time intervals for 30 days. The environmental scientists want all of the data for each site to be in a separate data file that can be reported from EcoWatch for Windows or from a spreadsheet. The key to this application is that each physical location will need to be characterized by a different File Name in the Site Designation.

To establish a site list in the 650 memory for this application, highlight the Logging setup selection in the 650 Main menu and press Enter. The following screen will appear. Make certain that the selection Use Site list is active to display the full capability of the Logging setup as shown below. To set up a list with Single-Site Designations the selection Store Site number should be INACTIVE (as shown below) before proceeding.

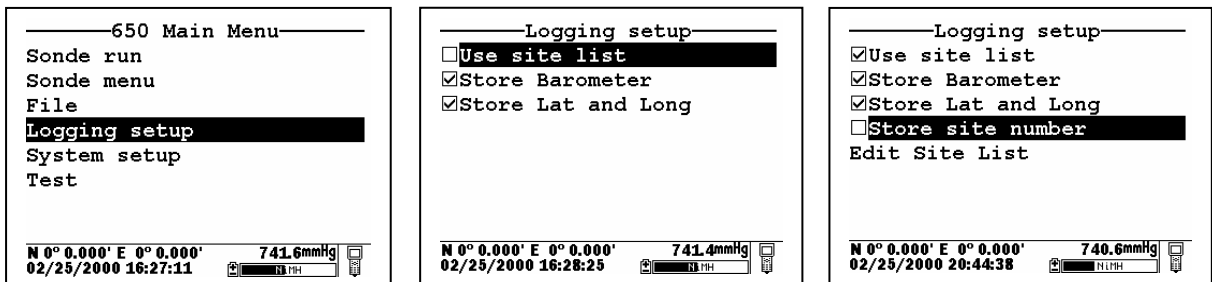

Note also that if you have purchased a 650 without the barometer option, the selection **Store barometer** will not be present. Decide whether or not you want to store GPS and barometer information with your data file and activate/deactivate the **Store Lat and Long** and **Store Barometer** selections appropriately. Leaving these selections active will occupy memory in the 650 during logging and this factor may be a consideration if you have purchased a 650 with “Low” memory and you do not really require this information in your file. Once these selections have been made, highlight the **Edit site list** selection and press **Enter** to display the screen below. Note that you can use the left/right arrows to scroll between the **Filename** and **Site name** selections and that tips about the meaning of these terms is provided at the bottom of the display depending on the position of the cursor.

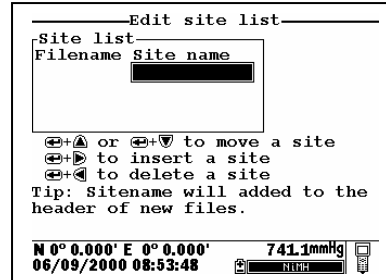
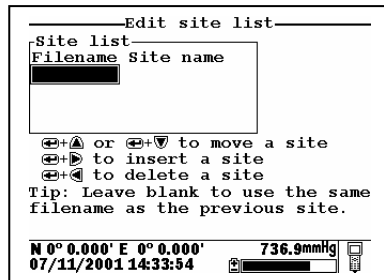

To make **Site list** entries for this application, begin by highlighting the **Filename** position, pressing **Enter** and inputting the file name (WEST, in this case). Press **Enter** to confirm the entry and the cursor will automatically move to the right for the entry of a **Site name**. Enter BLUE LAKE for the site and press **Enter** to confirm the entry. The cursor will move automatically to the next **Filename** entry position. Now enter EAST for the file name and BLUE LAKE for the site name, pressing **Enter** after each entry to confirm. Your site list should appear like that in the following display.

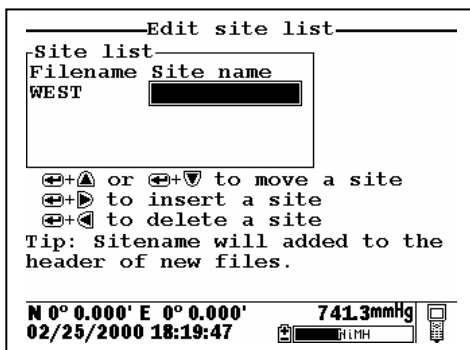

You have now established a site list that will be available in the field for logging of data to two files on BLUE LAKE -- EAST and WEST. To use this list, you need to first make certain that the entry **Use site list** is active in the **650 logging setup**. Then travel to the first location, identified by the **Filename WEST**, activate the **650 Run** display, and then select either a continuous data stream (**Start logging**) or a single data entry (**Log single point**) from the 650 logging window.

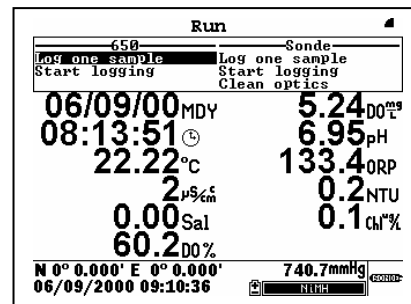

Then press **Enter**. When the logging prompt is activated, the site list will automatically appear on the display and be available for use in your study as shown below. First highlight the WEST file (since you are at that location) and press **Enter** to log data to the 650 memory. An indication that the logging was successful will appear in the 650 logging window. Then move to the next location (EAST), activate the 650 logging function, and repeat the logging process, but this time highlighting the EAST Filename entry.

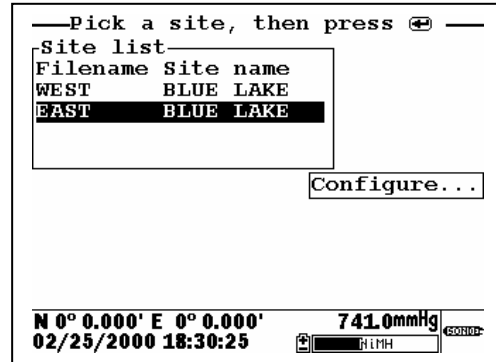
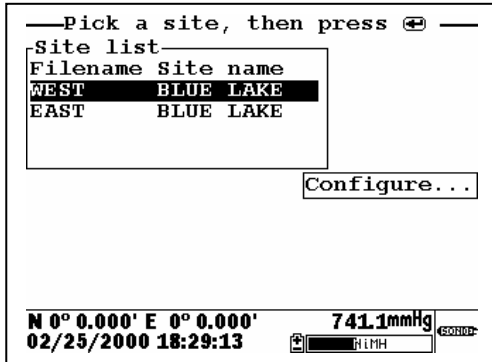

NOTE: If you want to return to the **Edit site list** display for changes before logging, use the **RIGHT ARROW KEY** to highlight the **Configure** selection and press **Enter**. The up/down arrows will only scroll within the Site list.

The data from the two locations has been logged to the selected files that can be either viewed manually using the 650 **View file** menu or uploaded to EcoWatch for Windows from the **650 File** menu. This means that all data for the West and East sites are located in separate files identified by the **File names** WEST and EAST as shown in the 650 File Directory below.

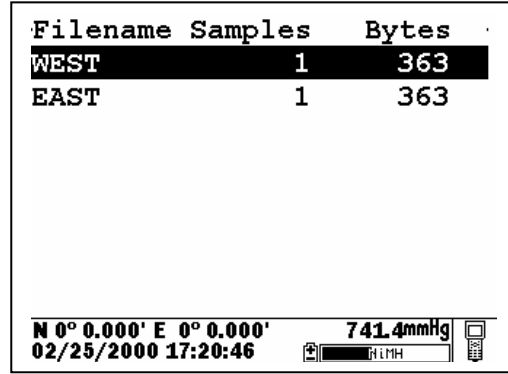
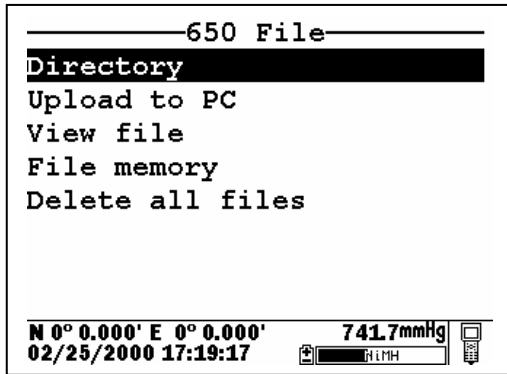

Details of the files (shown by pressing **Enter** when the File is highlighted in **Directory**) are shown below. Note that the site name (BLUE LAKE) is listed in the file since the data was logged using **Single-Site Designations**.

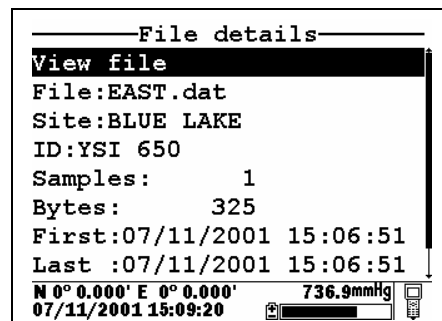
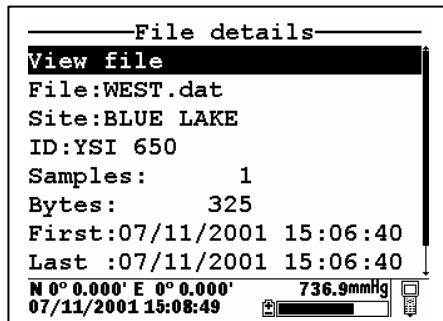

These files will remain “open” in 650 memory so that you can return to each location at a future time and log more data to the file designations WEST and EAST (but see note below). The key for this **Site list** setup is that all data logged will be stored in a separate file for each location (WEST and EAST) which were designated as file names at the site BLUE LAKE.

NOTE CAREFULLY: As described above for non-site list files, there is a limitation on appending data to existing files: the parameter setup during subsequent logging runs **MUST** be exactly the same as for the first entry. For example, if you add a sonde parameter to the Report for the second logging run to a particular site, you will not be able to append this data to the existing file. If you logged Barometer or GPS readings to the initial file you will be required to maintain the logging of these files on subsequent logging runs. If your current parameter setup is different from the one used initially, the **Site Designation** for that file will be “grayed-out” in the **Site list** and will not be available until you adjust your parameter setup. If you try to log data to the grayed-out file, you will be shown a “Parameter Mismatch” screen similar to that for non-site list files which will aid in diagnosing the differences in the parameter setup that is preventing the existing file from being appended with new data

LOGGING OF DATA FROM SEVERAL DIFFERENT SITES TO THE SAME FILE – USE OF A “MULTI-SITE” LIST

The setup and use of **Multi-Site Designations** will be provided in the following example which deals with a different approach to the application in the previous example on **Single-Site Designations**: Water quality data needs to be collected for two sites at the West and East ends of a lake (Blue Lake) at various time intervals for 30 days. In this case, the environmental scientists want all of the data in a single file for recording keeping convenience. The key to this application is that the **Site list** will need to contain **Multi-Site Designations** with the same **Filename**, but with different **Site names and Site numbers** to characterize each physical location.

To make Site list entries for this application, highlight the **Logging setup** selection in the 650 main menu and press **Enter**. The following screen will appear. As in the previous **Site list** setup, make certain that you have activated/deactivated the **Store barometer** and **Store Lat and Long** settings as appropriate for your application. The real key, however, in configuring the **Logging setup** display for use with a Multi-site list is that you **MUST** make certain that the selection **Store Site number** is **ACTIVE** (as shown below) before proceeding.

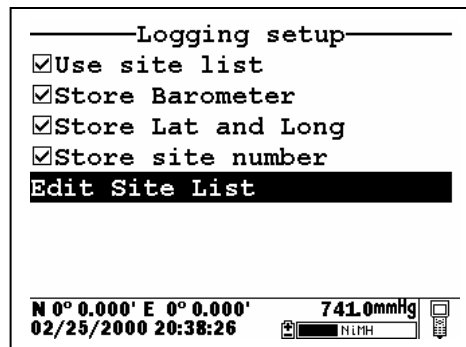
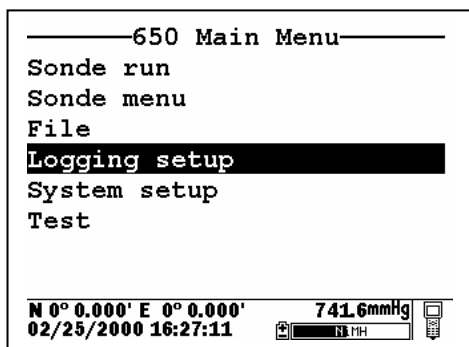

Then highlight the **Edit site list** selection and press **Enter** to display the following screen.

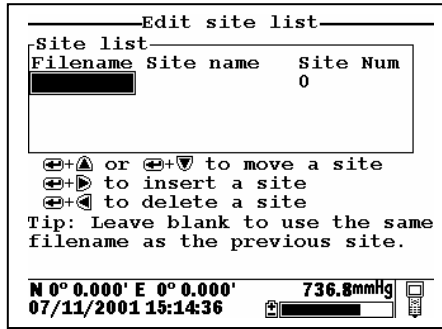

To generate a list of **Multi-Site Designations** for storing readings from various sites to the same file, establish two entries in the site list with the same file name (BLUELAKE). The entries will be differentiated by different **Site names** (WEST and EAST), and, more importantly, by different **Site Numbers** (1 for WEST and 2 for EAST) so that your site list appears as shown in display below.



You have now established a site list that will be available in the field for logging of data from two sites (WEST and EAST) to a single file (BLUELAKE). To use this list, you need to first make certain that the entry **Use site list** is active in the **650 logging** setup. Then travel to the WEST site, activate the **650 Run** display and then select either a continuous data stream (**Start logging**) or a single data entry (**Log single point**) from the 650 logging window, and press **Enter**. When the logging prompt is activated, the site list will automatically appear on the display and be available for use in your study as shown below. First highlight the entry with the WEST **Site name** (since your are at that location) and press **Enter** to log data to the 650 memory. An indication that the logging was successful will appear in the 650 logging window. Then move to the next location (EAST), activate the 650 logging function, and repeat the logging process, but this time highlighting the EAST **Site name** entry.

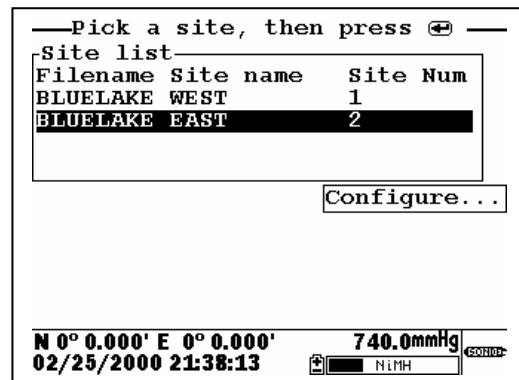
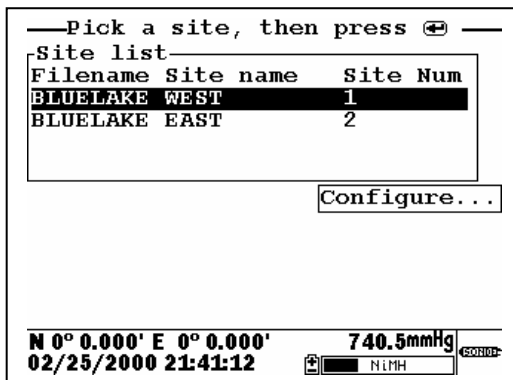

NOTE: If you want to return to the **Edit site list** display for changes before logging, use the **RIGHT ARROW KEY** to highlight the **Configure** selection and press **Enter**. The up/down arrows will only scroll within the **Site list**.

The data for two different sites has now been logged to the single file (BLUELAKE) that can be either viewed manually using the **650 View file** menu or uploaded to EcoWatch for Windows from the **650 File|Upload to PC** menu. The Site Number (“1” for the WEST site and “2” for the EAST site) will be stored with each data point and will be thus be available for identifying where the data was taken. The file BLUELAKE can be examined by use of the 650 **File** selection. In the 650 **File** menu, highlight **Directory** and press **Enter** as shown below. Then press **Enter** with the cursor on the BLUELAKE file to show the file details.

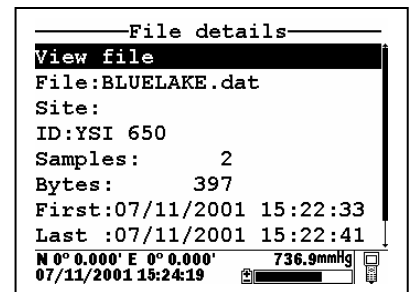
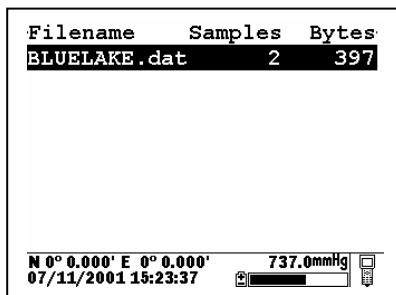
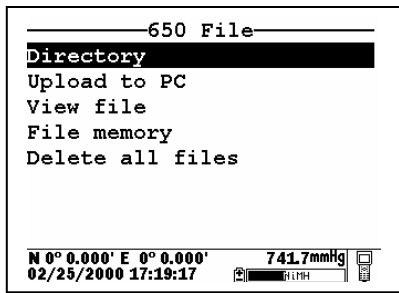

Note that there is **NO Site name** listed for the file BLUELAKE since data from more than on site was logged to it. Now highlight the **View file** selection and press **Enter** to display the data in BLUELAKE as shown below.

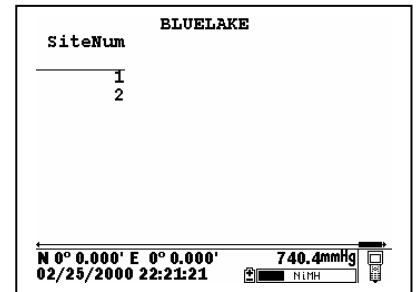
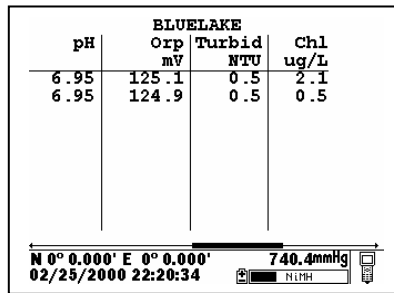
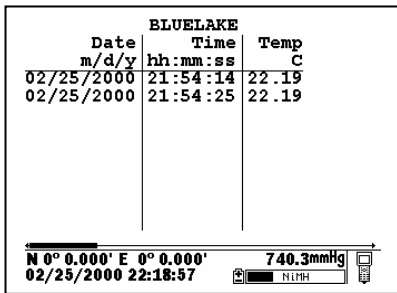

Note that the data from two sites is identified by the **Site Number** attached to each data record. To index these numbers to the appropriate locations, the user must consult the **Site list** by activating **Edit site list** from the **650 Logging setup** menu. The correlation between site names and numbers is found here, indicating that Site 1 is WEST and Site 2 is EAST.

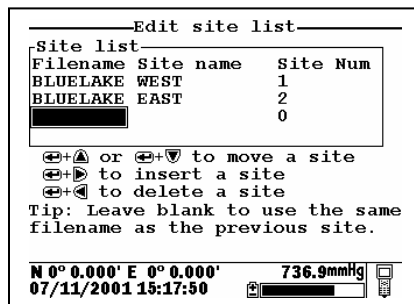

This file will remain in 650 memory so that you can return to each location at a future time and log more data to the **Site designations** WEST and EAST. The key for this site list setup is that all data logged will be stored in the same file (BLUELAKE) under different **Site Numbers** for each location (1 for WEST and 2 for EAST).

NOTE CAREFULLY: The same limitation noted above applies for appending the file BLUELAKE with additional data from these or other sites – the logging setup (sonde parameters, barometer, GPS) must be identical to that for the initially-stored data. If there has been a change in setup, the **Site Designation** will be “grayed-out” in the **Site List** indicating a parameter mismatch.

3.5.3.4 EDITING YOUR SITE LIST

The 650 software provides powerful tools for editing your site list. Actions such as inserting (adding) new entries, deleting existing entries, and moving entries within the list can be carried out easily from the keypad. Highlight the **Edit site list** entry in the **650 Logging setup** display and press **Enter** to show the following screen.

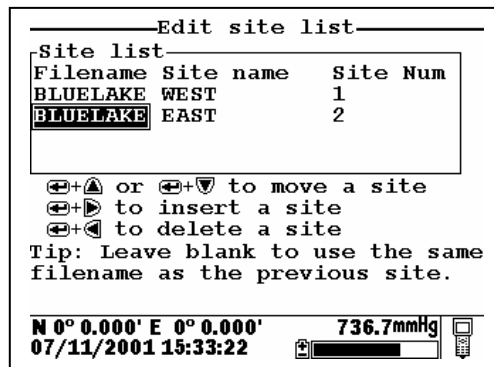

Note that the keystrokes for editing the site list are shown in the bottom of the Main Display. Thus, to insert (add) a file above the present cursor position, simply highlight the proper entry and press the **Right arrow** key while holding down the **Enter** key as shown in the following example. Note that two sites were inserted in the initial site list using this method.

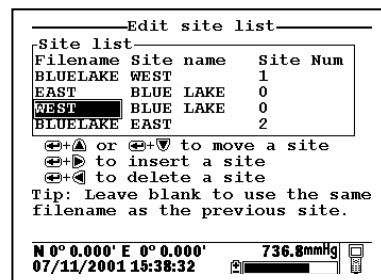
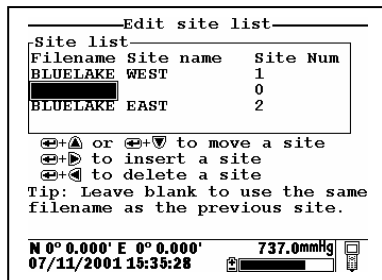

The two inserted entries can be moved either up or down in the list by highlighting them and pressing the **Up or Down arrow** key while holding down the **Enter** key or completely deleted by highlighting the entry and pressing the **Left arrow** key while holding down the **Enter** key as shown below.

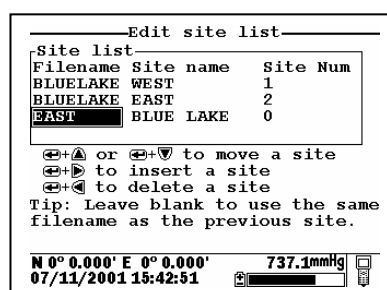
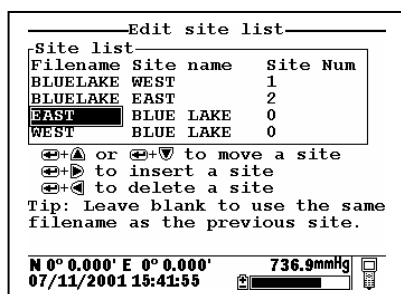

Finally, the user should be aware of a timesaving tip that is displayed when the **Filename** entry is highlighted. The tip allows much easier generation of **Multi-Site Designations** where the **Filename** is identical for several files. To “copy” the Filename from the previous file to a new entry below, simply highlight the new **Filename** block, press **Enter** and then enter site names and site numbers. The site list will show these blanks in the **Edit site list** mode as shown on the left below, but when the site list is accessed for logging studies the actual **Filename** will appear to avoid confusion. This is shown at the right below. Note that, by using this tip, two new sites have been easily added to the BLUELAKE Multi-site list with no need to enter “BLUELAKE” Filename for each new site.

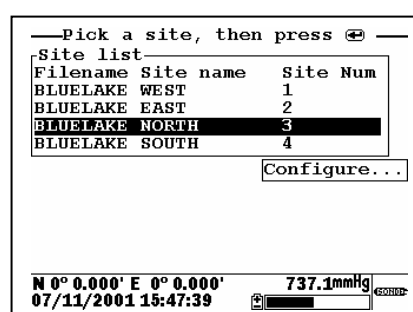
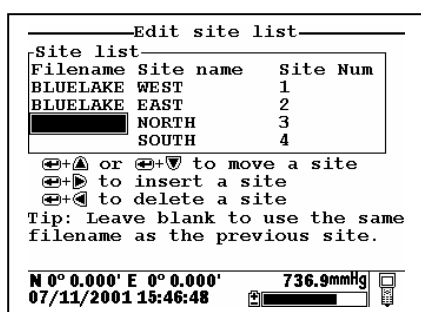

Remember that, when editing your Site list, you will have no effect on the actual files which were previously logged to 650 memory nor on the data in the files. See Section 3.6 below.

3.5.4 650 LOGGING – “CANS” AND “CAN'TS”

The use of the 650 to facilitate the storage of data from YSI 6-series sondes has been described in some detail in the sections above. Unfortunately, the high levels of capability and flexibility of the 650 logging function might also be viewed as complexity which, in turn, can confuse some users about how to employ the 650 in their particular application. This section is designed to help with any confusion that exists by listing what “can” be done with the 650 logging system and what “can’t” be done.

3.5.4.1 SUMMARY OF 650 LOGGING CAPABILITIES

WITH A 650/YSI SONDE SYSTEM, THE USER CAN:

- Log sonde sensor data to either sonde memory (if your sonde is so equipped) or 650 memory.
- Log data as either a single point or as a continuous data stream.
- Log data in both single point form and continuous stream form to the same file in 650 or sonde memory.

- Log continuous data stream data at long or short sample intervals to sonde memory, as long as the study is started from the Run menu of the sonde.
- Log continuous data stream data at long or short sample intervals up to 15 minutes to 650 memory using the **Sample interval** selection in the **Logging setup** menu of the 650.
- Log data from the 650 internal barometer to the memory of the 650.
- Log data from a user-supplied GPS unit to the memory of the 650, as long as the GPS unit is set up in NMEA format and has the proper cable.
- Log data with minimal keypad entry from the 650 display by using default file naming.
- Assign custom file and site names using the 650 keypad at the logging site.
- Set up custom site lists in the office or laboratory that are instantly available in the field to simply file/site management.
- Set up Site Designations that are characterized by a File Name and a Site Name for simple logging of data from a single site to a single file.
- Set up Site Designations that are characterized by a File Name, a Site Name, and a Site number which correlates with the Site name. These lists allow the logging of data from more than one site to the same file.
- Easily view data on the 650 display that has been stored to either sonde or 650 memory.
- Easily upload data that has been stored in either sonde or 650 memory to a PC for analysis using EcoWatch for Windows software from YSI.

3.5.4.2 SUMMARY OF 650 LOGGING LIMITATIONS

WITH A 650/YSI SONDE SYSTEM, THE USER CANNOT:

- Log GPS and/or barometer data to sonde memory.
- Log GPS and/or barometer to 650 memory without a sonde attached and the 650 in **Run** mode. See Sections 3.8.2 and 3.9.4 below.
- Log data to existing files in 650 memory if the data format does not EXACTLY match that of the data already in the file. Typical examples of this type of “file mismatch” include:
 - Attempting to append existing data files after changing the parameter list.
 - Attempting to append existing data containing a Site Number to a file that contains data without Site numbers.
 - Attempting to append existing data containing NO site number to a file that contains data with Site numbers.
 - Attempting to append existing files containing GPS and/or barometer data after deactivating the storage of these parameters in **Logging setup**.

- Delete individual files from 650 or sonde memory. The memory is “flash” and therefore all files must be deleted in order to regenerate the storage capacity.
- Enter more than 8 characters for a File name or more than 13 characters for a Site name.

3.6 MANAGING 650 FILES

3.6.1 INTRODUCTION

This section deals with the management of data that have been placed in 650 memory either through direct logging from your sonde or from the upload of data stored in sonde memory. A “file” by definition contains data and is distinct from the **Site Designations** in a **Site list** that are used to configure actual data files. For example, deleting an entry from the site list after points have been logged under this designation will have no effect on the actual logged data, i.e., the file itself will still be present in 650 memory. Conversely, deleting data files from the 650 memory will not delete the **Site Designations** from the **Site list**. The management of data stored in the 650 is controlled from the **650 File** command; the management of the list of file/site designations is controlled from the **Edit site list** command in the **650 Logging setup** menu as described in Section 3.5.3.4 above. Understanding this distinction will help the user avoid confusion in file and site list management.

It is also important to remember that, as described in Section 3.2.2 above, the memory of the 650 is “flash” and that, while this type of memory has many advantages, its use does impose two limitations on file management.

1. The files are listed in the order that they are logged to memory and this order cannot be changed.
2. It is not possible to delete individual files to free up memory. The only way to regenerate the 650 memory is to delete ALL files present, i.e., format the flash.

To proceed with the details of 650 File management, turn the instrument on, highlight the **File** entry in the **650 Main menu**, and press **Enter** to display the File commands as shown below.

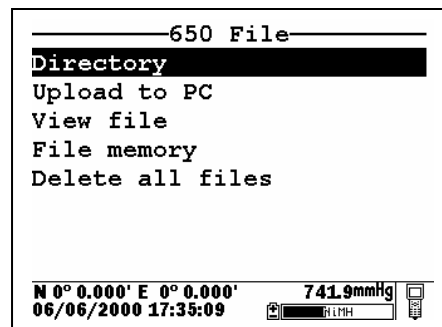
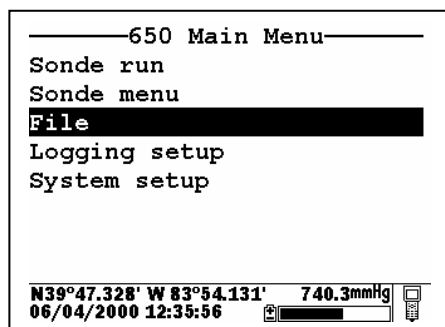

3.6.2 DIRECTORY

Use the arrow keys to highlight the **Directory** selection in the **650 File** menu and press **Enter** to display the list of files resident in the 650 memory.

Filename	Samples	Bytes
PROFILE1.dat	179	9047
DEPLOY1.dat	8	668

N 0° 0.000' E 0° 0.000'
07/12/2001 07:16:17 739.0mmHg

Note that the size of the file is shown in two different ways: (1) the number of samples (logged data points of several parameters) and (2) the total number of bytes of memory occupied by the file. Highlight the top file (PROFILE1) and press **Enter** to generate a display of the details of this file. Press **Escape** and then highlight the second file (DEPLOY1) and press **Enter** to again display information about the file.

File details	
File:	PROFILE1.dat
Site:	WEST LAKE
ID:	
Samples:	383
Bytes:	17496
First:	08/21/2001 07:34:37
Last :	08/21/2001 07:40:59
Interval:	Discrete
N 0° 0.000' E 0° 0.000'	
08/21/2001 08:18:52	

File details	
File:	DEPLOY1.dat
Site:	EAST LAKE
ID:	NotSet
Samples:	3
Bytes:	342
First:	08/21/2001 08:00:40
Last :	08/21/2001 08:10:40
Interval:	00:05:00
N 0° 0.000' E 0° 0.000'	
08/21/2001 08:22:26	

For both files, the file name, site name, file size and time of the first and last samples logged are shown. The information under **Interval** will identify whether the data were logged by manual control of the system (Discrete) or to the memory of a sonde set up in an **Unattended sampling** study. Only for **Unattended sampling** studies will the actual sample interval be displayed. When the Interval has the designation “Discrete”, the time between samples can be determined by viewing the data as described below.

3.6.3 UPLOAD TO PC

This frequently used command is used to transfer data files resident in the 650 memory (either logged directly or uploaded from sonde memory) to a PC that is running YSI EcoWatch for Windows software. Once transferred, the data can be custom configured, plotted, and reported in tabular form using this software package. The data can also be exported from EcoWatch in spreadsheet compatible form if the user prefers this method of data analysis and management. In order to carry out the upload of data files to your PC, you must first connect the 650 to a serial port of your computer via the 655174 PC Interface cable as shown in the following diagram:

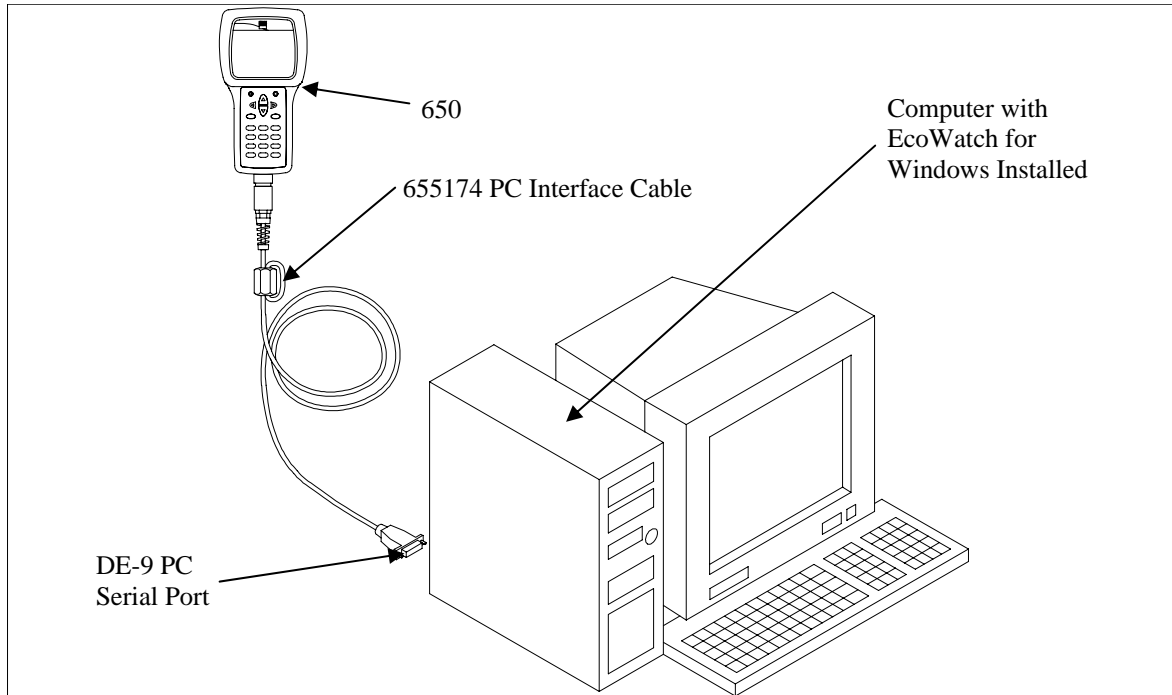

After the connection is made, run EcoWatch for Windows, click on the sonde icon in the upper toolbar, and set the Comm port number to match your interface. After this setup procedure, the following screen will be present on your PC monitor:

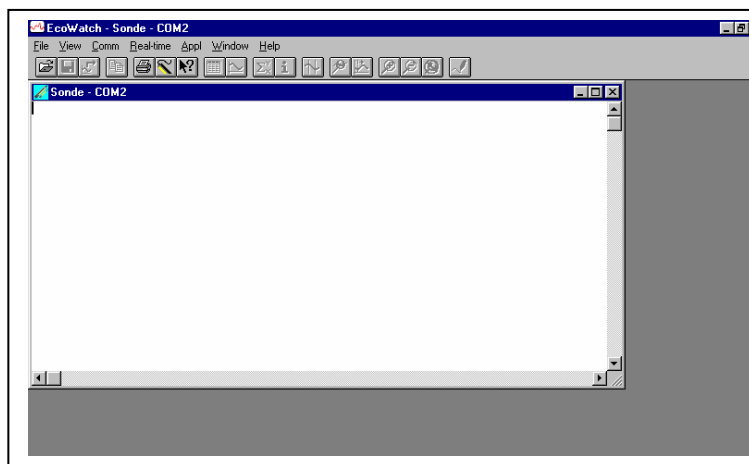

To transfer data from the 650 to your PC, highlight the **Upload to PC** selection in the 650 File menu and press **Enter** to view a list of the files. Highlight the file that you wish to transfer and press **Enter**. The 650 and PC displays will show the progress of the file transfer until completion.

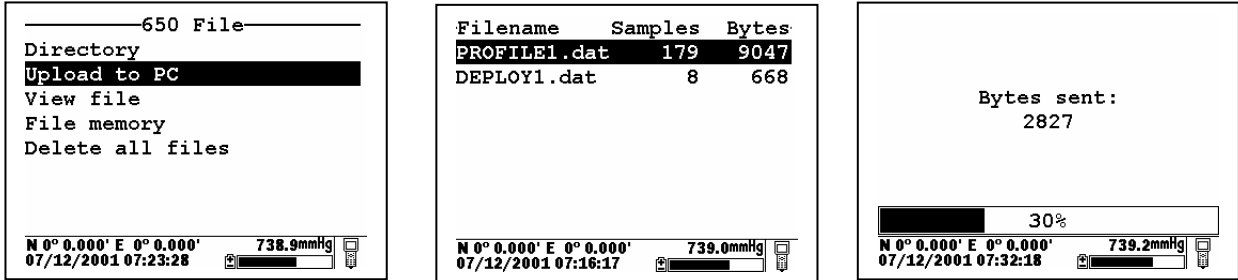

Note that there are three file types (with different extensions) in the above directory: (1) Files with .dat extensions which are data files logged to either sonde memory of 650 memory and which are in YSI PC6000 format; (2) Files with a .txt extension which are data files logged to sonde memory and then transferred to 650 memory in either ASCII or CDF format; and (3) Files with a .glp extension which are calibration records of either the sonde sensors or the 650 barometer. For files with a .dat or .txt extension, transfer to a PC using the **Upload to PC** command will proceed automatically and retain the file type that is present in 650 memory. For files with a .glp extension, an additional screen will appear on activating the transfer that gives a choice of binary, CDF, or ASCII for moving the file to the computer. You currently **MUST** use either the CDF or ASCII format for transfer so that the .glp file can be viewed in NotePad or other word processing program. The binary transfer option is for future YSI upgrades.

After transfer the file will be located in the C:\ECOWIN\DATA subdirectory of your PC hard drive.

3.6.4 VIEW FILE

The **View file** selection in the 650 File menu allows the user to examine the data in files logged or uploaded to 650 memory. Highlight the **View file** selection and press **Enter** to display a list of files present. Then highlight the file of interest and press **Enter** to view the data on the 650 display.

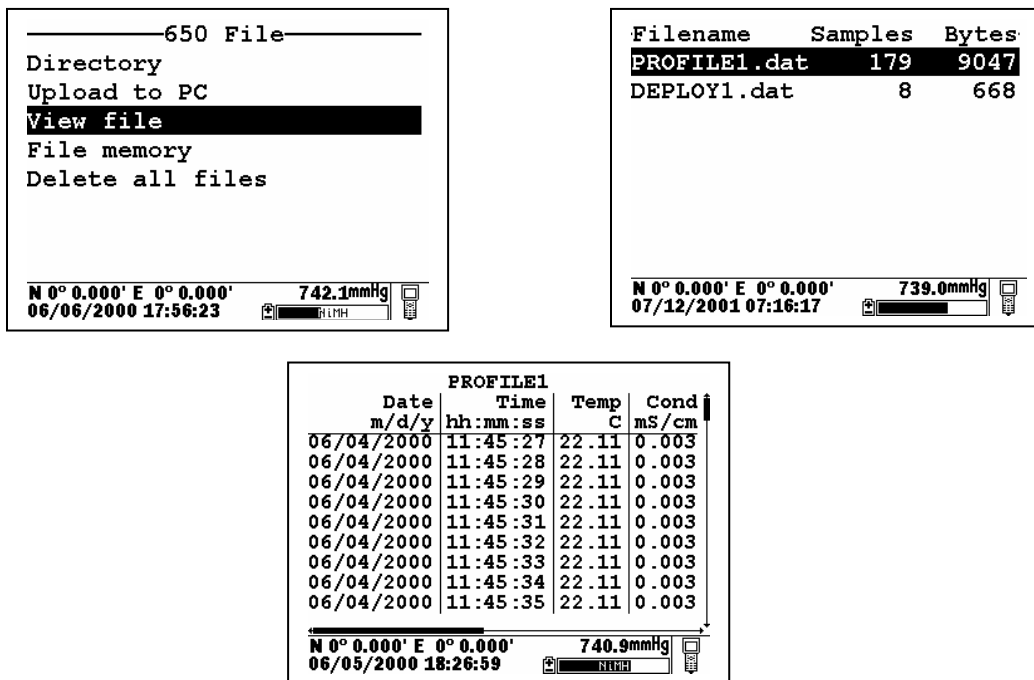



Use the arrow keys to scroll vertically to view more data points with regard to time or horizontally to view more sensor data within a particular data entry. The vertical and horizontal scroll bars identify your location within the data file.



3.6.5 FILE MEMORY

The **File memory** selection in the 650 **File menu** allows the user to get a complete picture of how the memory of the instrument is presently allocated. To view details of the allocation, highlight **File memory** and press **Enter** to display the following screen.

650 File	
Directory	
Upload to PC	
View file	
File memory	
Delete all files	

N 0° 0.000' E 0° 0.000'	741.8mmHg	
06/06/2000 17:59:02		

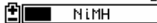
File bytes used	
Directory	6400
In files	512
In deleted files	0
Free	1565952
Total	1572864

N 0° 0.000' E 0° 0.000'	742.4mmHg	
06/07/2000 16:40:37		

The key number in the **File bytes used** display is the **Free** memory listing which can be used to determine when you need to format the 650 memory (“Delete all files” as described in the next section). The value under **Total** memory will reflect whether you purchased a 650 with high or low memory. The top three items in the display summarize the allocation of the used memory space. In the example above, 6400 bytes are used in defining the memory directory, 512 bytes are taken up with accessible files, and 0 bytes are taken up in “deleted” files. As described in Section 3.2.2 above, “deleted” files arise when the same file is uploaded from a sonde several times with the file “overwritten”.

There is a lot of information on the **File memory** display, but the number of greatest importance is the **Free** memory value.

3.6.6 DELETE ALL FILES

Use this selection to remove all files from the 650 memory. Remember that you cannot delete individual files from flash memory. Highlight the selection and press **Enter**. Use the arrow keys to confirm that you really want to delete all files and press **Enter**.

CAUTION: When you use this command, all data currently stored in the 650 memory will be irretrievably lost, so make certain that you have transferred all files of interest to your PC before carrying out the procedure. Note, however, that use of the **Delete all files** command will have no effect on any **Site Designations** which have been entered from the **Edit site list** selection.

3.7 UPLOADING DATA FROM SONDES

3.7.1 INTRODUCTION

A primary function of the 650 is to serve as an intermediate location for transfer of data stored in deployed 6-series sondes to a PC without bringing the sondes back to the base facility. In this application, the user connects the 650 to the sonde at the deployment site via a standard YSI field cable and, using the proper keypad commands, transfers the data stored in the sonde to the memory of the 650. The sonde is then redeployed without disturbing the study and the data transferred to a PC on return to the base facility.

3.7.2 UPLOAD PROCEDURE

After attachment of the sonde to the 650 with a YSI field cable, turn on the 650, highlight the **Sonde** menu selection and press **Enter** to display the Main sonde menu. Highlight the File selection and press **Enter**.

NOTE: The upload MUST be made from the File menu of the sonde, not the File menu of the 650.

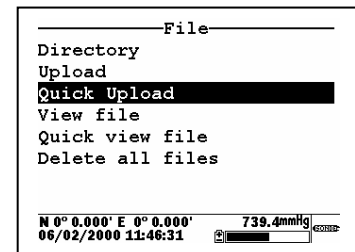
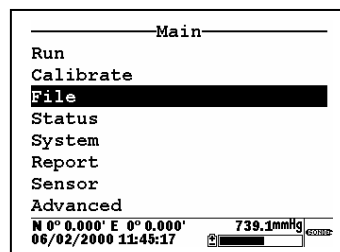
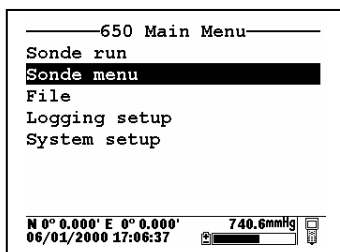

Select the **Upload** or **Quick upload** (last file) and press **Enter**. Then follow the instructions including selection of file format – YSI recommends the PC6000 format. Press **Enter** and the display will indicate that upload of data from sonde to 650 is in progress as shown below. When the upload is complete, the display will return to the **Sonde File** menu.

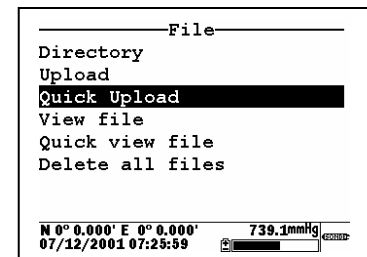
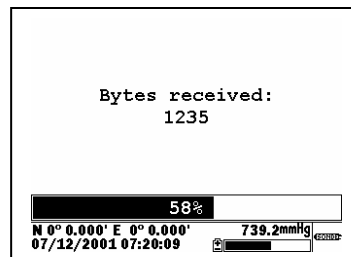
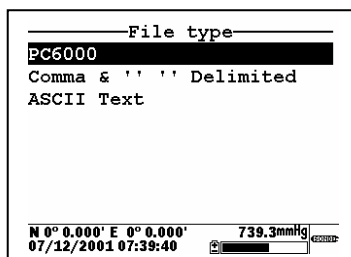

After the sonde file has been uploaded to the 650, the data is resident in the flash memory of both sonde and 650. Note that, if you choose to upload files from the sonde in CDF or ASCII format, the files will be characterized by a .txt extension in the 650 Directory and will NOT be viewable on the 650 display. To view the files, you must first transfer them from the 650 to your PC and then open them in a spreadsheet.

3.8 USING GPS WITH THE 650

3.8.1 SETTING UP THE GPS-650 INTERFACE

The 650 allows the user to display GPS readings of latitude and longitude from a commercially-available, user-supplied unit in the Status Bar of the 650 display. The interface of the GPS unit to the 650 is

accomplished via the 6115 GPS cable that can be purchased as an optional accessory. Using the 6115 cable, GPS readings can also be logged to the 650 memory along with sonde sensor readings taken at a particular geographical location, which can then be relocated for subsequent studies.

The use of the GPS interface is easy, but the user must configure the hardware and software of the GPS unit as follows before proceeding:

- Consult the user manual of the GPS unit and configure the instrument so that readings in the NMEA 0183 protocol are generated.
- Purchase from your GPS manufacturer a cable that connects at one end to the GPS unit and has at its other end a male DE-9 connector for interface with the YSI 6115 GPS cable.

Once these requirements are met, proceed according to the following instructions, consulting Figure 2 in Section 3.2.3 above for assistance:

- Connect the 6115 GPS cable to the 650 via the MS-8 connector.
- Connect the other MS-8 connector of the 6115 GPS cable to the MS-8 connector or your sonde cable.
- Attach the male DE-9 connector of the 6115 GPS cable to the mating female connector of your GPS unit.
- Turn on the 650 and make certain that appropriate GPS readings are displayed in the upper left corner of the Status Bar as shown in the following display.

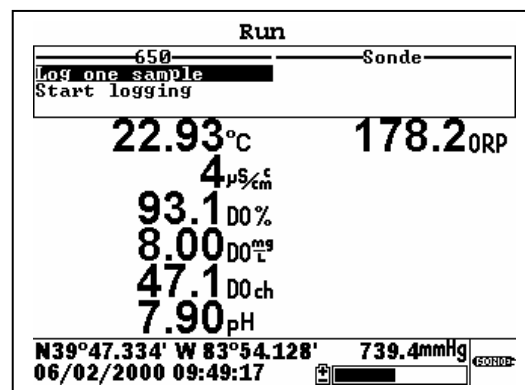

3.8.2 LOGGING GPS READINGS

To log latitude and longitude readings from a user-supplied GPS unit, the following conditions must be met:

- GPS readings can ONLY be logged to 650 memory – the system does NOT support logging to sonde memory.
- The GPS readings must be logged to 650 memory from the **650 Run** display along with sonde sensor readings. This means that you must have a sonde attached to your 650 via the 6115 cable in order to log GPS readings. Logging of GPS readings is not supported without sonde attachment even though these readings can be viewed in the Status Bar with no sonde attached.
- If you want to log the GPS readings to 650 memory along with sonde sensor readings at a particular location, you must make certain that the **Store Lat and Long** option is active in the **Logging setup** menu of the 650.

Once these conditions are met, follow the instructions in Section 3.5.3 above for logging of sonde sensor readings to 650 memory. The GPS readings will automatically be added to the file at the sample interval selected for the sonde readings.

GPS readings stored in 650 memory will remain as part of the sensor data file that can be viewed from the 650 display and/or uploaded with the data file for analysis in EcoWatch for Windows. Latitude and longitude are, however, displayed somewhat differently by the 650 and EcoWatch as noted below:

- For both display formats, the GPS are indexed relative to the point where the Greenwich Mean Time line crosses the equator.
- For the 650 Status Bar, readings are displayed in degrees and then decimal minutes relative to this point with actual “N” (north), “S” (south), “E” (east) and “W” (west) designations relative to the index point.
- When analyzing data in EcoWatch, the user will have the choice of two formats, decimal degrees (e.g., 47.5400 degrees) or degrees/decimal minutes (e.g., 47 ° 32.400’). For EcoWatch, alpha directional characters (“N”, “S”, “E”, and “W”) are NOT used. Instead, points north and east of the index point are designated as positive, while points south and west are designated as negative.

These criteria mean that the GPS coordinates of Yellow Springs, Ohio, USA are approximately 39 ° 47.33’ latitude and -83 ° 54.13’ longitude as read in EcoWatch, but N 39 ° 47.33’ W 83 ° 54.13’ as displayed by the 650.

3.9 USING THE 650 BAROMETER

3.9.1 PRINCIPLES OF OPERATION

The optional barometer operates on the strain-gauge principle and is located on the internal PCB of the 650. To make certain that the barometer is sensing true atmospheric pressure under conditions of temperature and pressure changes, the interior of the case is vented to the atmosphere with patches of material which are permeable to air, but impermeable to water. One of these patches is located in the rear section of the case and the other is attached to the battery lid. The patch on the case rear is not accessible to the user, but the one on the battery lid can be damaged by abuse. Be certain to identify the location of the patch on the interior of the battery lid and take care not to puncture it with sharp objects or to peel it away from the plastic. If you suspect that the venting patch on your battery lid has been damaged, make certain that you do not expose the 650 to water (either spraying or submersion). Then contact YSI Customer Service as soon as possible for advice.

The 650 barometer reads true barometric pressure and therefore is unlikely to agree with values from your local weather service which are usually corrected to sea level before being distributed. Note, however, that the primary purpose of the barometer is for use in calibrating your sonde dissolved oxygen sensor and the “true” value as shown in the 650 Status Bar is the required parameter for this procedure.

3.9.2 CALIBRATING THE BAROMETER

The 650 barometer is factory calibrated to provide accurate readings in the 500-800 mm Hg range which will be useful for dissolved oxygen calibration at most locations. This factory calibration should provide readings that are useful for dissolved oxygen calibration for many months with no user attention. However, if the user wishes to either increase the accuracy of the sensor in the local barometric pressure range or to compensate for

the small drift associated with any sensor, the 650 provides a single point calibration routine which is accessed in the **650 System setup** menu and is described in Section 3.3.5 above.

The critical factor in carrying out the single point calibration is the accuracy of the “standard” barometer that is used to determine the true barometric pressure. Common sources of this “standard” reading are high quality laboratory barometers (either mercury-based or electronic) and data from your local weather service. Laboratory barometer readings are usually “true” (uncorrected) values of air pressure and can be used “as is” for a standard as long as the system is known to be accurate. Weather service readings are usually not “true”, i.e., they are corrected to sea level, and therefore cannot be used until they are “uncorrected”. An approximate formula for this “uncorrection” (where the BP readings **MUST** be in mm Hg) is:

$$\text{True BP} = [\text{Corrected BP}] - [2.5 * (\text{Local Altitude}/100)]$$

Overall, the key point to remember in calibration of your barometer is to make certain that your “standard” reading is correct. If the “standard” is not accurate, you are likely to do more harm than good with your user-calibration.

3.9.3 CHANGING BAROMETER UNITS

The 650 offers the user a choice of six commonly used units of barometric pressure which can be displayed in the Status Bar. When received from the factory, the 650 will show values in mm Hg. If the user wants to change to other units, the selection is found in the **650 System setup** menu as shown below. Highlight the selection and press **Enter** to show the possible units. Then highlight the unit of choice and press **Enter** to activate it. The barometer reading in the Status Bar will automatically change to the newly selected unit.

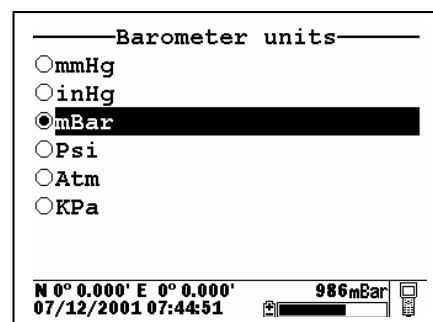
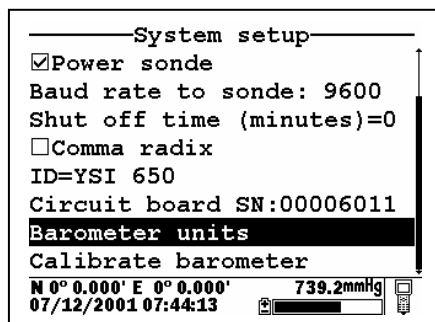

3.9.4 LOGGING BAROMETER READINGS

To log barometric pressure readings with the 650, the following conditions (similar to those above for logging GPS readings) must be met:

- Barometer readings can **ONLY** be logged to 650 memory – the system does **NOT** support logging to sonde memory.
- The barometer readings must be logged to 650 memory from the **650 Run** display along with sonde sensor readings. This means that you must have a sonde attached to your 650 in order to log barometer readings. Logging of barometer readings is not supported without sonde attachment even though these readings can be viewed in the Status Bar with no sonde attached.
- If you want to log barometer readings to 650 memory, you must make certain that the **Store Barometer** option is active in the **Logging setup** menu of the 650.

Once these conditions are met, follow the instructions in Section 3.5.3 above for logging of sonde sensor readings to 650 memory. The barometer readings will automatically be added to the file at the sample interval selected for the sonde readings.

Barometer readings stored in 650 memory will remain as part of the sensor data file that can be viewed from the 650 display and/or uploaded with the data file for analysis in EcoWatch for Windows. The barometric pressure readings are processed as a normal parameter by EcoWatch, with the user having the ability to change units from the EcoWatch menus. For example, data stored in 650 memory in units of mm Hg units can easily be converted to readings in mBar after upload.

3.10 UPGRADING 650 SOFTWARE

The 650 software can easily be upgraded from the YSI World Wide Web page (www.ysi.com). However, before accessing the Web page, the instrument should be prepared for upgrade by attaching the MS-8 end of the YSI 655174 PC Interface cable to the 650 and the DE-9 end of the 655174 to a serial port of a PC which has Internet access as shown below:

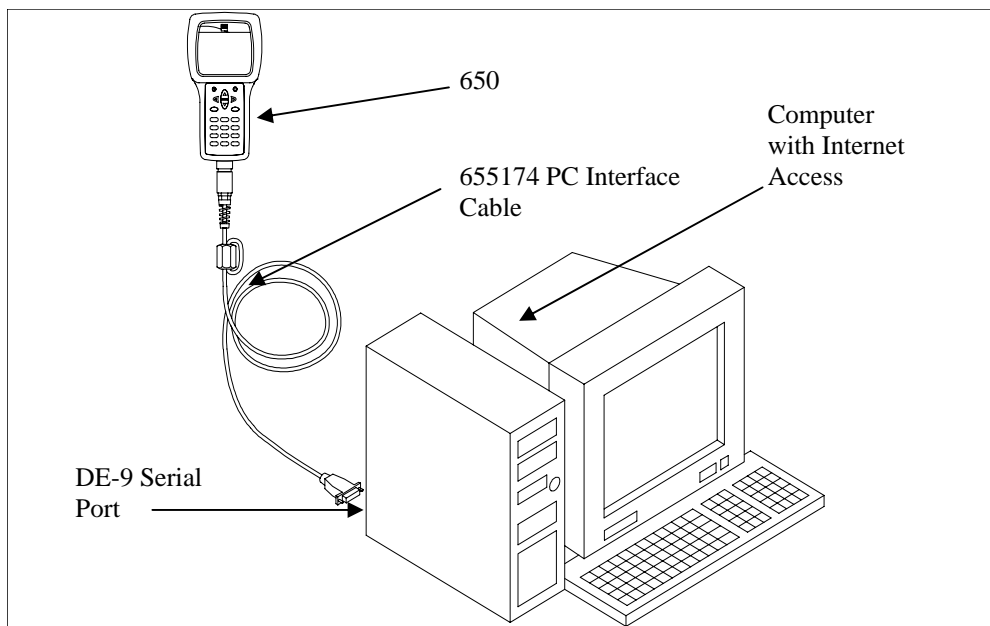

Once the setup is complete, access the YSI Web Page and locate the section on software upgrades. Select the 650 upgrade entry and follow the instructions provided on the Web Page. If you encounter difficulties in the upgrade procedure, contact YSI Customer Service for advice.

3.11 TROUBLESHOOTING

The following sections describes problems which you might encounter when using the 650 MDS and provides suggestions which might allow the user to overcome the symptom without additional assistance.

PROBLEM	POSSIBLE SOLUTION
No display is visible after pressing the on/off key.	If C cells are used, make certain that they are installed properly with regard to polarity and that good batteries are used. If a rechargeable battery pack is used, place the pack in the instrument and charge for 30 minutes.
No interaction with the sonde occurs when pressing Sonde run or Sonde menu from the 650 menu.	Make certain that (a) the cable is connected properly between sonde and 650 and (b) that Sonde power is activated in the 650 System setup menu.
Instrument software appears to be locked up as evidenced by no response to keypad entries or display not changing.	First, attempt to reset the instrument by simply turning off and then on again. If this fails, remove battery power from the instrument for 30 seconds and then reapply power. When using C cells, remove the battery lid and one of the batteries; when using the rechargeable battery pack, remove the pack completely from the instrument. After 30 seconds replace the battery or battery pack and check for instrument function.
Upload of files to 650 from sonde fails.	(1) Make sure that cable is connected properly to both 650 and sonde; (2) Make certain that you are accessing the upload routine from the <u>sonde File</u> menu and NOT from the <u>650 File</u> menu.
Upload of files from 650 to PC fails	1) Make sure that cable is connected properly to both 650 and PC; (2) Make certain that the proper Comm port is selected in EcoWatch for Windows.
GPS and/or barometer data is not stored with sonde data file.	Make sure Store barometer and Store Lat and Long are active in 650 Logging setup menu.
Site Designations in the Site List are “grayed-out” and not available for appending files with additional data. A “Parameter Mismatch” screen is displayed.	There is a parameter mismatch between the current 650 setup and that initially used. Use 650 File view and the Parameter Mismatch screen to determine the sonde parameter, barometer, and GPS format of file already present in memory and readjust the setup to match that initially used.
GPS data is not shown in Status Bar.	Make sure that (a) the cables are attached properly; (b) that the GPS unit is configured for NMEA 0183 format; (c) that the GPS unit is “locked in” and that the GPS unit display is showing proper readings.
The 650 display flashes and the instrument speaker makes a continuous clicking sound.	The battery voltage is low. Change to new C cells or recharge the 6117 battery pack.
The sonde/650 resets when optical wipers are activated in the sonde.	The battery voltage is low. Change to new C cells or recharge the 6117 battery pack.

If these guidelines and tips fail to correct your problem or if any other symptoms occur, contact YSI Customer Service for Advice. See Section 8 of the 6-series manual for contact information.

3.12 FERRITE BEAD INSTALLATION

WARNING: If you are using your 650 in a European Community (CE) country or in Australia or New Zealand, you must attach a ferrite bead to the 655174 PC Interface Cable and the 6116 Charger Adapter Cable in order to comply with the Residential, Commercial and Light Industrial Class B Limits for radio-frequency emissions specified in EN55011 (CISPR11) for Industrial, Scientific and Medical laboratory equipment. These ferrite assemblies are supplied as part of cable kits.

To install the beads, follow these steps:

- Make a small loop (approximately 5 cm in diameter) in the cable near the 650 MS-8 connector.
- Lay the open ferrite bead assembly under the loop with the cable cross-over position within the cylinder of the ferrite bead. See the drawing below for assistance.

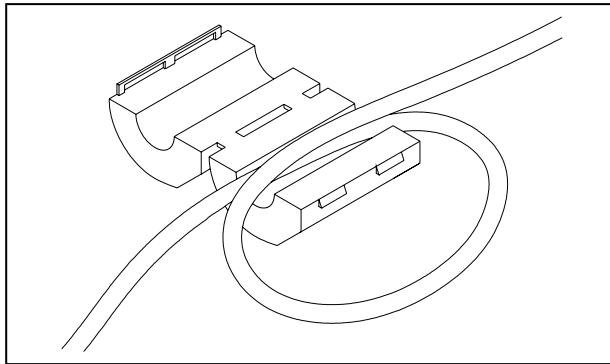

- Snap the two pieces of the bead together making certain that the tabs lock securely.

When the installation is complete, the 655174 and 6116 cables should resemble the following schematic drawings.

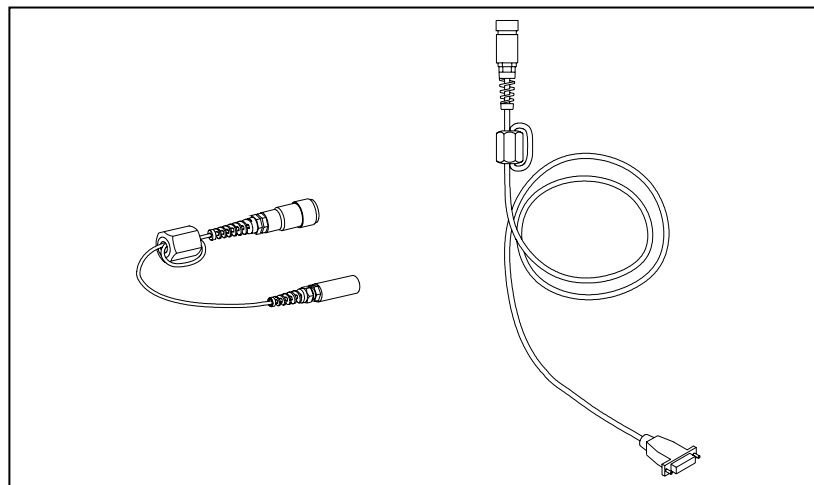

3.13 650 SAFETY CONSIDERATIONS

IMPORTANT SAFETY INSTRUCTIONS!

SAVE THESE INSTRUCTIONS!

 In essence, the most important safety rule for use of the 650 is to utilize the instrument **ONLY** for purposes documented in this manual. This is particularly true of the 6117 rechargeable battery pack that contains nickel metal hydride (NiMH) batteries. The 650 user should be certain to read all of the safety precautions outlined below before using the instrument.

6113 Rechargeable Battery Pack Safety Information

Restrictions on Usage

1. Never dispose of the battery pack in a fire.
2. Do not attempt to disassemble the 6117 battery pack.
3. Do not tamper with any of the electronic components or the batteries within the battery pack. Tampering with either the electronic circuitry or the batteries will result in the voiding of the warranty and the compromising of the system performance, but, more importantly, can cause safety hazards which result from overcharging such as overheating, venting of gas, and loss of corrosive electrolyte.
4. Do not charge the battery pack outside the 0-40 C temperature range.
5. Do not use or store the battery at high temperature, such as in strong direct sunlight, in cars during hot weather, or directly in front of heaters.
6. Do not expose the battery pack to water or allow the terminals to become damp.
7. Avoid striking or dropping the battery pack. If the pack appears to have sustained damage from these actions or malfunctions after an impact or drop, the user should not attempt to repair the unit. Instead, contact YSI Customer Service.
8. If the battery pack is removed from the 650, do not store it in pockets or packaging where metallic objects such as keys can short between the positive and negative terminals.

Precautions for Users with Small Children

Keep the battery pack out of reach of babies and small children.

⚠ Danger Notifications – Misuse creates a STRONG possibility of death or serious injury.

FAILURE TO CAREFULLY OBSERVE THE FOLLOWING PROCEDURES AND PRECAUTIONS CAN RESULT IN LEAKAGE OF BATTERY FLUID, HEAT GENERATION, BURSTING, AND SERIOUS PERSONAL INJURY.

1. Never dispose of the battery pack in a fire or heat it.
2. Never allow the positive and negative terminals of the battery pack to become shorted or connected with electrically conductive materials. When the battery pack has been removed from the 650, store it in a heavy plastic bag to prevent accidental shorting of the terminals.
3. Never disassemble the battery pack and do not tamper with any of the electronic components or the batteries within the battery pack. The battery pack is equipped with a variety of safety features. Accidental deactivation of any of these safety features can cause a serious hazard to the user.
4. The NiMH batteries in the battery pack contain a strong alkaline solution (electrolyte). The alkaline solution is extremely corrosive and will cause damage to skin or other tissues. If any fluid from the battery pack comes in contact with a user's eyes, immediately flush with clean water and consult a physician immediately. The alkaline solution can damage eyes and lead to permanent loss of eyesight.

⚠ Warning Notifications – Misuse creates a possibility of death or serious injury

1. Do not allow the battery pack to contact freshwater, seawater, or other oxidizing reagents that might cause rust and result in heat generation. If a battery becomes rusted, the gas release vent may no longer operate and this failure can result in bursting.
2. If electrolyte from the battery pack contacts the skin or clothing, thoroughly wash the area immediately with clean water. The battery fluid can irritate the skin.

⚠ Caution Notifications – Misuse creates a possibility of mild or serious injury or damage to the equipment.

1. Do not strike or drop the battery pack. If any impact damage to the battery pack is suspected, contact YSI Customer Service.
2. Store the battery pack out of reach of babies and small children.
3. Store the battery pack between the temperatures of -20 and 30 C.
4. Before using the battery pack, be sure to read the operation manual and all precautions carefully. Then store this information carefully to use as a reference when the need arises.

616 Cigarette Lighter Charger Safety Information

1. This section contains important safety and operating instructions for the 650 cigarette lighter battery charger (YSI Model 616; RadioShack Number 270-1533E). **BE SURE TO SAVE THESE INSTRUCTIONS.**
2. Before using the 616 cigarette lighter charger, read all instructions and cautionary markings on battery charger, battery pack, and Model 650.
3. Charge the 6117 battery pack with the 616 cigarette lighter charger **ONLY** when the 6117 is installed in the YSI 650.
4. Do not expose charger to rain, moisture, or snow.
5. Use of an attachment not recommended or sold by the battery charger manufacturer may result in a risk of fire, electric shock, or injury to persons.
6. To reduce risk of damage to cigarette lighter and cord, pull by cigarette lighter rather than cord when disconnecting charger.
7. Make sure that the cord is located so that it will not be stepped on, tripped over, or otherwise subjected to damage or stress.
8. Do not operate charger with damaged cord or cigarette lighter connector – replace it immediately.
9. Do not operate charger if it has received a sharp blow, been dropped, or otherwise damaged in any way; contact YSI Customer Service.
10. Do not disassemble charger other than to change the fuse as instructed. Replace the part or send it to YSI Product Service if repair is required. Incorrect reassembly may result in a risk of electric shock or fire.
11. To reduce risk of electric shock, unplug charger before attempting any maintenance or cleaning. Turning off controls will not reduce this risk.

650 Water Leakage Safety Information

The 650 has been tested and shown to comply with IP67 criterion, i.e. submersion in 1 meter of water for 30 minutes with no leakage into either the battery compartment or the main case. However, if the instrument is submersed for periods of time in excess of 30 minutes, leakage may occur with subsequent damage to the batteries, the rechargeable battery pack circuitry, and/or the electronics in the main case.

If leakage into the battery compartment is observed when using alkaline C cells, remove batteries, dispose of batteries properly, and dry the battery compartment completely, ideally using compressed air. If corrosion is present on the battery terminals, contact YSI Customer Service for instructions.

If leakage into the battery compartment is observed when using the 6117 rechargeable battery pack, remove the battery assembly and set aside to dry. Return the battery pack to YSI Product Service for

evaluation of possible damage. Finally dry the battery compartment completely, ideally using compressed air. If corrosion is present on the battery terminals, contact YSI Customer Service for instructions.

 **CAUTION:** If water has contacted the rechargeable battery pack, do not attempt to reuse it until it has been evaluated by YSI Product Service. Failure to follow this precaution can result in serious injury to the user.

If it is suspected that leakage into the main cavity of the case has occurred, remove the batteries immediately and return the instrument to YSI Product Service for damage assessment.

CAUTION: Under no circumstances should the user attempt to open the main case.

3.14 650 MDS SPECIFICATIONS

Resistance to Water Leakage: IP 67 for both the standard alkaline battery configuration and for the rechargeable battery pack option.

Operating Temperature Range for Visible Display: -10 to 60 Degrees Celsius

Storage Temperature Range: -20 to 70 Degrees Celsius

Dimensions: 9.13 inches long by 4.75 inches wide by 2.25 inches deep

Weight with 4 Alkaline C cells and no attached sonde or cable: Approximately 2.1 lbs. (960 g).

Display: ¼ VGA; LCD with 320 by 240 pixels with backlight

Connector: MS-8; Meets IP 67 specification

Standard Battery Configuration:

4 Alkaline C Cells with detached battery cover

Optional Battery Configuration:

Nickel Metal Hydride Battery Pack with attached battery cover and 110 volt charger

Battery Life:

Approximate battery life for typical sampling applications with 4 alkaline C cells – 3 hours of “on” time per day for 0.5 month (10 working days) with the meter powering a 6600 sonde with all probes active.

Approximate battery life for typical sampling applications with rechargeable battery pack – 3 hours of “on” time per day for 0.2 months (4 working days) with the meter powering a 6600 sonde with all probes active. Battery capacity restored completely with a 6-hour charge and charged to approximately 85 % with a 2-hour charge.

Barometer:

Range: 500 to 800 mm Hg

Resolution: 0.1 mm Hg

Accuracy: +/- 3 mm Hg within +/- 15 C of the calibration temperature

Communication Protocol:

RS-232 to all sondes and for data transfer to PC and for software updates

GPS via Y-cable – NMEA 0183

Standard Backlight Feature: 4 LEDs illuminating LCD

Keyboard: 20 keys including Meter On/Off, Backlight On/Off, Enter, Escape, 10 Number/Letter Entry Keys, 2 Vertical arrow keys, 2 Horizontal arrow keys, 1 minus/hyphen entry key, 1 decimal point/period

SECTION 4 ECOWATCH FOR WINDOWS

4.1 INTRODUCTION

EcoWatch for Windows is intended to be the PC software interface to YSI's 6-Series environmental monitoring systems equipment. From EcoWatch you can program field equipment, upload data collected on the equipment, and format the data in easy to understand graphs and tables.

4.1.2 GLOSSARY

These are a few of the more commonly used terms used in EcoWatch.

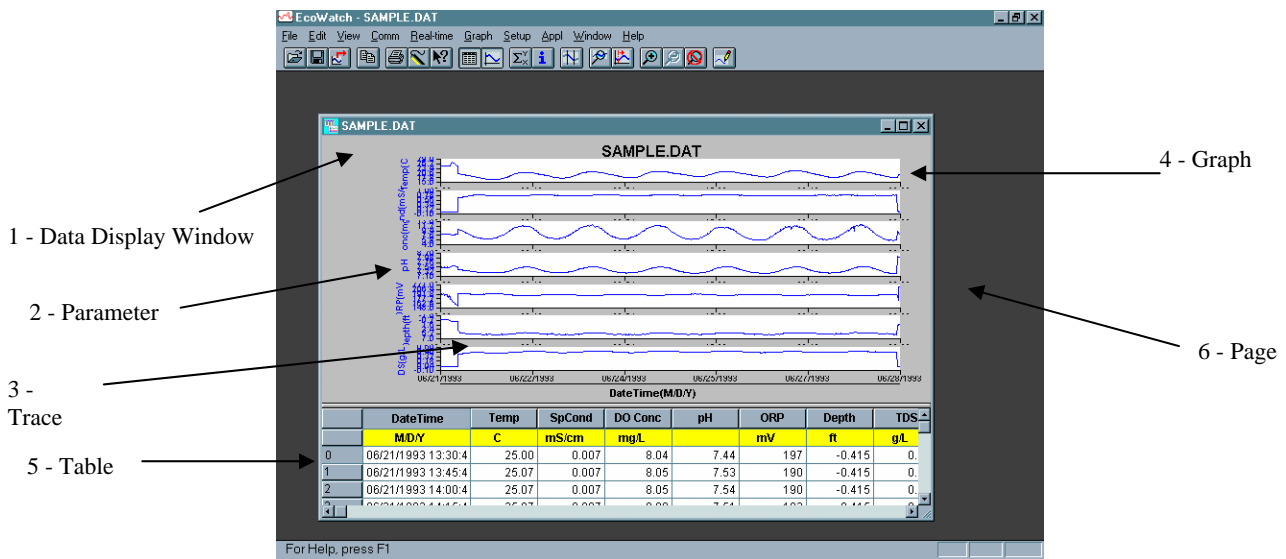

Term	Definition
1 - Data display window	The window that appears when you open a .DAT file.
2 - Parameter	A measurement such as temperature, dissolved oxygen, pH, etc. On a graph, the data of a parameter is displayed as a trace.
3 - Trace	The plot of the data of any one parameter. There may be one or two traces per graph.
4 - Graph	There may be one or more graphs depending upon how many parameters are selected. Each graph may have one or two traces. Data can be displayed either in graphs or in a table, or both.
5 - Table	Numbers arranged in rows and columns. Data can be displayed either in graphs or in a table, or both.

6 - Page

The Data Display Window can be divided into two pages, a graph page and a table page. A page becomes active when you click on it.

7 - Terminal window

This is the window that is open to display the sonde's internal menu. Allows the user to interact with the sonde or display/logger. The terminal window is a communication interface with another piece of equipment, whereas the Data Display Window is direct interaction with the EcoWatch software.



8 - Dialog box

A dialog box opens to display choices. Such as File Open.

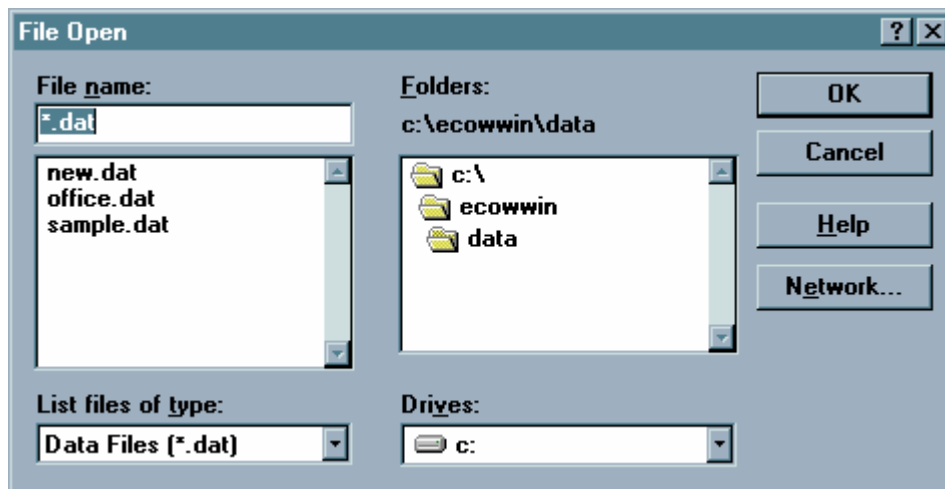

9 – PC6000 data file

A data file that is in a format compatible with EcoWatch for Windows or PC6000 software.

9 – Study

A single data file in PC6000 format.

4.1.3 TUTORIAL



This brief EcoWatch tutorial is to be used with the sample data file that is provided with EcoWatch.

EcoWatch starts without an open data file (or .DAT file). When a data file is not open, a shortened menu bar is visible and many of the tools in the toolbar appear dimmed. Opening a data file will better demonstrate the capabilities of EcoWatch software.

To open the sample data file:

1. Click the **File** menu  button in the toolbar.
2. Select the **SAMPLE.DAT** file.
3. Click **OK** to open the file.

Note that the data in this file appears as a graph of temperature, specific conductance, dissolved oxygen, pH, ORP, and depth, all versus time. The graphs are scaled automatically so that all data fits comfortably on the computer screen.

The **Table**  and **Graph**  buttons on the toolbar are on/off switches that are used to display or hide the graph and table pages respectively. When displaying a graph and a table at the same time, you can control the relative size of the two pages by placing the cursor over the small bar that separates them and then dragging it to the desired location.

From the **Setup** menu, click **Graph**. Click **2 Traces per Graph** and notice that the parameters are now graphed in pairs. Click **1 Trace per Graph** to return the display to the original setting. Move the cursor to any position in the graph, then click and hold the right mouse button. Note that the exact measurements for this point in time are displayed to the left of the graph. While holding down the right mouse button, move to another area on the graph. Notice how the measurements change as you move. When you release the mouse button, the display returns to normal.

To view statistical information for the study, click the **Statistics**  button on the toolbar. On the statistics window, click on any min or max value to display the time when it occurred. Double-click in the upper left of the Statistics window to return to the normal display.

End the tutorial by saving the Data Display in the format shown. To do this:

1. From the **File** menu, click **Save Data Display**.
2. Type Default for the file name when prompted for the Data Display Name.
3. Click **Save**.

The parameters, colors, format, and x-axis time interval associated with the current display are now saved and can be accessed any time in the future. Nine different data displays may be saved for any data file. You can easily switch between various displays of the data.

This demonstration shows only a small part of the capability of EcoWatch. You may wish to also review the procedures involved in the **Section 4.1.5, Typical Application**.

4.1.4 USING THE TOOLBAR

The EcoWatch toolbar includes buttons for some of the most common commands in EcoWatch, such as **File Open**. To display or hide the toolbar, open the **View** menu and click on the **Toolbar** command. A check mark appears next to the menu item when the toolbar is displayed. The toolbar is displayed across the top of the application window, below the menu bar.



Click To:



Open an existing data file (.DAT). EcoWatch displays the **Open** dialog box, in which you can locate and open the desired file.



Save the working Data Display of the active data file. EcoWatch displays the **Save Data Display** dialog box in which you can overwrite existing Data Display or save to a new one.



Export data as a graph in Window Meta File (.WMF) format or as data in Comma Delimited (.CDF) format.



Copy the whole graph page or data from the selection on the table to the clipboard.



Print the active graph page or table page depending on which one is currently active.



Open a new terminal window to communicate with the sonde.



Access context sensitive help (Shift+F1).



Toggle table window during file processing.



Toggle graph window during file processing.



Display study statistics.



Display study info.



Limit the data to be processed in a study.



Enlarge a selective portion of graph.



Center the graph under the cursor.



Enlarge graph or table 20%.



Reduce graph or table 20%.



Return graph or table to its normal state (unzoom)



Redraw the graph.

4.1.5 TYPICAL APPLICATION

Suppose you want to measure Dissolved Oxygen, pH, Temperature, and Turbidity in a nearby stream and decide to start with a 30-day deployment using the YSI 6920 sonde. The task can be organized into several steps:

1. Calibrate and setup the sonde.

First connect your sonde to one of the serial communications ports on your PC. In the **Comm** menu, click **Sonde** and you will get a terminal window where you can calibrate the sonde and set it up for logging. You are now communicating directly with the sonde software. See **Section 2.6, Calibration** for more detailed instructions on calibration of sensors. See **Section 2.5, Sonde Software Setup** for sonde setup.

2. Deploy the Sonde

For more details, see **Section 2, Sondes** and **Section 3, Displays/Loggers**.

3. Retrieve the Sonde and Upload the Data

After retrieving the sonde, connect it to your PC and upload the data. As with calibration and setup, you can use the Sonde  button in EcoWatch to communicate with the sonde. Using the sonde menu, upload the data to EcoWatch. The data will now be in a .DAT file on your PC.

4. Graph the Data and Adjust the Graphs to Your Liking

Open the newly uploaded .DAT file. In this example, the file is called JONES2.DAT. Upon opening the file it looks like the graphic at the end of this tutorial. You can then use the commands in the **Graph** menu to **Zoom** to the portion of the graph that you are most interested in. You can use the **Setup** menu to add a title or change colors, scale the graphs or select the parameters to be shown.

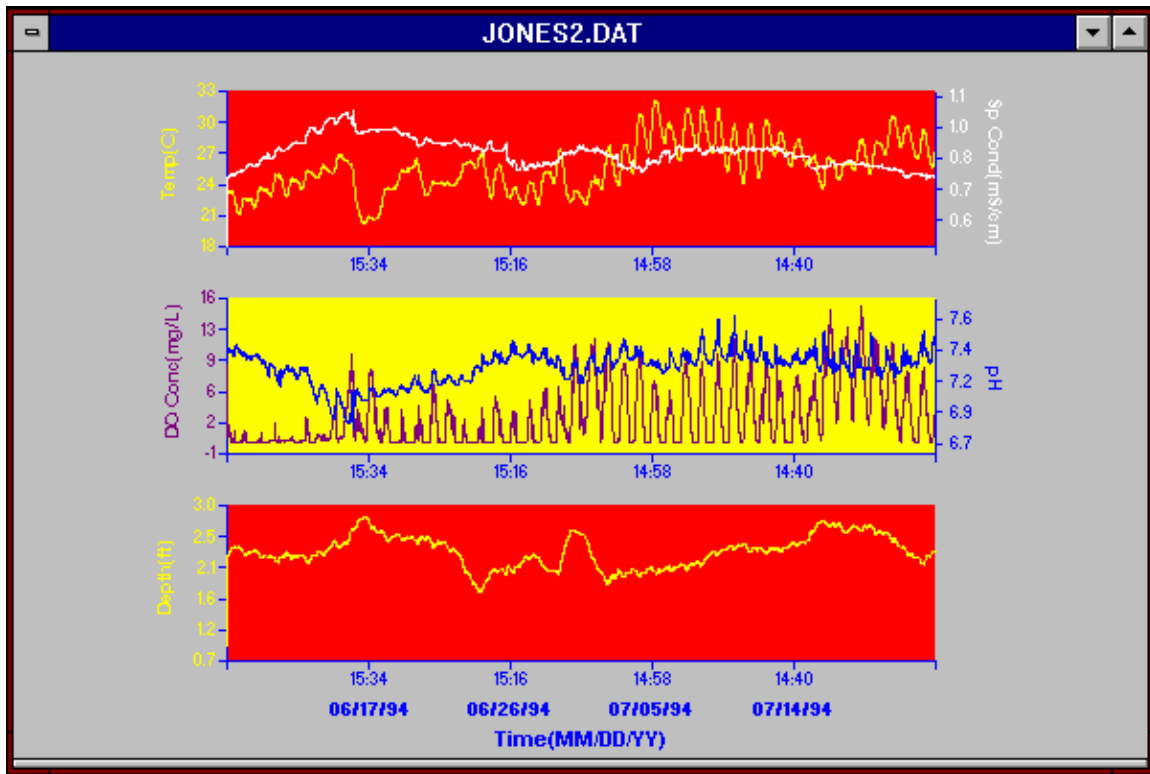

5. Print Your Graph

To print the graph, open the **File** menu, choose **Print Setup** or **Print** to choose exactly how the print should look.

4.2 DATA ACQUISITION AND ANALYSIS

4.2.1 CONNECT A YSI SONDE OR A 650 DISPLAY/LOGGER

EcoWatch may be used with various sondes or display/loggers. To utilize the configuration that will work best for your application, make sure that you have all of the components that are necessary.

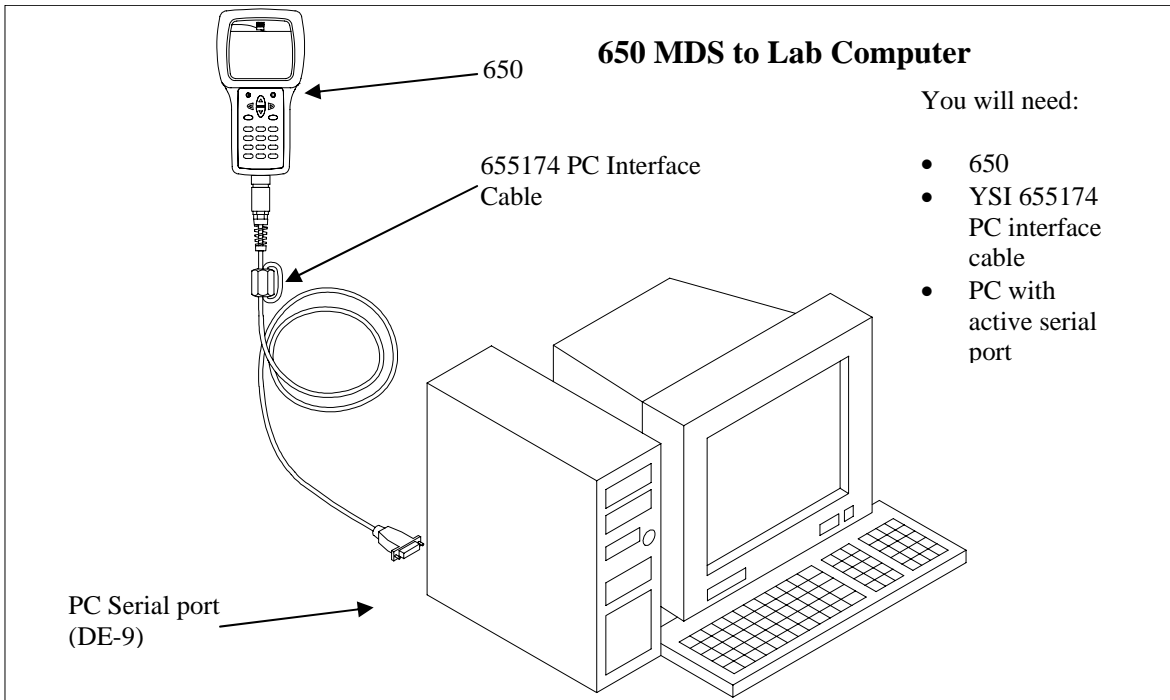
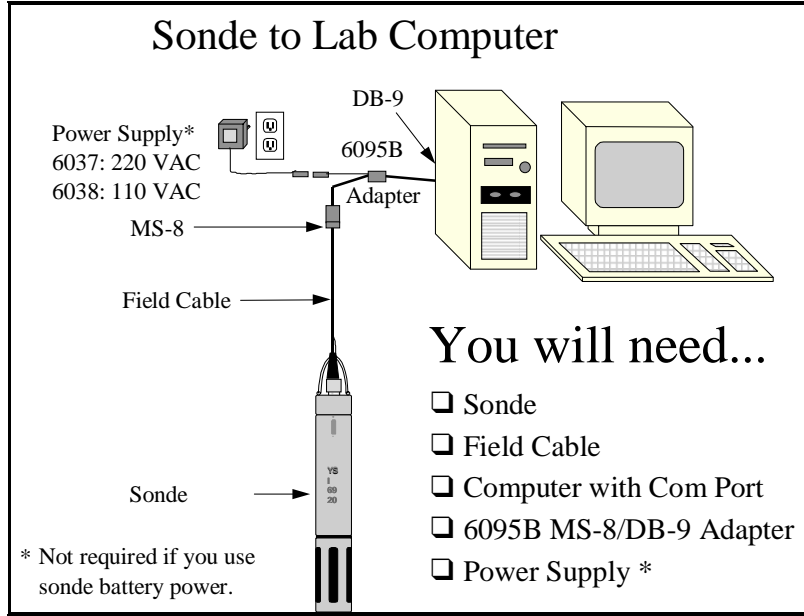

A sonde or 650 display/logger must be connected to one of the serial communication ports on the back of your PC. These ports are usually referred to as COM1, COM2, etc. Most computers have at least two COM ports but they are often not labeled. To identify a COM port, look for unused 9 or 25 pin, D-shaped connectors with pin contacts.

Some sondes have integral cables and others require a separate cable sold especially for use with the sonde. Depending on the exact connector on your PC, you may also need a 9 to 25 pin adapter.

There is an PC interface cable for the 650 display/loggers that has a 9 pin D-shaped connector. This connector must be attached to your computer.

Once physically connected, you are ready to communicate using EcoWatch. Use the **Sonde** command in the **Comm** menu or the sonde button on the toolbar. This will give you a terminal window. From this window you interact with the sonde software using its menu system, or upload a file from a 650 display/logger. See **Section 2, Sondes** for details on how to use the sonde software.

4.2.2 UPLOAD A FILE FROM A SONDE

Data that is processed in EcoWatch typically originates in a sonde with batteries and is uploaded to a PC. To upload data from a YSI sonde, connect the sonde to your PC and open the EcoWatch software. Use the Sonde button on the toolbar to communicate with the sonde software.

Using the sonde software, go to the **Main menu** by typing “**menu**” on the blank terminal screen. Then choose **3-File Menu**. You will most likely be uploading the most recently recorded data. If so, simply press **3-Quick Upload**. Otherwise, press **2** to choose a file to upload. The sonde will ask you to choose a format for the file. Be sure to choose **PC6000 format**. After it is uploaded, the data will be in a **.DAT** file on your PC. You can then use EcoWatch to view, manipulate and print the data file.

4.2.3 UPLOAD A FILE FROM A 650 DM DISPLAY/LOGGER

To transfer data files resident in the 650 memory (either logged directly or uploaded from sonde memory) to a PC that is running YSI EcoWatch for Windows software, you must first connect the 650 to a serial port of your computer via the 655174 PC Interface cable as shown in the diagram above.

After the connection is made, run EcoWatch for Windows, click on the sonde icon in the upper toolbar, and set the Comm port number to match your interface. After this setup procedure, the following screen will be present on your PC monitor:

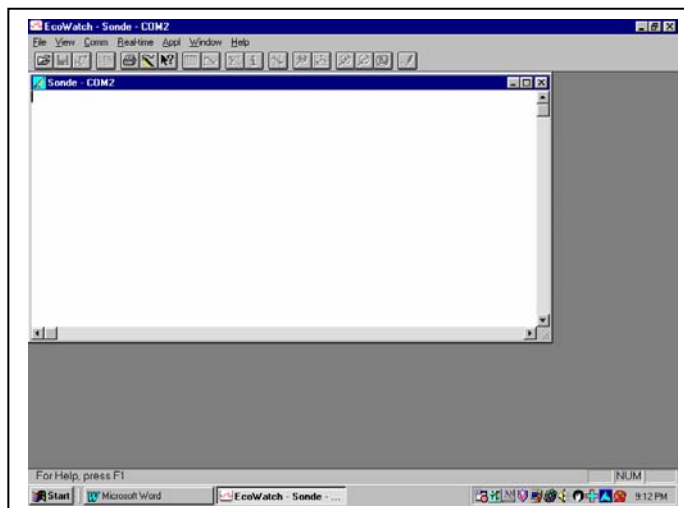

To transfer data from the 650 to your PC, highlight the **Upload to PC** selection in the 650 File menu and press **Enter** to view a list of the files. Highlight the file that you wish to transfer and press **Enter**. The 650 and PC displays will show the progress of the file transfer until completion.

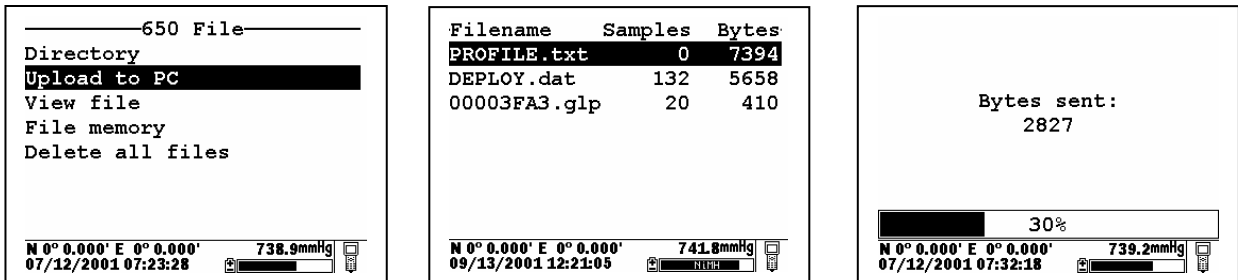

Note that there are three file types (with different extensions) in the above directory: (1) Files with .dat extensions which are data files logged to either sonde memory of 650 memory and which are in YSI PC6000 format; (2) Files with a .txt extension which are data files logged to sonde memory and then transferred to 650 memory in either ASCII or CDF format; and (3) Files with a .glp extension which are calibration records of either the sonde sensors or the 650 barometer. For files with a .dat or .txt extension, transfer to a PC using the **Upload to PC** command will proceed automatically and retain the file type that is present in 650 memory. For files with a .glp extension, an additional screen will appear on activating the transfer that gives a choice of binary, CDF, or ASCII for moving the file to the computer. You currently **MUST** use either the CDF or ASCII format for transfer so that the .glp file can be viewed in NotePad or other word processing program. The binary transfer option is for future YSI upgrades.

After transfer the file will be located in the C:\ECOWWIN\DATA subdirectory of your PC hard drive.

4.2.4 USING THE GRAPH

Once uploaded, data can be easily displayed in EcoWatch. Open a .DAT file. The six buttons on right side of the toolbar help you get a closer view of that portion of the graph you desire.

Zoom Window 



Use this to select a certain portion of the graph to be displayed. Click the button and then click and drag on the graph to select the portion you want to view. The pointer will change to a magnifying glass. The button will stay active until you click on it again.

Center Scroll 

Use this to scroll through the study. Click the button and the pointer will change to a bullseye. Click anywhere on the graph and that spot will move to the center.

Limit Data Set 

Use this button to reduce the data being processed and speed up operations. Click the button and move the pointer to the graph. A vertical arrow will appear with an N on the left and an Y on the right. Bracket the desired portion of the graph by moving the cursor to the left limit, clicking, moving to the right limit and clicking again. To limit the data in a table, move the pointer to the far left of the table into the row numbers area and highlight from the desired cutoff point to the beginning or end of the data set, whichever is desired. Then select the **Limit Data Set** option from the **Graph** menu or use the toolbar shortcut. To remove the limits, from the **Graph** menu choose **Cancel Limits**. You may also remove the limits using this button by clicking first on the right and then the left.

- Unzoom**  Use this button to view the study from the beginning limit to the end limit. This command can be used on both graphs and data tables.
- Zoom In**  Click this button to magnify by 20%. This command can be used on both graphs and data tables.
- Zoom Out**  Click this button to reduce magnification by 20%. This command can be used on both graphs and data tables.

4.2.5 GRAPH DATA IN REAL TIME

Choosing the **New** command from the **Real-time** menu will bring up a window with graphs that plot data from the sonde as the measurements are being taken. If you do not have a default COM port set in the **Communications Settings** dialog, then you will be asked which COM port to use for the real-time measurements. If you do have a default port selected, then the program will use that port automatically.

The number of parameters displayed during real-time is set by the sonde. If four parameters are set in the Report setup in the sonde, then those same parameters will be displayed in real-time. If you want to change the parameters displayed, then you must close the real-time window, open a sonde terminal window, change the number of parameters in the sonde software menu, and then return to real-time measurements.

The **Settings** command in the **Real-time** menu takes you to a dialog where you can set the x-axis time and the sample interval.

4.3 ECOWATCH MENU

4.3.1 FILE

The **File** menu offers the following list of commands. Some commands are available only when a file is open.

OPEN

Use this to open sonde data file (.DAT).

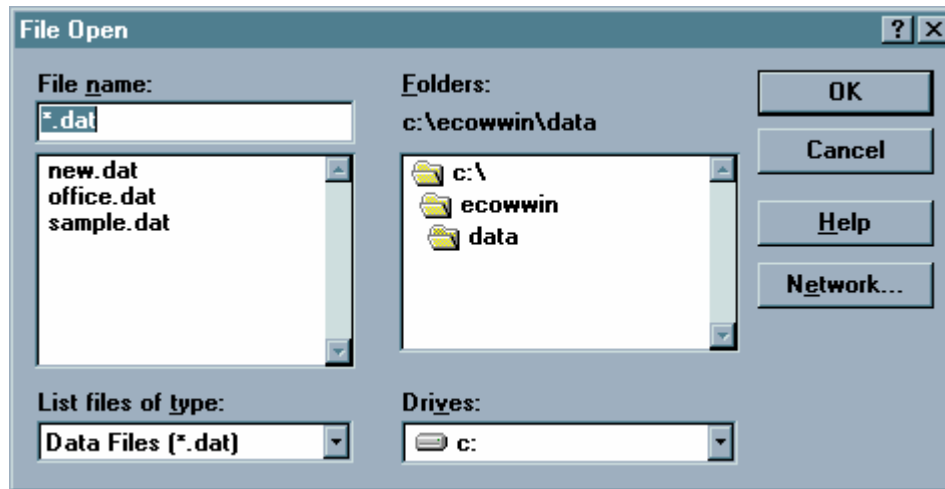

File Name Type or select the filename you want to open. This box lists files with the extensions you select in the **List Files of Type** box.

List of Files of Type Select the type of file that you want to open.

*.dat	Sonde binary data file
*.txt, *.prn	ASCII text file
*.cdf, .csv, .sdf	Comma delimited file
*.rt	Real-time file
*.cr1	CR10 file

Drives Select the drive where the PC6000 data file resides.

Directories Select the directory where the PC6000 data file resides.

Network... Choose this button to connect to a network location, assigning it a new drive letter. This button is hidden if your computer is not connected to a network. The screen above has the network button hidden.

CLOSE

Use this command to close all windows containing the active document. EcoWatch automatically saves any changes before the file is closed.

You can also close a document by using the **Close** icon on the document's window, as shown below:



IMPORT

With this command, you can import common ASCII files into EcoWatch. The file will be converted into PC6000 format and again with a .DAT extension.

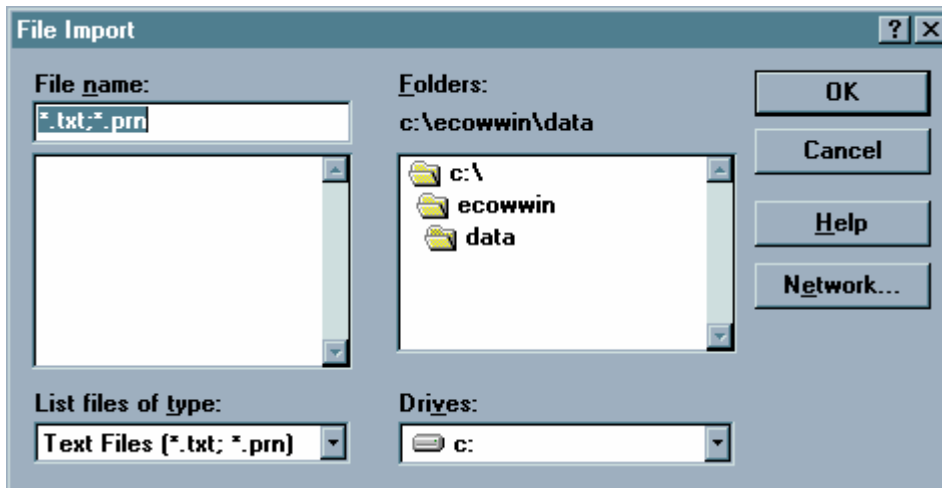

MERGE

This function takes two existing data files and merges them into one new file. Both files must be in PC6000 format (.DAT), have the same number of parameters, and the same parameter types (the parameter setup must be identical). Data record time-stamps in the destination data file will be stored in ascending order.

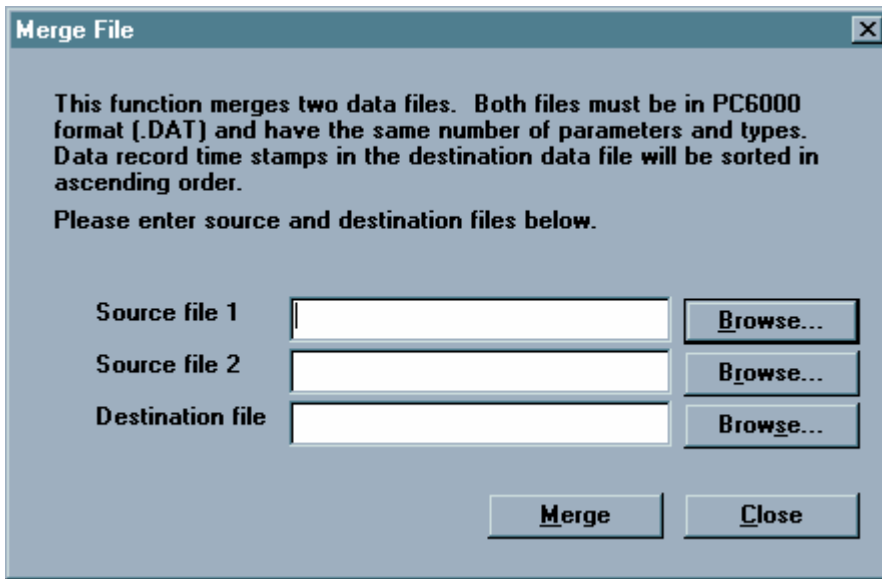

COPY TO CLIPBOARD

If a graph or table is active, then choosing this command will send its contents to the Windows clipboard so that it can be pasted into other programs. This is a normal method of transfer data between different Windows programs.

Shortcuts

Toolbar: 

Keys: CTRL+C

SAVE DATA DISPLAY

When opening a data file, you will probably want to look at the data in graph form. You may also want to rearrange the default graph by selecting or reordering parameters, zooming in to a portion of the graph, or even changing colors or changing fonts. You may sometimes choose to look at the data or a portion of it in table form. All of this work is done in the Data Display window.

This command allows you to save the settings and content of the Data Display window so that you can load it at another time and have it look exactly the same as when you saved it. This saved display is associated with the data file. Up to 9 data displays can be saved per data file. When you save a display you will be asked to give it a name in the following dialog box.

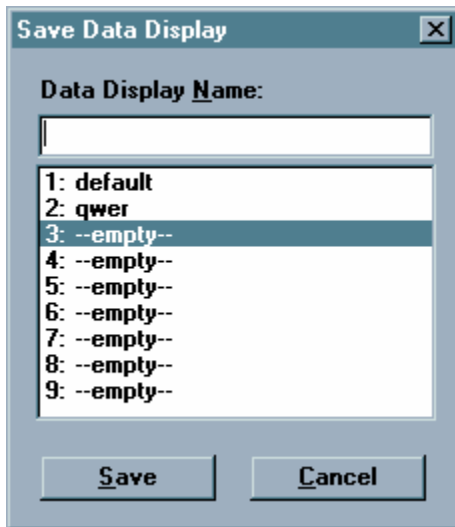

There must be an open data file for this command to be available. See also **Load Data Display**.

Shortcuts

Keys: CTRL+S

LOAD DATA DISPLAY

This command is only available when a data file is open. If you have previously used the **Save Data Display** command for the open data file, then you can load the saved display and have it look exactly the same as when you saved it. Saved displays are associated with the data file. You can have as many as nine saved displays for each data file. When loading a display you will be asked to choose from among the names of saved displays.

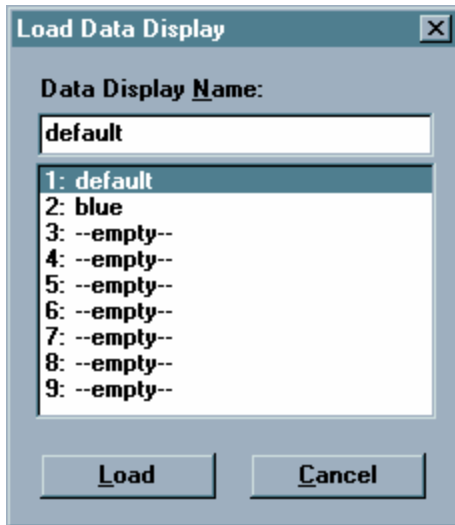

EXPORT

Use this command to send the current data to a file. Typically, some other program will read the file. You will see the following dialog box.

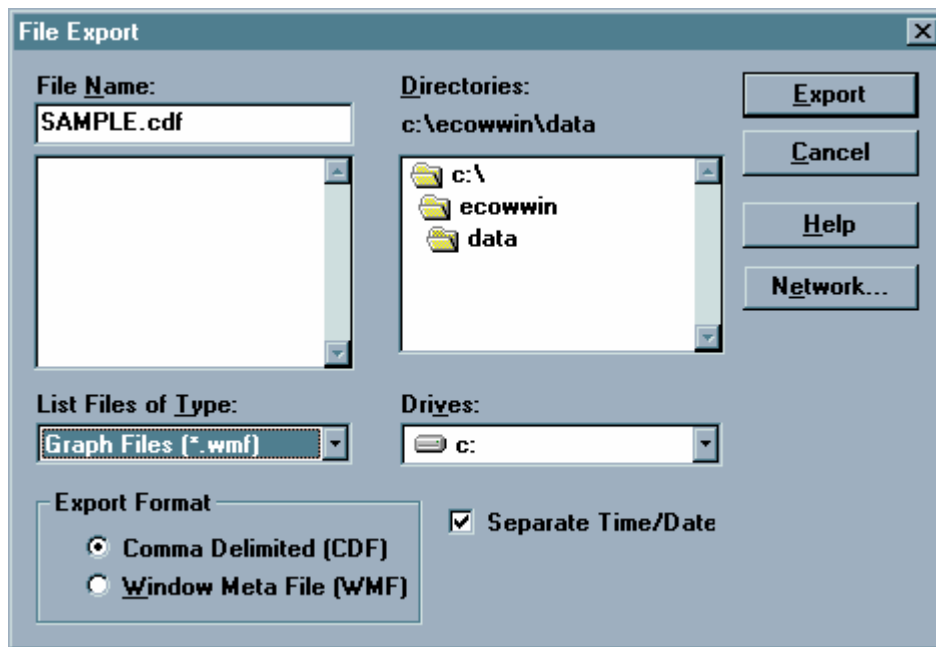

You may export the file in either of two forms: a WMF file, or a .CDF file.

WMF stands for Windows MetaFile and is a format that describes any image in a way that is independent of the program that generated the image. For example, you can generate a graph in EcoWatch, export it as a .WMF file and then import it into another Windows program.

CDF stands for Comma Delimited, sometimes referred to as a Comma and Quote Delimited File. This format is commonly used by spreadsheet and database programs. In this type of file, commas separate

individual data entries, quotation marks surround any text and no formatting or marking is performed on numbers. EcoWatch can also open files in CDF formats.

When the exported file is to be imported into a spreadsheet, it is sometimes convenient to reduce the number of data. Averaging them can easily do this. See **Change Parameter Attributes** for more information.

Shortcuts

Toolbar: 

REPORT

Use this command to send data or statistics to an ASCII text file. The information is easy to read in this format. When choosing this command the following dialog box will appear.

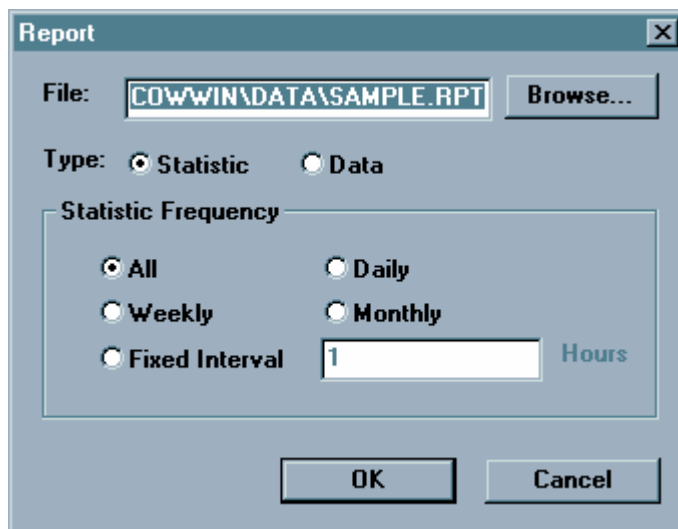

- You must enter a filename (under **File**; use the **Browse** button if needed). If you want to simply have a report **Type** listing the data, then click **Data**. If you want **Statistics** (minimum, maximum, average, and standard deviation), then the statistics frequency button applies.
- If you want to have **Daily** statistics, keep in mind that every day actually starts at midnight. It would be likely then that the first and last days would have very different statistics because they would only be partial days. **Daily**, **Weekly** and **Monthly** statistics behave similarly.
- When you click **OK**, EcoWatch will send the report to the specified file and open **Windows Notepad** where you can view and/or print the report. Note: Notepad can only open report files that are 64K or less in size. You can use the Windows Wordpad to open reports that are larger than 64K. Unless you change it, the report file will have the same location as your data file (.DAT) and has the same name with a .RPT file extension.

PRINT

Use this command to print a document. If a graph is selected, this command presents a **Print Option** dialog box with the options below. When a table is selected, a standard print window is

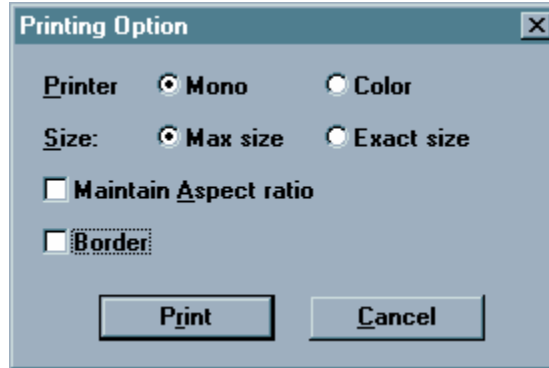

presented.

Shortcut

Toolbar: 
 Keys: CTRL + P

Printer

If you have a color printer, you can choose to print in **Color**. Otherwise you should choose **Mono** (black and white).

Size

If you choose **Max** size, then the program will size the graph so that it fits on one page. If you choose **Exact** size, then program will print the graph as close as possible to the size that is displayed.

Maintain Aspect Ratio

If you choose to maintain the aspect ratio, then the program will size the graph until either the height or the width is maximized and then leave the graph in the same height width ratio that is displayed.

Border

You can also choose whether or not to print a border.

PRINT PREVIEW

This command allows the user to preview how the document will appear when it is printed. This command only works for data that is displayed in a table format, not when the data is in graph format.

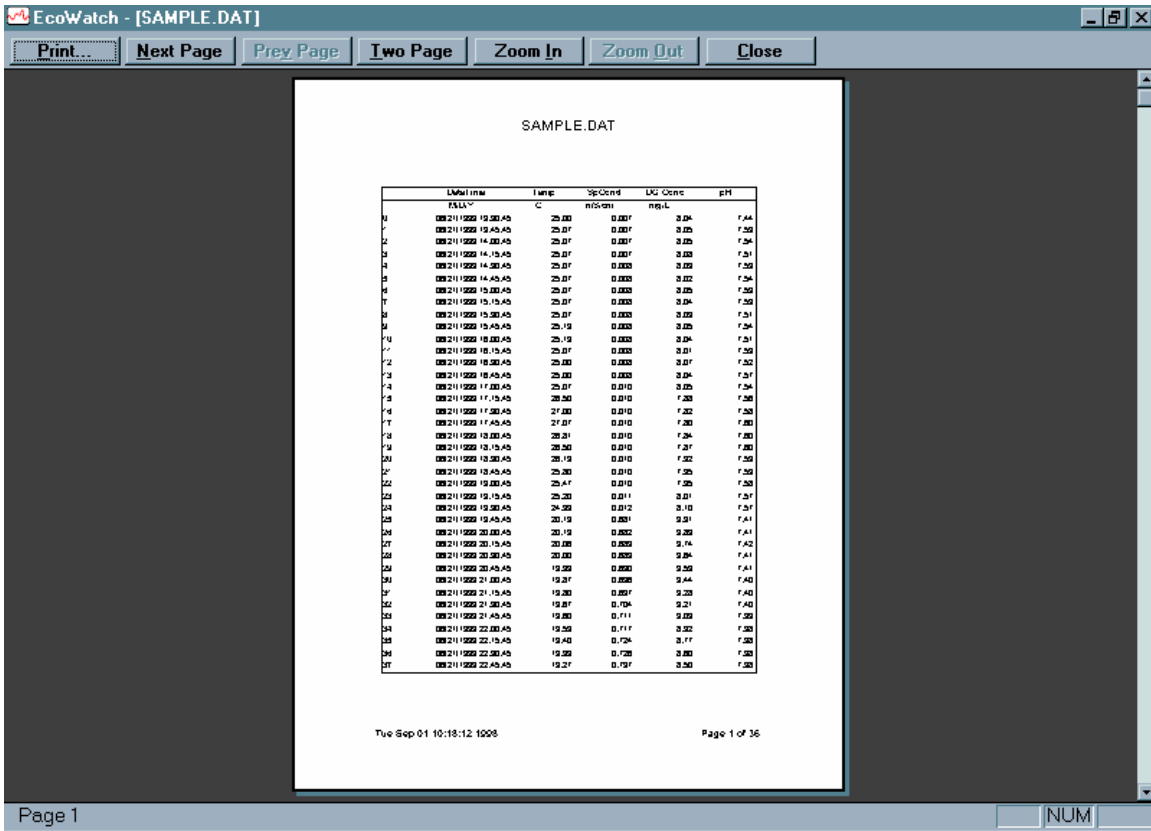

PRINT SETUP

Use this command to select a printer and a printer connection. This command presents the **Print Setup** dialog box. The following options allow you to select the destination printer and its connection.

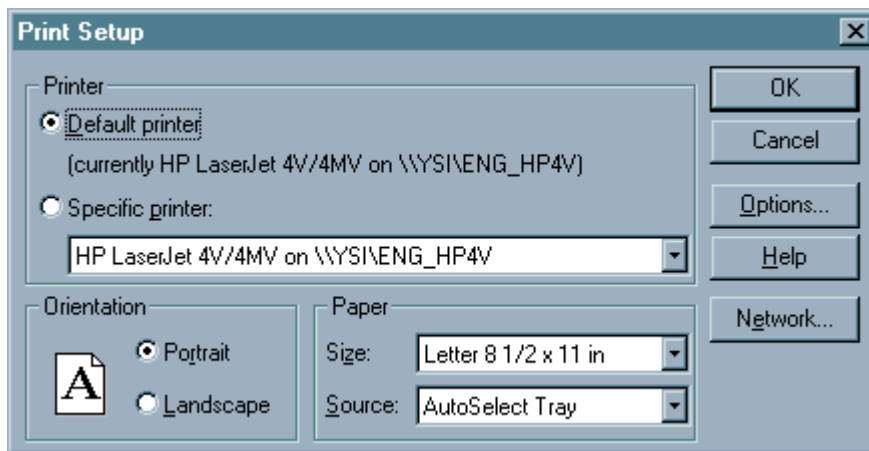

Printer

Select the printer you want to use. Choose the **Default Printer**; or choose the **Specific Printer** option and select one of the current installed printers shown in

the box. You install printers and configure ports using the Windows Control Panel.

- Orientation** Choose **Portrait** or **Landscape**.
- Paper Size** Select the size of paper that the document is to be printed on.
- Paper Source** Some printers offer multiple trays for different paper sources. Specify the tray here.
- Options** Displays a dialog box where you can make additional choices about printing, specific to the type of printer you have selected.
- Network** Displays a dialog box that allows you to choose a printer if you are on a network.

PAGE SETUP

Layout options for printable data tables may be specified. Page margins, table setup, page orientation, and page order are adjustable.

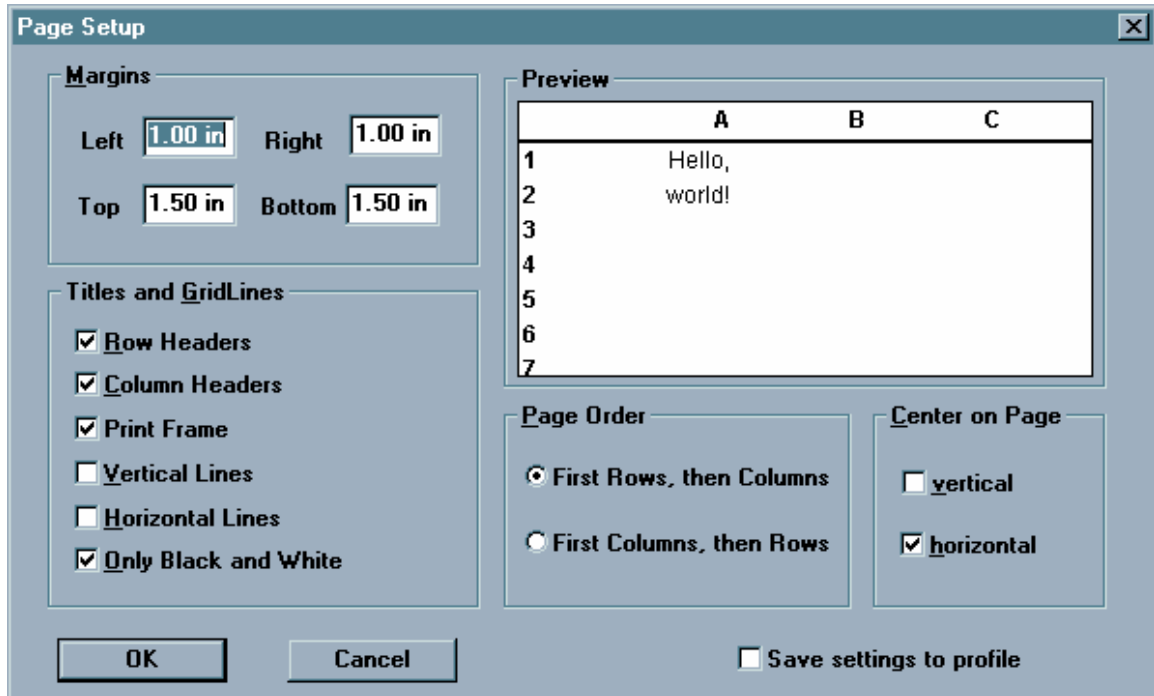

HEADER/FOOTER

Page headers and footers can be customized with respect to font and placement. Both the header and footer have separate tabs as shown below. Once the desired profile is created, it can be saved for use every time the particular data file is opened.

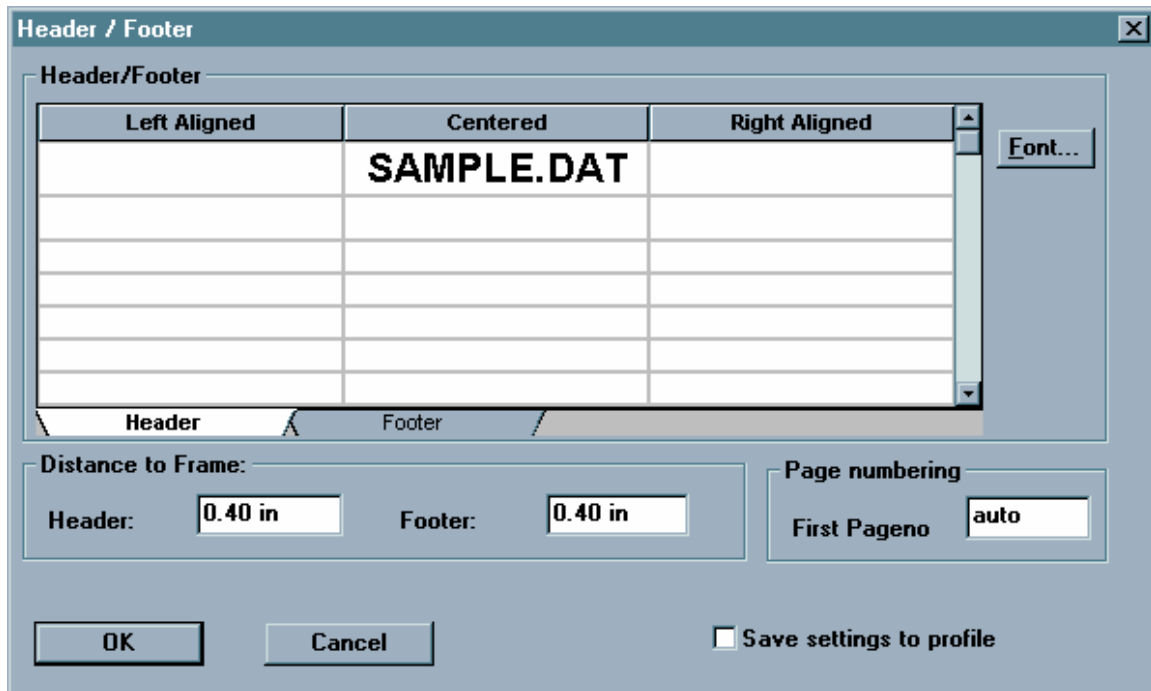

4.3.2 EDIT

The edit menu appears whenever a data file is opened in EcoWatch. It allows you to locate, format, and manage data.

COPY

Copies the selection to the clipboard. If a graph or table is active, then choosing this command will send its contents to the Windows clipboard so that it can be pasted into other programs. This is a normal method of transfer data between different Window programs.

Copying data to the clipboard replaces the contents previously stored there.

Shortcuts

Toolbar: 
 Keys: CTRL+C

PASTE

This command does not function in this version of EcoWatch.

REMOVE PARAMETERS

When entire column(s) of data is selected, including the heading(s), this command will remove the parameter(s) from both the data table and graph.

INSERT PARAMETER

Adds an additional parameter to the data table and graph. All available parameters that can be added are shown on a list.

FIND

Locates text within the selected parameter. Only one parameter may be searched at a time. A system beep indicates that there are no more occurrences of the desired text.

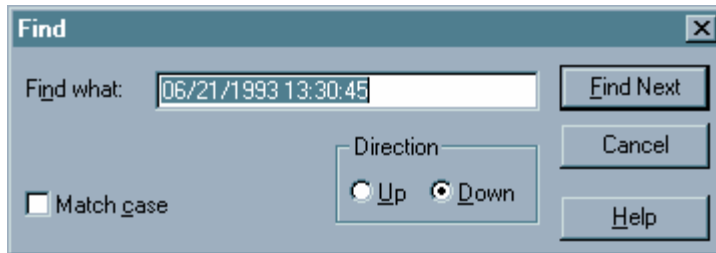

FIND AGAIN

Locates the text that was most recently searched for within the selected parameter. Only one parameter may be searched at a time.

4.3.3 VIEW

The **View** menu offers the following commands:

TOOLBAR

Use this command to display and hide the **Toolbar**, which includes buttons for some of the most common commands in EcoWatch, such as **File Open**. A check mark appears next to the menu item when the **Toolbar** is displayed.



Shortcut: To hide or display the Toolbar, choose **Toolbar** from the **View** menu.

See **Section 4.2.6, Using the Toolbar**, for a list of the toolbar icons and their functions.

STATUS BAR

Use this command to display and hide the **Status Bar**, which describes the action to be executed by the selected menu item or statuses of keyboard latch state. A check mark appears next to the menu item when the **Status Bar** is displayed.



The right areas of the status bar indicate which of the following keys are latched down:

CAP	The Caps Lock key is latched down.
NUM	The Num Lock key is latched down.
SCRL	The Scroll Lock key is latched down.

4-DIGIT YEAR

Use this command to toggle between a date with a two or four digit year on the graph and table.

GRAPH

Use this command to display and hide the **Graph** page when viewing a file. The graph page contains plots of data.

Shortcuts

Toolbar:



TABLE

Use this command to display and hide the **Table** page while viewing a data file.

Shortcuts

Toolbar:



GRID

Turns on or off the gridlines on graphs.

MARKERS

Turns on or off data point markers on the graphs. For graphs with more than a few data points we recommend that **Markers** be left off.

STATISTIC

This command will display statistics for the current study. It will show the minimum, maximum, mean, and standard deviation for each of the current parameters. If you click on any minimum or maximum value, then a small box will appear showing the date and time when the minimum or maximum point occurred.

Statistic				
4315 Samples				
From (06/08/94 15:52) To (07/23/94 14:22)				
	Min	Max	Mean	Std
Temp (C)	19.85	32.05	25.67	2.459
Sp Cond (mS/cm)	0.01	1.02	0.86	0.057
DO Conc (mg/L)	0.16	15.14	3.07	3.286
pH ()	6.79	7.77	7.27	0.127
Depth (ft)	0.93	2.84	2.32	0.236

ShortcutsToolbar: **STUDY INFO**

This command will display a dialog box describing the study. It will show the sonde type and serial number that was used to collect the data, the parameters available, the logging interval, and the beginning and ending times of the sample.

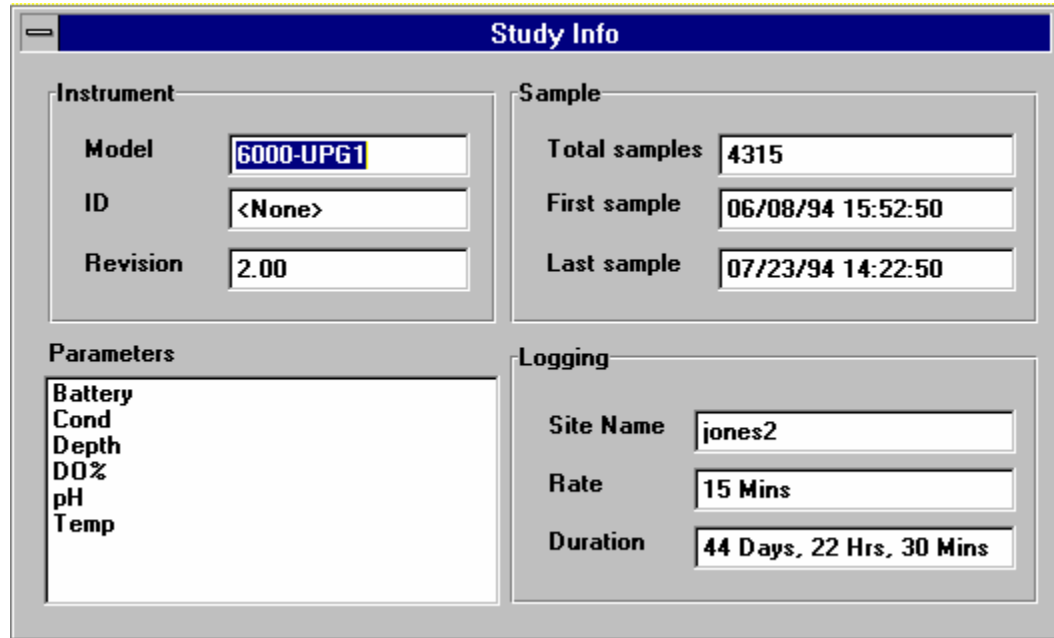

Study Info	
Instrument	Sample
Model: 6000-UPG1	Total samples: 4315
ID: <None>	First sample: 06/08/94 15:52:50
Revision: 2.00	Last sample: 07/23/94 14:22:50
Parameters	Logging
Battery Cond Depth DO% pH Temp	Site Name: jones2
	Rate: 15 Mins
	Duration: 44 Days, 22 Hrs, 30 Mins

ShortcutsToolbar: **ZOOM IN**

Enlarges graph or data table (whichever is currently active) by 20%.

ShortcutsToolbar: **ZOOM OUT**

Reduces graph or data table (whichever is currently active) by 20%. If the graph already extends to both ends of the **Study Limits**, then it is not possible to zoom out any farther and this command will be dimmed.

ShortcutsToolbar: 

UNZOOM

Displays the graph all the way to both ends of the **Study Limit** if a graph is selected. Displays the data table in default size, if a data table is selected.

Shortcuts

Toolbar: 

4.3.4 COMM(UNICATION)

The **Comm** (Communications) menu commands let you control your communications settings with sondes, modems, and other devices. Several communication menu options are only available when a terminal window is opened.

SETTINGS

The **Communications Settings** dialog box is where you can configure the communications ports. The settings are organized into the following three tabs.

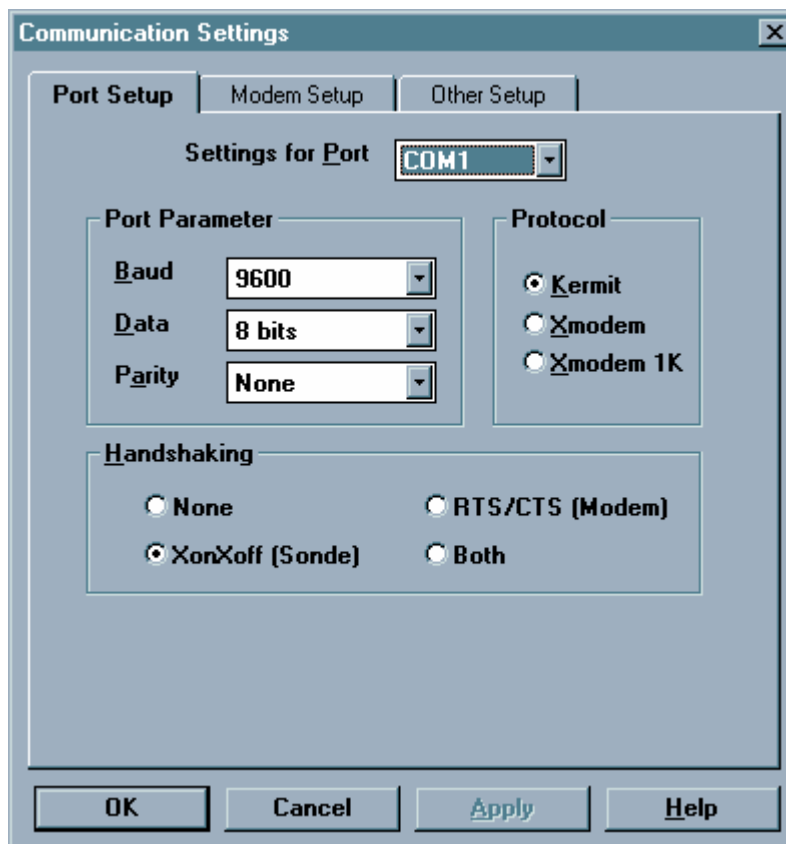

Port Setup

This is where you can set port parameters, file transfer protocol and handshaking for each of the ports that you will use.

- **Port Parameter Setup**
These include the most common settings for each communication port. These settings are **Baud Rate**, number of **Data** bits, and **Parity**. These settings must be identical to the settings on the device that is connected to the port. You may choose independent settings for each communication port.
- **Protocol**
You may choose **Kermit**, **Xmodem** or **Xmodem 1K** protocol for file transfer through the communications port. 6820, 6920, 600R, 600XL, 600XLM and 6600 sondes use only **Kermit** protocol.
- **Handshaking**
You may choose **Xon/Xoff**, or **RTS/CTS**, or **Both** or **None**. **Xon/Xoff** is often referred to as software handshaking and RTS/CTS as hardware handshaking. If you are using a YSI sonde select **Xon/Xoff**. Modems usually require **RTS/CTS**.
- **Modem Setup**
This is where you enter the settings for your modem. Note that you can have several modems, each on separate COM ports, and each with its own settings.

If a modem is selected for a particular COM port, then every time that port is opened, EcoWatch will attempt to initialize a modem on that port. If the attempt fails, then EcoWatch will open a terminal window and you can communicate to that port with the computer keyboard. This can be very helpful in troubleshooting a connection to your modem or in determining exactly which settings work with your modem.

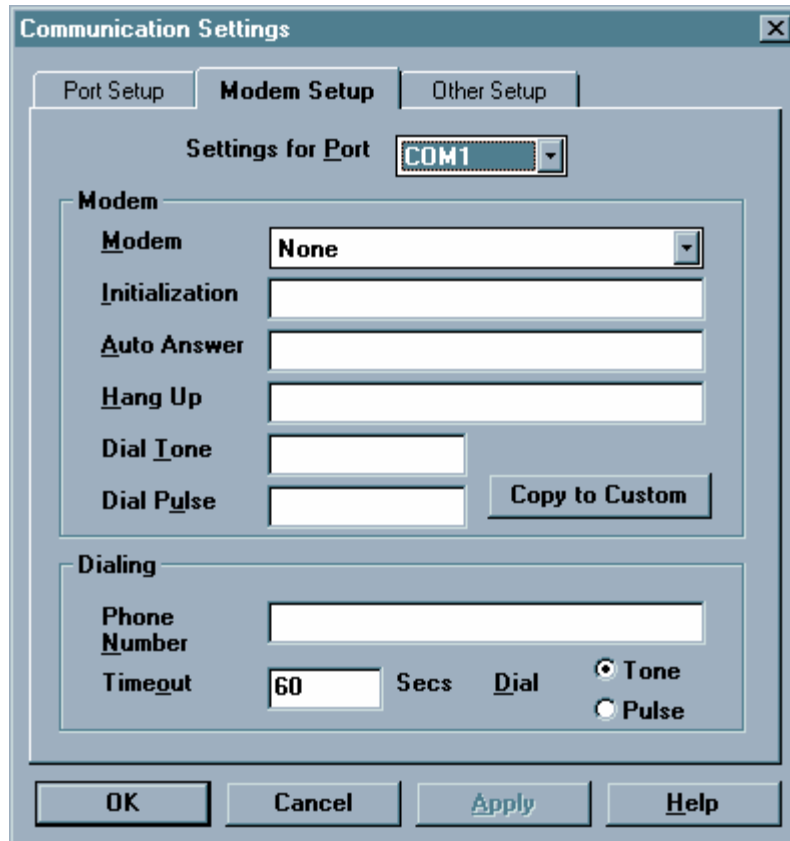

- **Modem**
To setup a particular modem on your first try, select that modem from the **Modem** list. The only settings that you can edit are for the **Custom** modem.

If your modem does not work, select “Hayes Compatible” modem. Those settings are quite common and might work for your modem. If neither approach works, then you will have to define your own settings. You will need the instruction manual for your modem. It should list all of the proper settings. Choose **Custom** from the **Modem** list and enter the settings for your modem.

The **Auto Answer** setting is included in the dialog for completeness. EcoWatch currently does not use **Auto Answer**.
- **Copy to Custom**
The **Copy to Custom** button is sometimes helpful in defining your own settings. If there is a similar modem, choose it from the list, and then click **Copy to Custom**. Choose **Custom** from the list and edit the settings. It transfers all modem settings from the currently selected modem to the “Custom” modem so you can modify the setting later.
- **Dialing**
If there is no entry for **Phone Number**, then every time you choose an option that opens the COM port that connected to a modem, EcoWatch will ask you for a phone number. **Timeout** specifies how long in seconds EcoWatch will wait for the phone to answer. Use the **Dial** option to select **Tone** or **Pulse** dialing.

Other Setup

This is where you choose a default port for communicating with a sonde and default capture files for each sonde port. This tab addresses several COM port settings not covered on the other two tabs.

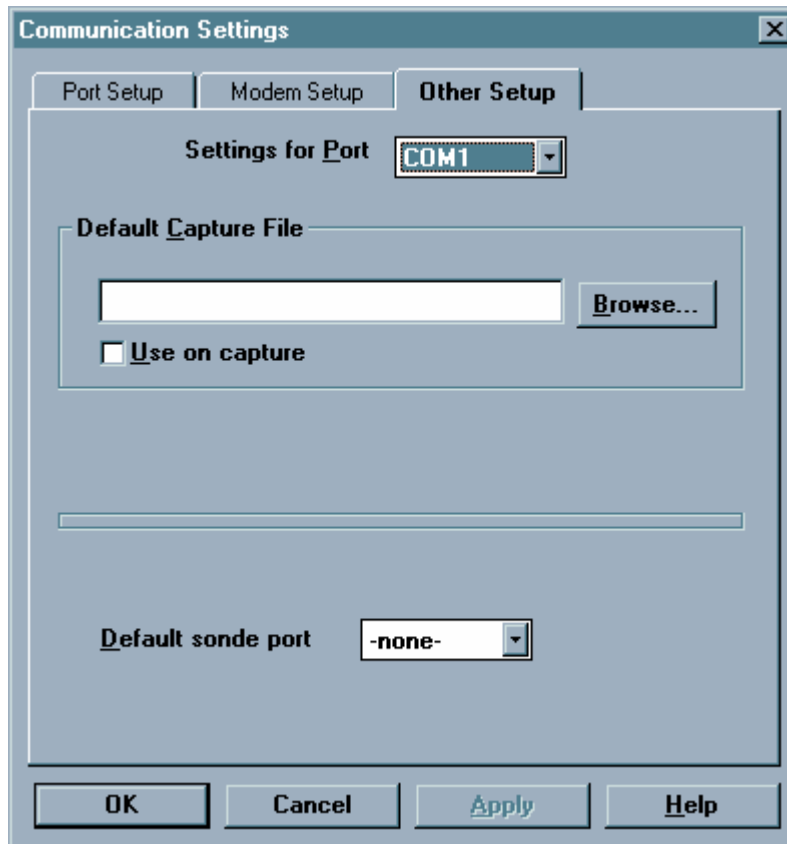

- **Default Capture File**

While communicating to a sonde in terminal mode using the Sonde command, you may want to capture measurements to a file. You may type in a default file name in the accompanying text box.

If you specify a file name here and select the Use on Capture check box, then whenever you capture data, the program will write to that file without first asking you to confirm. If you specify a file but do not select the check box, then you will have to confirm that this is the file you wish to have your data written to before starting to capture.

- **Default Sonde Port**

This refers to the COM port you will most commonly use to connect to your sonde. If you select a port here, EcoWatch will automatically use this port as the default COM port when you use the Sonde command.

The **Apply** button in the bottom of this dialog box is not used in EcoWatch.

SONDE

This command opens a terminal window for communicating with a sonde. From the terminal window you can communicate to a sonde using the sonde menus. Unless you have chosen a default sonde port in the

Communications Settings dialog box the following dialog box will appear asking you which COM port to use.

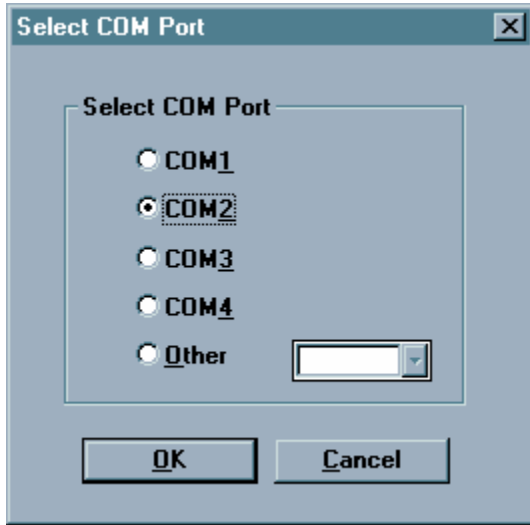

Shortcuts

Toolbar: 

TERMINAL

Opens a new terminal window for communicating with any compatible RS-232 devices.

FONT/COLOR

Adjust font color, size, and style for any text that appears in the terminal window.

BACKGROUND COLOR

Adjust the background color of the terminal window.

CAPTURE

Turns COM port capture **On** or **Off**. This is typically used while communicating with a sonde that is taking measurements. Capture will send all communications received on the COM port to a file. After selecting the command, a dialog box will appear for selecting the name of the file to use. If “Use default capture” file was checked in Communications Settings, EcoWatch will not display this dialog.

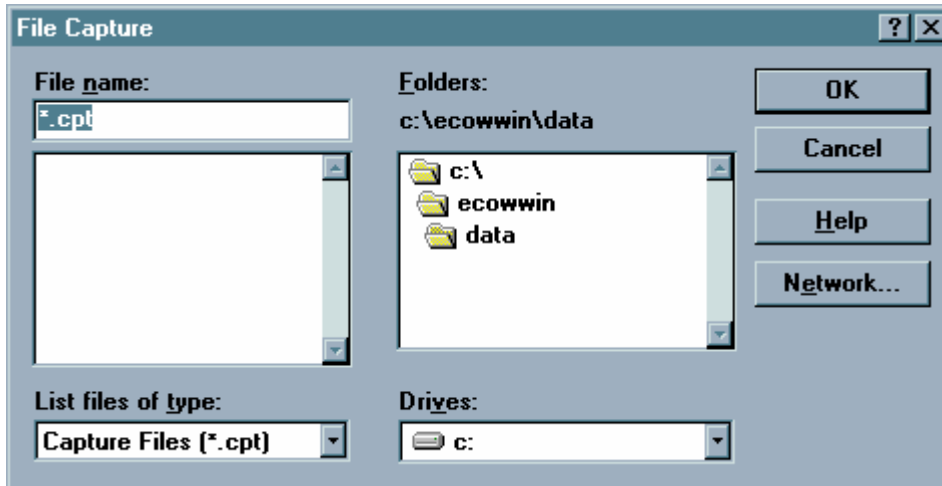

A common example is using a sonde in **Run Mode**. The sonde is simply taking readings and sending them to the COM port. If you want to keep a record of these readings, then a simple way to do so is to turn **Capture** on. When you are finished, run the **Capture** command again to turn it off.

FILE UPLOAD

Use this command to upload files from any device that uses **Xmodem** file transfer protocol. First initiate the upload from the device, then choose this command. This command is enabled only when the **Xmodem** or Xmodem 1K protocol has been selected in **Port Setup**.

DIAL MODEM

If you have specified a default phone number in the **Modem** tab of the communications **Settings** dialog box, then this command will call that number. If you have not specified a default number, then you will be asked for a number.

HANG-UP MODEM

Hangs up phone and halts communication with the modem.

SEND ASCII FILE

Sends a file in to the device connected to the terminal using plain ASCII protocol. No handshaking or error correction is involved.

SEND XMODEM FILE

Sends a file to the device connected to the terminal using **XModem** protocol.

4.3.5 REAL-TIME

The **Real-time** menu offers the following commands that allow you to control how your data will be presented.

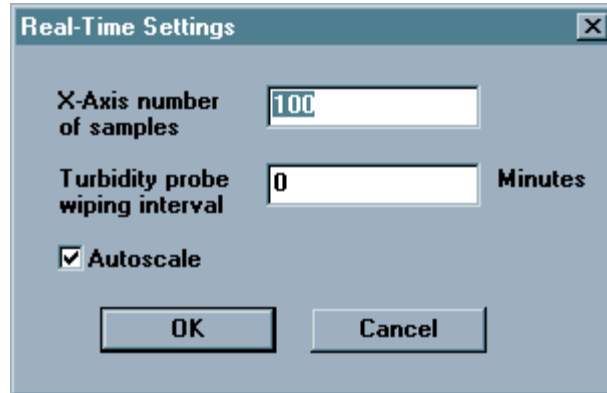

SETTINGS

This command is only active when there is a real-time window open. This command takes you to the **Real-time Settings dialog** where you can set the length of the x-axis.

In the Real-Time Settings box you will set the number of samples graphed across the axis. (The interval between samples is set in the sonde using the sonde menus.) After the graph is full, each new data point will cause the trace to scroll left so that you see only the most recent set of measurements.

If you have a YSI 6026 or 6136 turbidity, 6025 chlorophyll, or 6130 rhodamine WT probe with a wiper, then you may want to clean the optics periodically. Set that interval in this dialog.

Autoscaling will keep the trace comfortably on the graph as the measurement changes.

To **Manually Scale** a graph; double-click on its Y-axis labels. The Graph Y-Axis box will come up where you can set the scale. Note that you can manually set the scale for some parameters and autoscale others. When the autoscale box is checked, the high and low limits will be unavailable. See also the **Autoscale** command in the **Graph** menu.

NEW

Choose this to start a new real time study.

OPEN

Choose this to open a previous real time study.

CLOSE

Choose this to close a real time study.

Two files are formed every time a real time study is started. You will choose a .RT file that will store colors, scaling information, number of parameters and other information useful to the program. At the same time, the program starts another file with the same name but a .DAT extension for the actual measurements that are taken during the study.

4.3.6 GRAPH

ZOOM WINDOW

Enlarges a section of the graph. The pointer will change to a magnifying glass and then you can click and drag on the graph to indicate the section you want to view. This command stays active until you execute it again.

Shortcuts

Toolbar: 

CENTER SCROLL

Centers graph at the mouse cursor. The pointer will change to a bullseye. Clicking anywhere on the graph will cause that point to be moved to the center. This command stays active until you execute it again.

Shortcuts

Toolbar: 

LIMIT DATA SET

This command limits the amount of data being processed. If you are not presently interested in portions of the graph or table at the beginning or end of the study, you may want to use this command to indicate only that portion that you are interested in. The program will have fewer data points to handle and will respond to your commands quicker. Executing this command when modifying a graph will change the pointer to a vertical arrow. Click once on the left end of that part of the graph that you want and then click again at the right end. This command stays active until you execute it again.

To limit the data in a table, move the pointer to the far left of the table into the row numbers area and highlight from the desired cutoff point to the beginning or end of the data set, whichever is desired. Then select the **Limit Data Set** option from the graph menu or use the toolbar shortcut.

To undo the limits choose **Cancel Limits** below. Alternately, you may remove the limits on a graph by executing this command backwards. That is, click anywhere on the right side of the graph first, and then click anywhere on the left side. The limits will be moved to the ends of the file.

Shortcuts

Toolbar: 

AUTOSCALE

Sets the scale of each parameter so that the minimum and maximum points fit comfortably on the graph.

MANUAL SCALE

Takes you to the **Graph Y-Axis** dialog box where you can set the scale for each parameter.

Graph Y-axis dialog box

To manually scale a graph, double click on its Y-axis labels. A dialog will come up where you can set the scale. Note that you can manually set the scale for some parameters and autoscale others. When the autoscale box is checked, the high and low limits will be dimmed. See also the Autoscale command in the Graph menu.

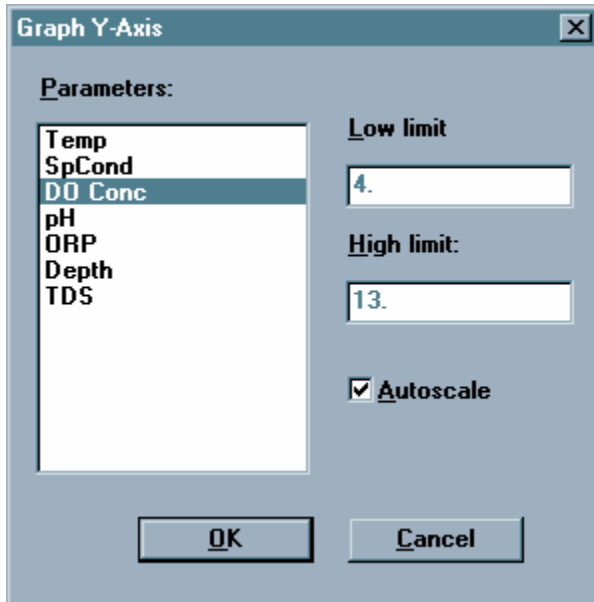

REDRAW

If part of a graph is not displayed it could be because your window is sized too small to display it or because you have just returned to EcoWatch from some other application. Maximizing the window and choosing this command should display your graph correctly

Shortcuts

Toolbar: 

CANCEL LIMITS

Choose this command to cancel the limits set by the **Limit Data Set** command.

4.3.7 SETUP

PARAMETER

Lets you select which parameters you want to analyze and how they will appear.

Add/Remove

There are two lists, **Selected Parameters** and **Available Parameters**. If, for example, you wish to graph another parameter, you must highlight it on the **Available Parameter** list and then click the Add button to move it over to the **Selected Parameters** list.

This is also where you decide the order in which the parameters will appear in both the table and the graphs. If you choose to have two traces per graph, then the first graph will have the first and second parameters on this list, the second graph will have the third and fourth parameters and so forth. The parameters will appear in the **Selected Parameters** list in the order that they were added. To rearrange the order, highlight the parameter you wish to move and then use the up and down buttons to move it to the desired spot in the order.

The **TSS parameter** (only available if your sonde has a Turbidity sensor) is a parameter that is not part of your original collected data. TSS is calculated by EcoWatch, which uses the Turbidity data and a set of correlation points that you enter. When you add TSS, a TSS calibration window will popup and prompt you for a set of correlation points. For more information see **Calibrate TSS**.

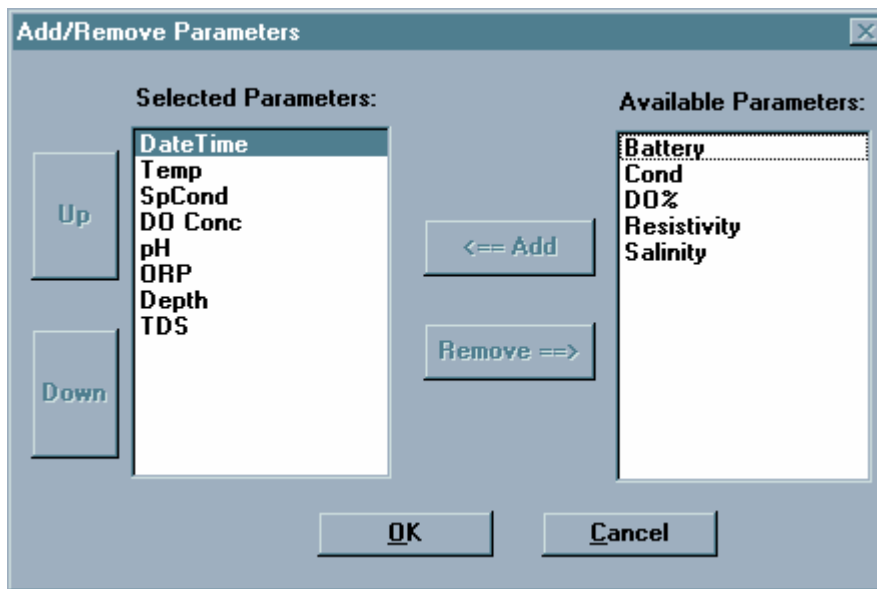

Units

Select the units for any parameter. It will take you to the **Change Parameter Units** dialog box. You may choose the units for each of the selected parameters. Many parameters have only one possible choice of units. DO concentration, for example; can only be expressed in mg/L. pH has no units at all.

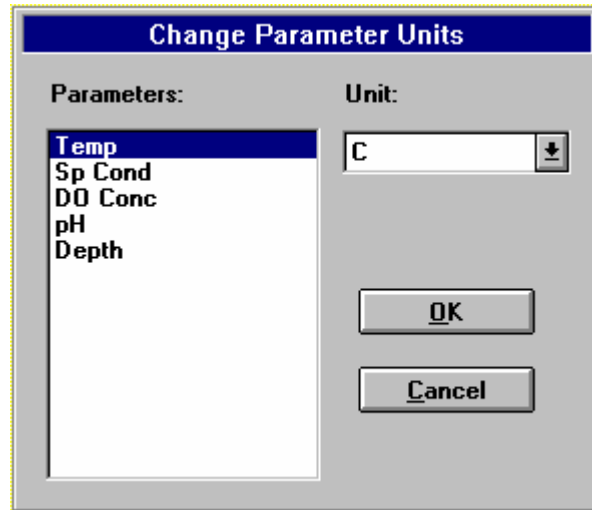

Attributes

This command takes you to the **Change Parameter Attributes** dialog box where you have access to two powerful features. You can choose to display an average of your data, or graph the data with some parameter other than time for the x-axis. The most common use for this latter feature is to graph temperature and DO versus depth. Other combinations are possible. You may choose to average the data before it is graphed. An interval of 0 will cause there to be no averaging at all. The larger the averaging interval, the more points will be used in each average. For example, if you acquired data every 15 minutes and you set the average interval to 60 minutes, each set of four points will be averaged and then plotted as a single point. This feature will not only smooth a graph, but will also reduce the amount of data exported that is sometimes convenient when exporting to a spreadsheet.

The x-axis parameter is normally **Time**, but you can choose any parameter you like. By default, data files are sorted by increasing time. If you have chosen another parameter for the x-axis, then you may want to have the data sorted before graphing it.

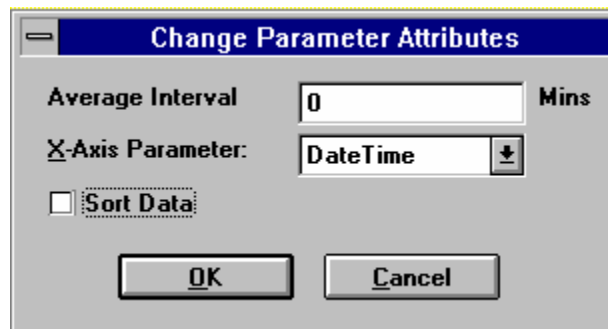

Change name

This command takes you to the **Define Parameter Name** dialog box where you may change the default names of the parameters.

This dialog is intended to make changes like "degrees Celsius" to "degrees C". If you change "degrees Celsius" to "degrees Fahrenheit", then the data displayed will be in degrees Celsius even though the graph says "degrees Fahrenheit." To change the units for that parameter, use the **Change Parameter Units** dialog box.

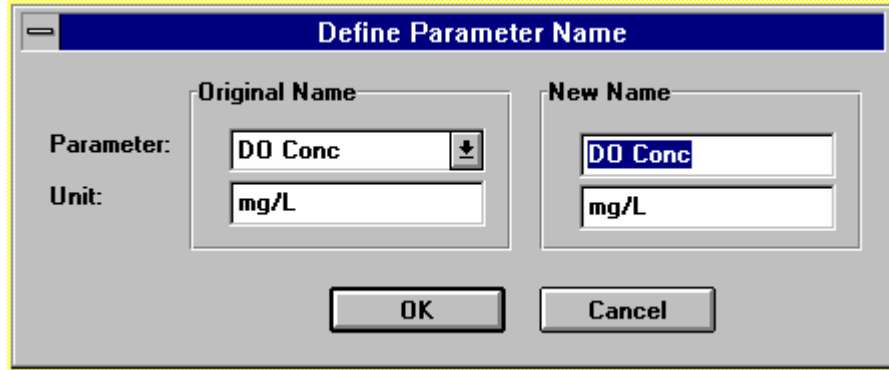

Calibrate TSS

TSS is an abbreviation for Total Suspended Solids. TSS is a unit derived from a Turbidity (NTU) measurement and correlated TSS-NTU measurements. The Calibrate TSS feature is only used if the TSS parameter has been added to the current data file using **Add/Remove Parameters**. This command opens the TSS Calibration window and allows calibration adjustment.

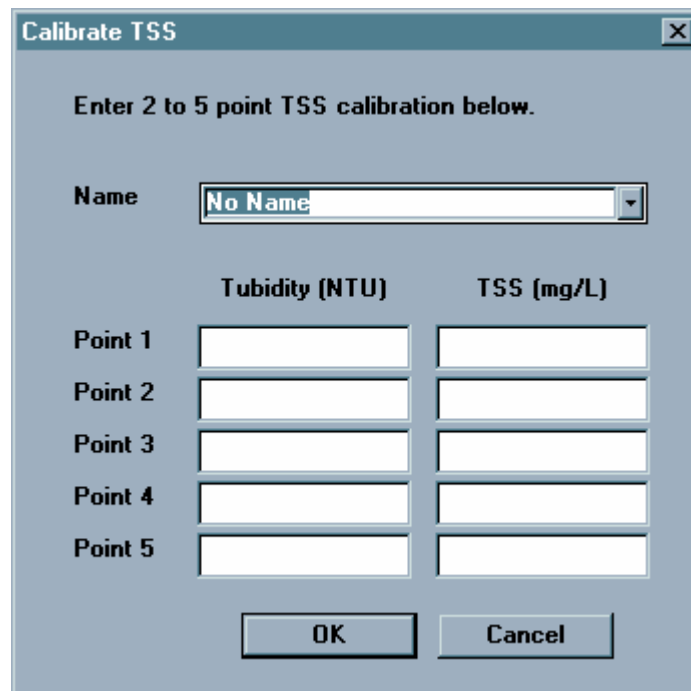

How do I add TSS to my data file?

You must have a data set that includes Turbidity data points.

It is also common to use a 0 to 0 correlation as a base point in these measurements. This can be used as the first correlation point. You need to establish a correlation between your Turbidity reading and a TSS value. This is done by taking a sample and noting its Turbidity in NTU's. Then run a lab analysis to obtain a total suspended solids reading. You have now determined one correlation point.

Once you have at least two correlation points, you have established a linear correlation between the two measurements. EcoWatch allows you to enter up to five correlation

points. The more correlation points you have, the higher that your accuracy will be.

To add the TSS parameter to your data file, go to the **Setup** menu. Choose **Parameters**, then **Add/Remove**. Select the **TSS** parameter and click the **Add** button. The Calibrate TSS window will appear.

Name the file for identification in the future. Multiple calibration files may be created. Any previously created calibration files will be located in the drop-down name list box.

Once you have entered the desired number of correlation points, click **OK**. EcoWatch will calculate the TSS values by doing a linear interpolation of the Turbidity (NTU) data and the correlation chart .

GRAPH

The **Setup** menu, **Graph** submenu has the following commands:

Font/Color

Goes to the **Font Dialog Box** where you can change the font and color of text that appears in the graph.

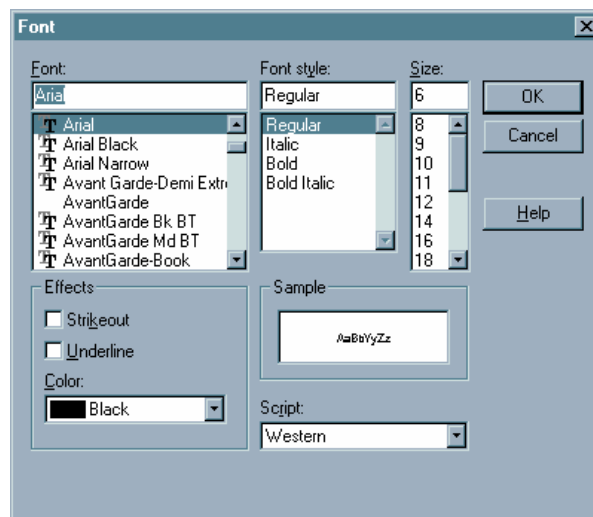

- **Font**
Type or select a font name. EcoWatch lists the fonts available with the current printer driver and additional fonts installed in your system.
- **Font Style**
Select a font style. To use the default type style for a given font, select Regular.
- **Size**
Type or select a font size. The sizes available depend on the printer and the selected font. If the size you type is not available on the current printer, EcoWatch chooses the closest available size.
- **Effects**
Choosing **Strikeout** will draw a line through all text in the table. Choosing underline will underline the text.
- **Color**

Type or select one of the 16 predefined colors. To display color, you must have a color monitor; to print color, you must have a color plotter or a color printer.

- **Sample**
Shows the effects of the formatting you specify before you apply it to the document.

Page Color

Goes to the **Color Dialog Box** where you can change the color of the graph page. This is the background for all of the graphs rather than the background for each individual graph that is set with the next command.



Trace Color

Goes to the **Change Trace Color** dialog box where you can change the color of the trace and the background for each of the individual graphs. For setting the background color for all graphs, see the previous command.

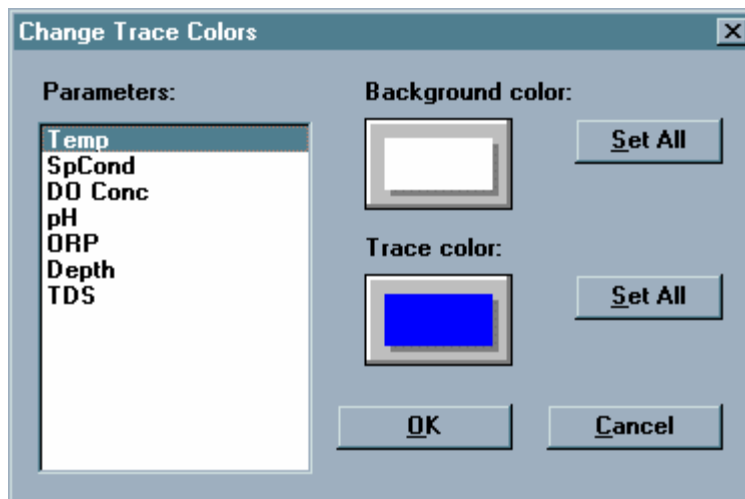

Note that there are two color buttons, one for the trace color and the other for the background color. Clicking on either of these buttons will take you to the **Color** dialog box where you can change the color.

Use the **Set All buttons** to quickly set all traces or backgrounds to the same color.

Page Title

This is where you can enter a title for the graph. The title may have one or two lines.

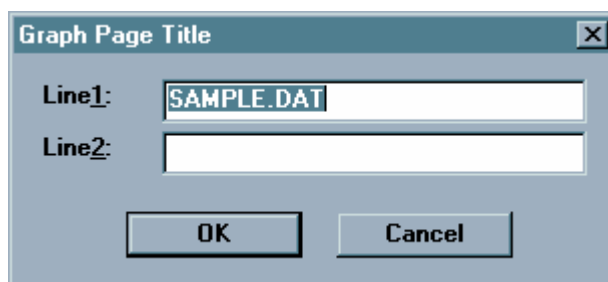

1 Trace per Graph

Choose this to have just one parameter on each graph.

2 Traces per Graph

Choose this to have two parameters on each graph.

TABLE

If there is no table, then the commands on this submenu will be unavailable. The Table submenu offers the following commands:

Font/Color

Goes to the Font Dialog Box where you can change the font and color of text that appears in the table.

Page Color

Goes to the Color Dialog Box where you can change the color of the table background color. That is the part of the table where the readings appear.

Highlight Color

Goes to the Color Dialog Box where you can change the color of the table highlight color. That is the part of the table where the reading units appear.

SET DEFAULT TEMPLATE

This option allows you to select display parameters for your data when you initially open a file in EcoWatch. Display parameters include background and trace colors on your graph, which parameters are displayed, parameter ordering, parameter units, and scaling of those parameters (either manual or automatic). The first time you use EcoWatch with a data file, graphing will proceed according to the default settings present in EcoWatch. For example, graph backgrounds will all be black, traces will be plotted each with a different color, all parameters will be auto-scaled, and if your sonde measures conductivity and dissolved oxygen, EcoWatch will display specific conductance in mS/cm and dissolved oxygen in mg/L. You can change the default settings by using **Set Default Template**.

- 1 - Open a data file and observe the presentation of the data in graphic and tabular form.
- 2 - You can change the background and trace colors by going into the **Graph** and/or **Table submenus** of the **Setup Menu**.
- 3 - You can add or remove parameters by going into the **Parameter submenu** of the **Setup Menu**.
- 4 - You can change the units of the displayed parameters by going into the Parameter submenu of the Setup Menu.
- 5 - You can change the order of the parameters by going into the **Add/Remove Parameters dialog box** in the **Parameter submenu** of the **Setup Menu**.
- 6 - You can set the scaling options for your data by double-clicking on the Y-axis of the graph and using the **Graph Y-Axis dialog box** to set the scales.
- 7 - After setting the display parameters enter the **Setup Menu** and choose **Set Default Template**. Now every data file that you initially open will use the display parameters that you have chosen. If you want to delete your template, enter the **Setup Menu** and choose **Clear Default Template**.

CLEAR DEFAULT TEMPLATE

This command will eliminate a default template that has been saved. With no default template, all new EcoWatch files open in whatever form they were saved in.

4.3.8 APPL(ICATIONS)

The **Appl** menu is the link to other Application programs that can be used with EcoWatch. For Help using a GIS software, consult the menu that came with the GIS system.

To upload from a Campbell Scientific CR10 Logger, first connect the logger to a COM port using a Campbell Scientific SC32A Adapter. Set the port for 9600 Baud, 8 data bits, no parity and Xon/Xoff handshaking. Then from the EcoWatch **Appl** menu, select **CR10 Upload**. The dialog box below will appear.

The items Number of Filled Locations and DSP Locations are information from the logger that you cannot change. FS Area, First Upload Location, and Number of Arrays to Upload are fields that you must enter. Refer to your CR10 manual for instructions.

Select a destination file (under Upload File; use the Browse button as needed) and click Upload.

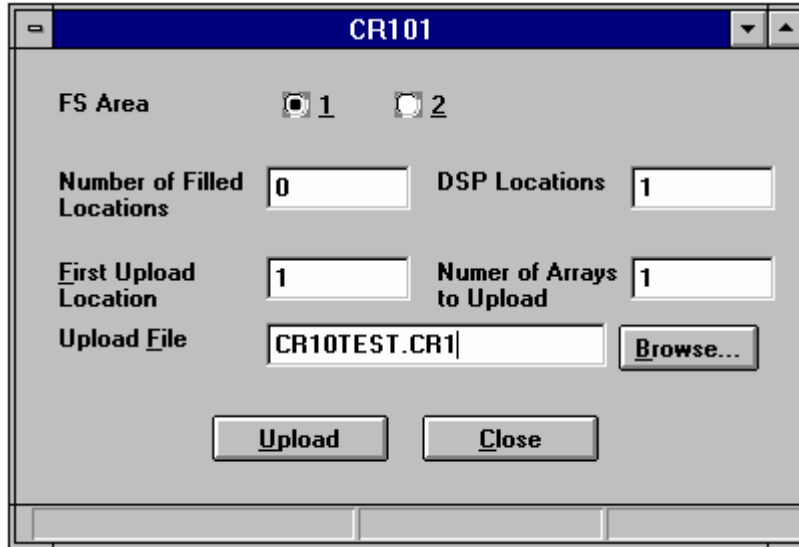

4.3.9 WINDOW

The Window menu offers the following commands that enable you to arrange multiple views of multiple documents in the application window:

CASCADE

Use this command to arrange multiple opened windows in an overlapped fashion

TILE HORIZONTAL

Use this command to vertically arrange multiple opened windows in non-overlapped horizontal tiles.

TILE VERTICAL

Use this command to arrange multiple opened windows side by side.

ARRANGE ICONS

Use this command to arrange the icons for minimized windows at the bottom of the main EcoWatch window. If there is an open document window at the bottom of the main window, then some or all of the icons may not be visible because they will be underneath this document window.

WINDOW 1, 2...

EcoWatch displays a list of currently open document windows at the bottom of the Window menu. A check mark appears in front of the document name of the active window. Choose a document from this list to make its window active.

4.3.10 HELP

The Help menu offers the following commands, which provide you assistance with this application:

CONTENTS

Offers you a list of the available Help topics.

USING HELP

Use this command for instructions about using Help.

TECHNICAL SUPPORT

YSI Technical support phone number.

ABOUT

Displays the version number of this application.

SECTION 5 PRINCIPLES OF OPERATION

5.1 CONDUCTIVITY

The sondes utilize a cell with four pure nickel electrodes for the measurement of solution conductance. Two of the electrodes are current driven, and two are used to measure the voltage drop. The measured voltage drop is then converted into a conductance value in milli-Siemens (millimhos). To convert this value to a conductivity value in milli-Siemens per cm (mS/cm), the conductance is multiplied by the cell constant that has units of reciprocal cm (cm⁻¹). The cell constant for the sonde conductivity cell is approximately 5.0/cm. For most applications, the cell constant is automatically determined (or confirmed) with each deployment of the system when the calibration procedure is followed. Solutions with conductivities of 1.00, 10.0, 50.0, and 100.0 mS/cm, which have been prepared in accordance with recommendation 56-1981 of the Organization International De Metrologie Legale (OIML), are available from YSI. The instrument output is in mS/cm or uS/cm for both conductivity and specific conductance. The multiplication of cell constant times conductance is carried out automatically by the software.

CALIBRATION AND EFFECT OF TEMPERATURE

The conductivity of solutions of ionic species is highly dependent on temperature, varying as much as 3% for each change of one degree Celsius (temperature coefficient = 3%/°C). In addition, the temperature coefficient itself varies with the nature of the ionic species present.

Because the exact composition of a natural media is usually not known, it is best to report a conductivity at a particular temperature, e.g. 20.2 mS/cm at 14 °C. However, in many cases, it is also useful to compensate for the temperature dependence in order to determine at a glance if gross changes are occurring in the ionic content of the medium over time. For this reason, the sonde software also allows the user to output conductivity data in either raw or temperature compensated form. If Conductivity is selected, values of conductivity that are *NOT* compensated for temperature are output to the report. If Specific Conductance is selected, the sonde uses the temperature and raw conductivity values associated with each determination to generate a specific conductance value compensated to 25°C. The calculation is carried out as in equation (1) below, using a temperature coefficient of 1.91%/°C (TC = 0.0191):

$$\text{Specific Conductance (25°C)} = \frac{\text{Conductivity}}{1 + \text{TC} * (\text{T} - 25)}$$

As noted above, unless the solution being measured consists of pure KCl in water, this temperature compensated value will be somewhat inaccurate, but the equation with a value of TC = 0.0191 will provide a close approximation for seawater and for solutions of many common salts such as NaCl and NH₄Cl.

MEASUREMENT AND CALIBRATION PRECAUTIONS

- 1 - When filling the calibration vessel prior to performing the calibration procedure, make certain that the level of calibrant standard is high enough in the calibration cup or beaker to cover the entire conductivity cell.
- 2 - After placing the sonde in the calibration solution, agitate the sonde to remove any bubbles in the conductivity cell.
- 3 - During calibration, allow the sensors time to stabilize with regard to temperature (approximately 60 seconds) before proceeding with the calibration protocol. The readings after calibration are only as good as the calibration itself.

4 - Perform sensor calibration at a temperature as close to 25°C as possible. This will minimize any temperature compensation error.

5.2 SALINITY

Salinity is determined automatically from the sonde conductivity and temperature readings according to algorithms found in *Standard Methods for the Examination of Water and Wastewater* (ed. 1989). The use of the Practical Salinity Scale results in values that are unitless, since the measurements are carried out in reference to the conductivity of standard seawater at 15 °C. However, the unitless salinity values are very close to those determined by the previously used method where the mass of dissolved salts in a given mass of water (parts per thousand) was reported. Hence, the designation “ppt” is reported by the instrument to provide a more conventional output.

5.3 TOTAL DISSOLVED SOLIDS (TDS)

The electrical conductivity of environmental water is due to the presence of dissolved ionic species. Thus, the magnitude of the conductivity (or specific conductance) value can be used as a rough estimate of amount (in g/L) of these ionic compounds which are present. The 6-series software provides a conversion from specific conductance to total dissolved solids (TDS) by the use of a simple multiplier. However, this multiplier is highly dependent on the nature of the ionic species present. To be assured of even moderate accuracy for the conversion, the user must determine this multiplier for the water at the site of interest. Use the following protocol to determine the conversion factor:

1. Determine the specific conductance of a water sample from the site;
2. Filter a portion of water from the site;
3. Completely evaporate the water from a carefully measured volume of the filtered sample to yield a dry solid;
4. Accurately weigh the remaining solid;
5. Divide the weight of the solid (in grams) by the volume of water used (in liters) to yield the TDS value in g/L for this site; Divide the TDS value in g/L by the specific conductance of the water in mS/cm to yield the conversion multiplier. Be certain to use the correct units.
6. Enter the determined constant into the sonde software from the Advanced|Sensor menu to view the correct TDS values from a computer/sonde interface.

CAUTION: The default value (0.65) for conversion of specific conductance in mS/cm to TDS in g/L which is resident in the Advanced|Sensor menu of the software is only useful for a gross estimate of the TDS. As noted above, to attain any degree of accuracy for TDS, the user must determine the conversion factor empirically. Even then, if the nature of the ionic species at the site changes during an unattended study or between sampling studies, the TDS values will be in error. It is important to recognize that, generally speaking, TDS cannot be calculated accurately from specific conductance unless the make-up of the chemical species in the water remains constant.

NOTE: EcoWatch for Windows contains a conversion factor of 0.65 for conversion of specific conductance in mS/cm to TDS in g/L. However, unlike the sonde software, this constant cannot be varied in EcoWatch. Thus, to calculate TDS from data resident in an EcoWatch file, the user should export the specific conductance readings to a spreadsheet and carry out the calculation there using the formula:

TDS in g/L = (Sp. Cond in mS/cm) x (User-Derived Constant)

5.4 OXIDATION REDUCTION POTENTIAL (ORP)

The sondes determine the Oxidation Reduction Potential (ORP) of the media by measuring the difference in potential between an electrode which is relatively chemically inert and a reference electrode. To measure ORP with a sonde, a combination pH/ORP probe must be in place in the sonde bulkhead and ORP must be accessed via the ISE2 channel of the sonde. The ORP sensor consists of a platinum button found on the tip of the probe. The potential associated with this metal is read versus the Ag/AgCl reference electrode of the combination sensor that utilizes gelled electrolyte. ORP values are presented in millivolts and are not compensated for temperature.

CALIBRATION AND EFFECT OF TEMPERATURE

Calibration may not be required for the ORP sensor of the sonde when it is new. However, older probes that have been deployed extensively may show some deviation from the theoretical ORP value. This deviation is usually due to a change in the concentration of the KCl in the reference electrode gel. To determine whether the sensor is functioning correctly, place the ORP probe in 3682 Zobell solution and monitor the millivolt reading. If the probe is functioning within specifications, the ORP reading should be within the range of 221-241 at normal ambient temperature. If the reading is outside of this range, the probe can be calibrated to the correct value (231 mV at 25°C) using the calibration procedure outlined in **Section 2.6.1, Calibration**.

ORP readings for the same solution can vary up to 100 mv depending on the temperature. However, no standard compensation algorithms exist for this parameter. Be sure to take this factor into account when reporting ORP values and checking sensor calibration. For Zobell solution, consult the following chart:

TEMPERATURE, CELSIUS	ZOBELL SOLUTION VALUE, MV
-5	270.0
0	263.5
5	257.0
10	250.5
15	244.0
20	237.5
25	231.0
30	224.5
35	218.0
40	211.5
45	205.0
50	198.5

MEASUREMENT AND CALIBRATION PRECAUTIONS

1 - Instructions for preparation of ORP calibrator solutions (including Zobell reagent) can be found in Section 2580 A. of *Standard Methods for the Examination of Water and Wastewater*. Alternatively, the Zobell solution is available from YSI.

2 – Reagents to confirm ORP sensitivity are available. Contact YSI Customer Service for ordering information.

3 - ORP readings usually stabilize much more rapidly in standards (e.g., Zobell solution) than in most environmental water. Be certain to consider this factor when determining ORP in field studies.

4 - Clean and store the pH/ORP sensor by following the instructions in **Section 2.10, Care, Maintenance and Storage** of this manual.

5.5 pH

The sondes employ a field replaceable pH electrode for the determination of hydrogen ion concentration. The probe is a combination electrode consisting of a proton selective glass reservoir filled with buffer at approximately pH 7 and a Ag/AgCl reference electrode that utilizes electrolyte that is gelled. A silver wire coated with AgCl is immersed in the buffer reservoir. Protons (H⁺ ions) on both sides of the glass (media and buffer reservoir) selectively interact with the glass, setting up a potential gradient across the glass membrane. Since the hydrogen ion concentration in the internal buffer solution is invariant, this potential difference, determined relative to the Ag/AgCl reference electrode, is proportional to the pH of the media. The pH system of the 600R utilizes individual glass sensing and reference electrodes, but the operating principle is the same.

Our testing of the 6561 pH, 6565 and 6566 pH/ORP sensors and 600R pH system indicates that they should provide long life, good response time, and accurate readings in most environmental waters, including freshwater of low ionic strength. Thus, no special sensor is required (nor offered) for water of low conductivity.

CALIBRATION AND EFFECT OF TEMPERATURE

The software of the sondes calculates pH from the established linear relationship between pH and the millivolt output as defined by a variation of the Nernst equation:

$$E = E_0 + \frac{2.3RT}{nF} * \text{pH} \quad \text{where } E = \text{millivolts output}$$

E_0 = a constant associated with the reference electrode

T = temperature of measurement in degrees Kelvin

R, n, and F are invariant constants

Thus, in simplified $y = mx + b$ form, it is (mv output) = (slope)x(pH) + (intercept). In order to quantify this simple relationship, the instrument must be calibrated properly using commercially available buffers of known pH values. In this procedure, the millivolt values for two standard buffer solutions are experimentally established and used by the sonde software to calculate the slope and intercept of the plot of millivolts vs. pH. Once this calibration procedure has been carried out, the millivolt output of the probe in any media can readily be converted by the sonde software into a pH value, *as long as the calibration and the reading are carried out at the same temperature*. This last qualifier is almost never met in actual environmental measurements since temperatures can vary several degrees during a deployment simply from a diurnal cycle. Thus, a mechanism must be in place to compensate for temperature or, in other words, to accurately convert the slope and intercept of the plot of pH vs. millivolts established at T_c (temperature of calibration) into a slope and intercept at T_m (temperature of measurement). Fortunately, the Nernst equation provides a basis for this conversion.

According to the Nernst equation as shown above, the slope of the plot of pH vs. millivolts is *directly proportional* to the absolute temperature in degrees Kelvin. Thus, if the slope of the plot is experimentally determined to be 59 mv/pH unit at 298 K (25 C), then the slope of the plot at 313 K (40 C) must be $(313/298) * 59 = 62$ mv/pH unit. At 283 K (10 C), the slope is calculated to be 56 mv/pH unit $((283/298) *$

59). Determination of the slope of pH vs. mv plots at temperatures different from T_c is thus relatively simple. In order to establish the intercept of the new plot, the point where plots of pH vs. mv at different temperatures intersect (the isopotential point) must be known. Using standard pH determination protocol, the sonde software assigns the isopotential point as the mv reading at pH 7 and then calculates the intercept using this assumption. Once the slope and intercept to the plot of pH vs. mv are assigned at the new temperature, the calculation of pH under the new temperature conditions is straightforward, and is automatically carried out by the sonde software.

MEASUREMENT AND CALIBRATION PRECAUTIONS

- 1- When filling the calibration cup prior to performing the calibration procedure, make certain that the level of calibrant buffers is high enough in the calibration/storage cup to cover at least ½ inch of the pH probe and the temperature sensor of the 6560 probe.
- 2 - Rinse the sensors with deionized water between changes of calibration buffer solutions.
- 3 - During pH calibration, allow the sensors time to stabilize with regard to temperature (approximately 60 seconds) before proceeding with the calibration protocol. The pH readings after calibration are only as good as the calibration itself.
- 4 - Clean and store the probe according to the instructions found in **Section 2.10, Care, Maintenance and Storage** of this manual.

5.6 TEMPERATURE

The sondes utilize a thermistor of sintered metallic oxide that changes predictably in resistance with temperature variation. The algorithm for conversion of resistance to temperature is built into the sonde software, and accurate temperature readings in degrees Celsius, Kelvin, or Fahrenheit are provided automatically. No calibration or maintenance of the temperature sensor is required.

5.7 FREE CHLORINE

CHLORINE CHEMISTRY

When chlorine gas (Cl_2) is added to water, a reaction (called disproportionation) occurs to form hypochlorous acid (HOCl) and hydrochloric acid (HCl). The hypochlorous acid is a strong oxidant and the active species in most drinking water disinfection processes rather than gaseous chlorine (Cl_2). One molecule of HOCl has the same oxidizing capacity as a molecule of Cl_2 . Thus, the formula for “free chlorine” is really HOCl rather than Cl_2 . (A portion of the free chlorine will also be in the form of hypochlorite ion OCl^- , with the amount depending on the pH of the sample.) However, convention dictates that free chlorine be reported in units of “mg Cl_2 per liter” even though the active compounds in solution are HOCl and OCl^- . Thus, YSI free chlorine readings are expressed in units of “ Cl_2 mg/L” rather than “HOCl/ OCl^- mg/L” to be consistent with standard reporting convention.

There are two categories of “chlorine” in most treated drinking water – **free chlorine** (HOCl + OCl^-) and **combined chlorine** which is made up of species formed in the reaction of free chlorine with ammonia which is present in the water. **Combined Chlorine** is thus made up of a general class of compounds called chloramines with formulae such as NH_2Cl , $NHCl_2$, and NCl_3 . In water which is treated just with chlorine, there will be a small amount of combined chlorine from the natural ammonia in the water and a large amount of free chlorine; in water which is treated with both free chlorine and ammonia there will be a small

amount of free chlorine and a large amount of combined chlorine. **Total Chlorine** is defined as the **sum of the free and combined chlorine concentrations**. Combined chlorine is usually not measured directly. Instead, the free chlorine is measured by a color-forming chemical test under one set of conditions and the total chlorine is measured colorimetrically under a slightly different set of conditions. Since $\text{Total Chlorine} = \text{Free Chlorine} + \text{Combined Chlorine}$, the Combined Chlorine is calculated as the difference between the Total and Free Chlorine values. **It is important to be aware of the fact that the YSI 6572 free chlorine sensor and its electronics measure only free chlorine – the sensor is unresponsive to combined chlorine (chloramines). This makes the sensor of questionable utility for measuring “chlorine” in distribution systems which use ammonia as part of the treatment process and thus have predominantly combined chlorine in their drinking water.**

FREE CHLORINE SENSOR -- GENERAL

The sondes employ an amperometric sensor to measure free chlorine which is similar in design and theory to the patented YSI Rapid Pulse system for the measurement of dissolved oxygen. It is important to note that, while the Rapid Pulse dissolved oxygen sensor is effectively flow independent, the analogous free chlorine sensor possesses significant flow dependence (20-30 % in stagnant water). This characteristic means that you must use the free chlorine sensor in flowing water utilizing YSI flow cells in order to realize the stated accuracy specification.

The Rapid Pulse free chlorine system utilizes a sensor that is similar to other membrane-covered, steady-state amperometric free chlorine sensors. The system still measures the current associated with the reduction of free chlorine which diffuses through a hydrophilic membrane, and this current is proportional to the free chlorine content in the flowing drinking water being evaluated. The user will note from examination of the 6572 free chlorine probe that the sensor consists of three electrodes (a cathode, anode, and reference electrode) while steady state amperometric free chlorine probes usually have only two electrodes (a cathode and a combined anode-reference electrode). In addition, the geometry of the sensor is novel, consisting of a thin linear platinum cathode placed between two silver rectangles which serve as anode and reference electrodes. These sensor changes are necessary to implement the new Rapid Pulse method for free chlorine measurement as described in the following section.

FREE CHLORINE SENSOR -- METHOD OF OPERATION

Standard amperometric free chlorine sensors are continuously polarized at a voltage sufficiently negative to cause free chlorine (hypochlorous acid + hypochlorite ion) to be reduced at the platinum cathode and silver metal to be oxidized to silver chloride at the anode. The voltage must also be sufficiently positive to prevent the reduction of oxygen during the measurement sequence. The free chlorine diffuses through a hydrophilic polyvinylidene membrane and is reduced at the cathode. The current associated with this process is proportional to the free chlorine concentration outside the membrane. As this electrochemical reaction proceeds, free chlorine is consumed (or depleted) in the medium, resulting in a decrease in measured current (and apparent free chlorine content) if the external solution is not stirred rapidly. This flow dependence is minimized (but not eliminated) by rapidly and reproducibly polarizing (on) and depolarizing (off) the probe electrodes during a measurement sequence. The Rapid Pulse system thus measures the charge or coulombs (current summed over a specific time period) associated with the reduction of free chlorine during a carefully controlled time interval. The coulombs due to charging of the cathode (capacitance), but not to reduction of free chlorine, are subtracted during integration after the cathode has been turned off. The net charge, like the steady state current in a standard system, is proportional to the free chlorine concentration in the medium. Note that, as described above, the flow dependence of the sensor is not completely overcome by this method (as it is in Rapid Pulse dissolved oxygen sensors) because of the different diffusion characteristics of free chlorine through the hydrophilic polyvinylidene membrane versus oxygen through a Teflon membrane.

CALIBRATION AND EFFECT OF TEMPERATURE

To calibrate the free chlorine sensor, you must make an independent measurement of the free chlorine in the flow cell effluent at the time of calibration. This is usually done by collecting an effluent sample, adding a chemical to it (DPD) which will form a red color which is proportional to the free chlorine in the sample and then determining the intensity of the color using a commercial colorimeter. The analysis is very simple and takes only about 2 minutes to perform. Once the true chlorine value has been determined from the DPD colorimetric analysis, this value is input into the sonde software and the calibration is confirmed.

The YSI 9000 and 9100 Photometers and the version of the Hach Pocket Colorimeter™ II which is specific for free and total chlorine are examples of colorimeters which can be purchased for the analysis of free chlorine in water samples. In addition, you usually will need to purchase the color-forming reagents in either pill or powder form – YSI Item # YAP 001 for the YSI photometers; Hach Item # 21055-69 for the Hach colorimeter. The cost of the reagents is nominal.

NOTE CAREFULLY: YSI does not recommend the calibration of the free chlorine using standards prepared from commercial bleach. This procedure is likely to result in significant errors in your subsequent readings for three reasons: (1) The concentration of hypochlorite on the bleach bottle is for new bleach batches and may not be correct if the bleach has been on the shelf for varying periods of time; (2) Dilute solutions of hypochlorite may be unstable and change during the calibration procedure; and (3) Because the free chlorine sensor is flow dependent, it needs to be calibrated in water flowing at the same rate as will be used in the continuous monitoring studies. This flow condition is almost impossible to meet by immersing the sensors in stagnant or agitated solutions of bleach. It is important to understand that YSI may not be able to provide customer support for users who do not perform their free chlorine sensor calibrations by the recommended procedure.

The free chlorine system is calibrated using the same basic methods employed for other sonde sensors. The important thing to remember is to calibrate your sensor versus a flow cell effluent in the mode which you will be using to measure free chlorine. There are four basic modes of operation as described below with their corresponding calibration instructions:

1. **Stand-alone applications where data is being logged only to the internal memory of the sonde at a user selected interval.** For this mode of operation, make certain that the Autosleep RS232 feature is activated in the **Advanced|Setup** menu and that the Chlorine warm-up time is set to 60 seconds in the **Advanced|Sensor** menu. With these software entries in place, the user will input the free chlorine value from the DPD analysis of the flow cell effluent, and the unit will automatically calibrate after the selected warm up time.
2. **Applications where the sonde is attached to a YSI 6500 Process Monitor utilizing the Sample and Hold feature of the sonde software.** For this mode of operation, first activate the **Sample and Hold** feature from the **Setup sonde** menu of the 6500 (Press the **Esc** and **Enter** keys of the 6500 front panel simultaneously to access this menu). Then select the desired interval for data to be sent to the 6500. Exit to the main display mode of the 6500 by pressing the **Esc** key repetitively and then press the **Cal** key on the 6500 front panel. Highlight the free chlorine sensor entry, enter the value from the DPD analysis of the effluent and press **Enter**. Then press **Enter** again to confirm the calibration.
3. **Applications where the sonde is attached to a YSI 6500 Process Monitor and is outputting data continuously to the 6500.** For this mode of operation, access the **Setup sonde** menu of the 6500 as described above and make certain that the Sample and Hold feature is **INACTIVE**. Then exit to the main display mode of the 6500 by pressing the **Esc** key repetitively and press the **Cal** key on the 6500 front panel. Highlight the free chlorine sensor entry, enter the value from the DPD analysis of the effluent and press **Enter**. Observe the free chlorine readings in real-time and, when stable, press the **Enter** key to confirm the calibration. Note that this method of

operation is NOT RECOMMENDED by YSI due to potential sensor maintenance issues as described in detail in Appendix G of this manual.

4. **Applications where the sonde is attached to a PC and data is being displayed to the computer monitor using the Real-Time mode of EcoWatch for Windows.** For this mode of operation, you must calibrate the free chlorine sensor before activating the Real-Time EcoWatch mode of EcoWatch. Access the sonde menu after connection of the sonde to a PC or 650 Display logger and make certain that the Autosleep RS232 feature is activated in the **Advanced|Setup** menu and that the Chlorine warm-up time is set to 60 seconds in the **Advanced|Sensor** menu. With these software entries in place, the user will input the free chlorine value from the DPD analysis of the flow cell effluent, and the unit will automatically calibrate after the selected warm up time. After calibration, select the Run|Discrete Sample entry from the sonde menu and set the Discrete Sample interval to the value corresponding to the frequency at which you wish data to be logged to the hard drive of your PC. Then click on the Real-Time entry in the top EcoWatch toolbar (Do NOT click on the sonde icon in the lower toolbar). The Real-Time study will start automatically with data displayed graphically on the PC monitor and logged to the hard drive of the PC under the file name which you have selected. See Section 4.3.5 of this manual for detailed instruction in using the EcoWatch Real-Time mode.

The free chlorine readings are affected by temperature (approximately 2.5 % per degree Celsius) due to the effect of temperature on the diffusion of free chlorine through the membrane. Note, however, that the sonde software automatically carries out this compensation using the Chlorine tempco factor found in the **Advanced|Sensor** menu. The default value of this factor should NOT be changed except under unusual conditions and only then after contacting YSI Technical Support for advice.

FLOW DEPENDENCE

As noted above, the Rapid Pulse free chlorine sensor exhibits significant flow dependence (20-30 %) in stagnant water. This dependence is overcome by a water flow rate through the flow cell of approximately 500 mL/minute and therefore lower flow rates are not recommended. Note also that this characteristic means that you must use the free chlorine sensor in flowing water utilizing YSI flow cells in order to realize the stated accuracy specification.

EFFECT OF PH

The YSI free chlorine sensor appears to be less sensitive to OCl^- than it is to HOCl and as the pH rises, there is no question that the amount of HOCl relative to OCl^- is reduced significantly. This means that the sensitivity of the sensor to the mixture of HOCl and OCl^- is reduced at high pH, but the sensor has been shown empirically to still have enough overall sensitivity to be functional at pH values up to ca. 9.3 and data to support this claim is available on request from YSI. (Note, however, that at pH values above 8.8, there is a possibility that calibration errors might occur. If you see these errors, contact YSI Technical Support for advice on whether to override them.)

The YSI philosophy relative to the use of the free chlorine sensor at high pH is to calibrate the sensor under these conditions of reduced sensitivity in the high pH water and then assume that minor variations in pH will have only a minimal effect on accuracy during the monitoring study. This philosophy has been adopted rather than compensating for changes in pH using the on-board pH sensor in the sonde. It was decided not to do pH compensation because chlorine is usually the most important parameter to the drinking water industry and the accuracy of this parameter would be grossly compromised if a pH sensor failed while providing compensation data during long term monitoring studies. In other words, we feel that the risk of pH probe failure or significant drift is more likely to be a problem to users than the smaller inaccuracies in the uncompensated pH data which might result from small changes in pH. Note that the

quoted accuracy specification for water which has a pH of greater than 8.5 is only valid if the pH changes less than 0.3 pH units from the pH at the time of calibration. In addition, users should note that it will not be possible to make free chlorine measurements with the YSI free chlorine sensor under any conditions if the pH exceeds ca. 9.3.

5.8 NITRATE

The sonde nitrate probe consists of a silver/silver chloride wire electrode in a custom filling solution. The internal solution is separated from the sample medium by a polymer membrane, which selectively interacts with nitrate ions. When the probe is immersed in water, a potential is established across the membrane that depends on the relative amounts of nitrate in the sample and the internal filling solution. This potential is read relative to the Ag/AgCl reference electrode of the sonde pH probe. As for all ISEs, the linear relationship between the logarithm of the nitrate activity (or concentration in dilute solution) and the observed voltage, as predicted by the Nernst equation, is the basis for the determination.

Under ideal conditions, the Nernst equation predicts a response of 59 mV for every 10-fold rise in nitrate activity at 25°C. However, in practice, empirical calibration of the electrode is necessary to establish the slope of the response. Typical slopes are 53-58 mV per decade for YSI sensors. This slope value is determined by calibration with two solutions of known nitrate concentration (typically 1 mg/L and 100 mg/L NO₃-N). The slope of the plot of log (nitrate) vs. voltage is also a function of temperature, changing from its value at calibration by a factor of the ratio of the absolute temperatures at calibration to that at measurement. The point where this new plot of log (nitrate) vs. voltage intersects the calibration plot is called the isopotential point, that is, the nitrate concentration at which changes in temperature cause no change in voltage. Our experience with ISEs indicates that for best accuracy, the isopotential point should be determined empirically. To do so, the user employs a third calibration point where the voltage of the lower concentration standard is determined at a temperature at least 10°C different from the first two calibration points. The slope, offset, and isopotential point drift slowly, and you should recalibrate the probe periodically.

All ion selective electrodes are subject to the interaction of species with the sensor membrane, which are similar in nature to the analyte. For example, chloride ion binds in this way to the nitrate membrane and produces positive nitrate readings even when no nitrate is present in the medium. Fortunately, most fresh water does not usually contain significant quantities of ions that produce a large interference on the nitrate reading, such as azide, perchlorate, and nitrite. It usually does contain some chloride and carbonate ions, but the interference from these ions is relatively small. For example, if the all of the ionic content of water with a conductivity of 1.2 mS/cm (Sal = 0.6) were due to the presence of sodium chloride, the nitrate reading would be erroneously high by about 1.6 mg/L. If the conductivity in this sample were all due to sodium bicarbonate, the sensor output would indicate the presence of only 0.2 mg/L of non-existent nitrate from the interference.

Even though the interference from chloride is relatively small and thus tolerable at low salinity, the large quantity of this species in salt or brackish water creates interference so great as to make the sensor unsuitable for these media.

Despite the potential problems with interference when using ISEs, it is important to remember that almost all-interfering species produce an artificially high nitrate reading. Thus, if the sonde indicates the presence of only small quantities of nitrate, it is unlikely that the reading is erroneously low because of interference. Unusually high nitrate readings (which could be due to interfering ions) should be confirmed by laboratory analysis after collection of water samples.

Ion selective electrodes have the greatest tendency to exhibit calibration drift over time of all the sensors available on the sonde. This drift should not be a major problem for sampling studies where the instrument can be frequently calibrated. However, if a nitrate sensor is used in a longer-term deployment study with

the sonde, the user should be aware that drift is almost certain to occur. The extent of the drift will vary depending on the age of the probe, the flow rate at the site, and the quality of the water. For all monitoring studies using ion selective electrodes, the user should acquire a few “grab samples” during the course of the deployment for analysis in the laboratory by chemical means or with another nitrate sensor which has been recently calibrated. Remember that the typical accuracy specification for the sensor (+/- 10 % of the reading or 2 mg/L, whichever is larger) refers to sampling applications where only minimal time has elapsed between calibration and field use.

CALIBRATION AND EFFECT OF TEMPERATURE

The nitrate sensor should be calibrated using solutions of known nitrate-nitrogen content according to the procedures detailed in **Sections 2.6.1 and 2.9.2**. If a two point calibration protocol is used, the temperature of the standards should be as close as possible to that of the environmental medium to be monitored. The recommended calibration procedure is one involving three solutions. Two of the solutions should be at ambient temperature while the third should be at least 10 degrees Celsius different from ambient temperature. This protocol minimizes the effects of taking readings at temperatures that are significantly different from ambient laboratory temperatures.

MEASUREMENT AND CALIBRATION PRECAUTIONS

- (1) The temperature response of ion selective electrodes is not as predictable as that of pH sensors. Therefore, be sure to carry out a 3-point calibration the first time you use the probe. This will provide a default setting for the effect of temperature on your particular sensor. After this initial calibration, you can use the less time-consuming 2 point and 1-point routines to update the 3-point calibration. However, we strongly recommend a new 3-point calibration after each deployment of 30 days or longer.
- (2) Ion selective electrodes may not stabilize as rapidly as pH sensors. Be sure to allow plenty of time for the readings to come to their final values during all calibration routines.
- (3) Ion selective electrodes generally drift more than pH sensors. To check for this drift, place the sonde in one of your standards at the end of each deployment.
- (4) Nitrate standards are good growth media for a variety of organisms. This growth can significantly reduce the nitrogen content of your standards, an effect that is particularly important for the 1 mg/L solution. It is best to use new standards for each deployment, but if you decide to save your solutions for reuse, we recommend refrigerated storage to minimize the growth of these organisms.
- (5) Remember that the nitrate sensor will take longer to stabilize after exposure to pH buffers. To accelerate this process, soak the sensor in 100 mg/L standard for a few minutes after performing a pH calibration. In addition, be particularly careful that readings are stable during nitrate calibration after exposure to buffers.

CAUTION: *The nitrate membrane module is for use only at depths less than 50 feet (15.2 meters). Use of the probe at greater depths is likely to permanently damage the sensor.*

5.09 AMMONIUM AND AMMONIA

The sonde ammonium probe employs a silver/silver chloride (Ag/AgCl) wire electrode in a custom filling solution. Nonactin membrane separates the internal solution from the sample medium and this membrane selectively interacts with ammonium ions. When the probe is immersed in water, a potential is established across the membrane that depends on the relative amounts of ammonium in the sample and the internal

filling solution. This potential is read relative to the reference electrode of the sonde pH probe. As for all ISEs, there is a linear relationship between the logarithm of the ammonium activity (or concentration in dilute solution) and the observed voltage. The Nernst equation describes this relationship.

Under ideal conditions, the Nernst equation predicts a response of 59 mV for every 10-fold rise in ammonium activity at 25°C. In practice, however, empirical calibration of the electrode is necessary to establish an accurate slope of the response. Typical empirical slopes are 53-58 mV per decade for YSI sensors. This slope value is determined by calibration with two solutions of known ammonium concentration (typically 1 mg/L and 100 mg/L $\text{NH}_4^+\text{-N}$).

The slope of the plot of log (ammonium) vs. voltage is also a function of temperature. The slope changes by a factor that is the ratio of the absolute temperature of calibration to absolute temperature of measurement. The point where this new plot of log (ammonium) vs. voltage intersects the calibration plot is called the isopotential point, that is, the ammonium concentration at which changes in temperature cause no change in voltage. Our experience with ISEs indicates that for best accuracy, the isopotential point should be determined empirically. To do so, use a third calibration point where the voltage of the lower concentration standard is determined at a temperature at least 10°C different from the first two calibration points. The slope, offset, and isopotential point drift slowly, and the probe should be recalibrated periodically.

All ion selective electrodes are subject to interference from ions, which are similar in nature to the analyte. For example, sodium and potassium ions bind to the ammonium membrane and produce positive readings even when no ammonium is present. Fortunately, fresh water does not usually contain enough interfering ions to produce large errors. For example, a common conductivity for freshwater is about 1.2 mS/cm ($\text{Sal} = 0.6$). Even if the ionic content were due to sodium chloride, the ammonium reading would be erroneously high, about 0.4 mg/L.

However, brackish or seawater has enough sodium and potassium to cause interference so great as to make the sensor unsuitable for these media.

The sensor used in the sonde detects only ammonium ions (NH_4^+), the predominant form of total ammonium nitrogen in most environmental samples. However, using the concurrently determined values of pH, temperature, and conductivity, the sonde software can also provide the user with the concentration of free ammonia (NH_3) in the sample under investigation.

Ammonium ions and free ammonia are in equilibrium in any solution according to the following equation:

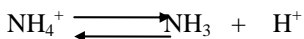

The value of the equilibrium constant associated with this reaction, $K = [\text{NH}_3][\text{H}^+]/[\text{NH}_4^+]$, and its variation with temperature and salinity, is well known. This information allows the free ammonia concentration $[\text{NH}_3]$ to be automatically calculated by the sonde software and displayed if this parameter is activated.

Despite the potential problems with interference when using ISEs, it is important to remember that almost all interfering species produce an artificially high ammonium reading. Thus, if the sonde indicates the presence of only small quantities of ammonium, it is unlikely that the reading is erroneously low because of interference. Unusually high ammonium readings (which could be due to interfering ions) should be confirmed by laboratory analysis after collection of water samples.

Of all the sensors available on the sonde, ion selective electrodes have the greatest tendency to exhibit calibration drift over time. This drift should not be a major problem for sampling studies where the instrument can be frequently calibrated. However, if an ammonium sensor is used in a longer-term deployment study with the sonde, the user should be aware that drift is almost certain to occur. The extent of the drift will vary depending on the age of the probe, the flow rate at the site, and the quality of the water. For all monitoring studies using ion selective electrodes, the user should acquire a few “grab samples” during the course of the deployment for analysis in the laboratory by chemical means or with

another ammonium sensor which has been recently calibrated. Remember that the typical accuracy specification for the sensor (+/- 10 % of the reading or 2 mg/L, whichever is larger) refers to sampling applications where only minimal time has elapsed between calibration and field use.

CALIBRATION AND EFFECT OF TEMPERATURE

The ammonium sensor should be calibrated using solutions of known total ammonium-nitrogen content according to the procedures detailed in **Sections 2.6.1 and 2.9.2**. If a two point calibration protocol is used, the temperature of the standards should be as close as possible to that of the environmental medium to be monitored. The recommended calibration procedure is one involving three solutions. Two of the solutions should be at ambient temperature while the third should be at least 10 degrees Celsius different from ambient temperature. This protocol minimizes the effects of taking readings at temperatures that are significantly different ambient laboratory temperatures.

MEASUREMENT AND CALIBRATION PRECAUTIONS

(1) The temperature response of ion selective electrodes is not as predictable as that of pH sensors. Therefore, be sure to carry out a 3-point calibration the first time you use the probe. This will provide a default setting for the effect of temperature on your particular sensor. After this initial calibration, you can use the less time consuming 2 point and 1-point routines to update the 3-point calibration. However, we strongly recommend a new 3-point calibration after each deployment of 30 days or longer.

(2) Ion selective electrodes may not stabilize as rapidly as pH sensors. Be sure to allow plenty of time for the readings to come to their final values during all calibration routines.

(3) Ion selective electrodes generally drift more than pH sensors. To check for this drift, place the sonde in one of your standards at the end of each deployment.

(4) Ammonium standards are good growth media for a variety of organisms. This growth can significantly reduce the nitrogen content of your standards, an effect that is particularly important for the 1 mg/L solution. It is best to use new standards for each deployment, but if you decide to save your solutions for reuse, we recommend refrigerated storage to minimize the growth of these organisms.

(5) Remember that the ammonium sensor will take longer to stabilize after exposure to buffers in a sonde pH calibration. To accelerate this process, soak the sensor in 100 mg/L standard for a few minutes after performing a pH calibration. In addition, be particularly careful that readings are stable during ammonium calibration after exposure to buffers.

CAUTION: *The ammonium membrane module is for use only at depths less than 50 feet (15.2 meters). Use of the probe at greater depths is likely to permanently damage the sensor.*

5.10 CHLORIDE

The sonde chloride probe employs a solid state membrane attached to a conductive wire. When the probe is immersed in water, a potential is established across the membrane that depends on the amount of chloride in the medium. This potential is read relative to the reference electrode of the sonde pH probe. As for all ISEs, there is a linear relationship between the logarithm of the chloride activity (or concentration in dilute solution) and the observed voltage. The Nernst equation describes this relationship.

Under ideal conditions, the Nernst equation predicts a response of 59 mV for every 10-fold rise in chloride activity at 25°C. However, in practice, empirical calibration of the electrode is necessary to establish the slope of the response. Typical slopes are 45-55 mV per decade for YSI sensors. This slope value is determined by calibration with two solutions of known chloride concentration (typically 10 mg/L and 1000 mg/L Cl).

The slope of the plot of log (chloride) vs. voltage is also a function of temperature, changing from its value at calibration by a factor of the ratio of the absolute temperatures at calibration to that at measurement. The point where this new plot of log (chloride) vs. voltage intersects the calibration plot is called the isopotential point, that is, the chloride concentration at which changes in temperature cause no change in voltage. Our experience with ISEs indicates that for best accuracy, the isopotential point should be determined empirically. To do so, the user employs a third calibration point where the voltage of the lower concentration standard is determined at a temperature at least 10°C different from the first two calibration points. The slope, offset and isopotential point drift slowly, and the probe should be recalibrated periodically.

All ion selective electrodes are subject to the interaction of species with the sensor membrane, which are similar in nature to the analyte. These interfering species thus include other halide ions (fluoride, bromide, and iodide) as well as other anions.

Despite the potential problems with interference when using ISEs, it is important to remember that almost all interfering species produce an artificially high chloride reading. Thus, if the sonde indicates the presence of only small quantities of chloride, it is unlikely that the reading is erroneously low because of interference. Unusually high chloride readings (which could be due to interfering ions) should be confirmed by laboratory analysis after collection of water samples.

Of all the sensors available on the sonde, ion selective electrodes have the greatest tendency to exhibit calibration drift over time. This drift should not be a major problem for sampling studies where the instrument can be frequently calibrated. However, if a chloride sensor is used in a longer-term deployment study with the sonde, the user should be aware that drift is almost certain to occur. The extent of the drift will vary depending on the age of the probe, the flow rate at the site, and the quality of the water. For all monitoring studies using ion selective electrodes, the user should acquire a few “grab samples” during the course of the deployment for analysis in the laboratory by chemical means or with another chloride sensor which has been recently calibrated. Remember that the typical accuracy specification for the sensor (+/- 15 % of the reading or 5 mg/L, whichever is larger) refers to sampling applications where only minimal time has elapsed between calibration and field use.

CALIBRATION AND EFFECT OF TEMPERATURE

The chloride sensor should be calibrated using solutions of known chloride content according to the procedures detailed in **Sections 2.6.1 and 2.9.2**. If a two point calibration protocol is used, the temperature of the standards should be as close as possible to that of the environmental medium to be monitored. The recommended calibration procedure is one involving three solutions. Two of the solutions should be at ambient temperature while the third should be at least 10 degrees Celsius different from ambient temperature. This protocol minimizes the effects of taking readings at temperatures that are significantly different ambient laboratory temperatures.

MEASUREMENT AND CALIBRATION PRECAUTIONS

(1) The temperature response of ion selective electrodes is not as predictable as that of pH sensors. Therefore, be sure to carry out a 3-point calibration the first time you use the probe. This will provide a default setting for the effect of temperature on your particular sensor. After this initial calibration, you can use the less time-consuming 2 point and 1-point routines to update the 3-point calibration. However, we strongly recommend a new 3-point calibration after each deployment of 30 days or longer.

(2) Ion selective electrodes may not stabilize as rapidly as pH sensors. Be sure to allow plenty of time for the readings to come to their final values during all calibration routines.

(3) Ion selective electrodes generally drift more than pH sensors. Be sure to check for this drift by placing the sonde in a standard at the end of each deployment.

(4) Remember that the chloride sensor will take longer to stabilize after exposure to pH buffers. To accelerate this process, soak the sensor in 1000 mg/L standard for a few minutes after performing a pH calibration. In addition, be particularly careful that readings are stable during chloride calibration after exposure to buffers.

5.11 TURBIDITY

Turbidity is the measurement of the content of suspended solids (cloudiness) in water and is typically determined by shining a light beam into the sample solution and then measuring the light that is scattered off of the particles which are present. For turbidity systems capable of field deployment, the usual light source is a light emitting diode (LED) which produces radiation in the near infrared region of the spectrum. The detector is usually a photodiode of high sensitivity. The angle between the emitted and detected light varies (usually between 90 and 180 degrees) depending on the probe used. The International Standards Organization (ISO) recommends the use of a light source with a wavelength between 830 and 890 nm and an angle of 90 degrees between the emitted and detected radiation (ISO 7027).

The turbidity system available as an option for use with the YSI sondes consists of a probe which conforms to the above ISO recommendations. The output of the sonde turbidity sensor is processed via the sonde software to provide readings in nephelometric turbidity units (NTUs).

The 6136 turbidity probe is available for use with YSI sondes. The probe is equipped with a mechanical wiper to periodically clean the sensor either by manual or automatic activation. These wiper systems make the probe ideal for long term monitoring.

While drinking water is very clean relative to surface water, it is important to remember that optical measurements drinking water can still be susceptible to fouling, not only from long term build up of impurities or those flushed from older distribution pipes, but also to shorter term formation of bubbles from outgassing of the water. These bubbles can generally be removed in short term sampling application by simply agitating the sonde manually. However, for studies longer than a few hours where the user is not present at the site, the quality of the turbidity data obtained with a turbidity sensor that has no capability of mechanical cleaning is likely to be poor. However, as noted above, both the 6136 probe is equipped with a mechanical wiper that makes them ideal for unattended applications. The wiper can be activated in real-time during discrete sampling operations or will function automatically during long term unattended sampling studies. The number of wiper movements and the frequency of the cleaning cycle for the unattended mode can be set in the sonde software. Generally one movement is sufficient for most environmental applications, but in media with particularly heavy fouling, additional cleaning cycles may be necessary.

CALIBRATION AND EFFECT OF TEMPERATURE

The sonde software offers the option of 1-point, 2-point, or 3-point calibrations procedures. For most applications, a 2-point calibration at 0 and approximately 100 NTU is sufficient for the 6136 sensor to meet the quoted accuracy specification of +/- 2% of the reading or 0.3 NTU, whichever is greater. (Note that the specification is relative to measurements in calibration standards.) However, a user might wish to carry out a 3-point calibration at values of approximately 0, 100 and 1000 NTU to provide maximum accuracy over the entire normally encountered environmental turbidity range (0-1000 NTU). If the range of turbidity in the environmental sample is well known, standards of other turbidity values can be utilized (in either 3 point or 2 point routines). However, in all calibration procedures, one of the standards must be 0 NTU and this should be the first calibration point.

NOTE: Before calibrating your 6136 turbidity sensor, pay particular attention to the following caution:

- For all calibration procedures, you **MUST** use standards that are based on either formazin or AMCO-AEPA styrene divinylbenzene beads as described in *Standard Methods for the Examination of Water and Wastewater* and have been prepared either by Hach (formazin based) or AMCO-AEPA based standards prepared by YSI or an approved YSI vendor listed on the YSI website (www.yisi.com). **THE USE OF STANDARDS FROM OTHER VENDORS AND/OR THOSE PREPARED FROM MATERIALS OTHER THAN FORMAZIN OR AMCO-AEPA POLYMER BEADS WILL RESULT IN BOTH CALIBRATION ERRORS AND INACCURATE FIELD READINGS.**

YSI and its approved vendors offer easy-to use AMCO-AEPA turbidity standards which can also be quantitatively diluted with turbidity-free water to provide calibrant suspensions of lower values. Hach also offers relatively inexpensive formazin suspensions at various NTU values up to 1000 NTU under the Stabcal™ designation which will provide accurate calibration of either the 6026 or 6136 sensors as long as the user is willing to exercise the proper safety precautions as outlined in the MSDS associated with formazin. The primary advantage of the Hach formazin standards is their cost; their primary disadvantage is that the suspended matter settles out fairly rapidly. Although the AMCO-AEPA standards are somewhat more expensive, they do not settle out, making them significantly easier to use.

While the effect of temperature on the turbidity sensor is small, this factor is automatically taken into account by the sonde software providing temperature compensated readings. Temperature coefficients of 0.3%/degree C and 0.6%/degree C are automatically activated for the 6026 and 6136, respectively, when these sensors are activated in the **Sensor** menu.

MEASUREMENT AND CALIBRATION PRECAUTIONS

(1) For best results, use only freshly prepared or purchased turbidity standards. Degradation of standards can occur on standing, particularly formazin prepared from dilution of concentrated suspensions such as Hach 4000 NTU standard.

(2) If unusually high or jumpy readings are observed during the calibration protocol, it is likely that there are bubbles on the optics. Manually activating the wiper of the 6026 or 6136 from a computer or 650 MDS keypad removes these bubbles.

(3) When calibrating the 6136 sensor, be aware of the fact that precautions must be taken to avoid interference of the bottom of the calibration vessel. Instructions for two methods of calibrating the 6136 sensor are provided in Section 2.6.1 of this manual. The best solution to the interference problem, however, is to purchase the 655488 Extended Calibration Cup Sleeve which completely eliminates the issue.

The sonde turbidity system allows the user to either observe these real turbidity events (while obtaining somewhat jumpy readings) or to apply a mathematical filter to the raw data so that the NTU output may be more reflective of the overall cloudiness of the environmental sample. From the **Advanced|Data Filter** menu of the sonde software, the user can activate the data filter that is specific to turbidity and “fine tune” its performance. For typical sampling and monitoring applications, YSI recommends that the Data Filter settings be selected as follows: Enabled -- On; Wait for Filter -- Off; Time Constant = 12; Threshold = 0.010.

For most unattended sampling applications, selection of the above filter settings should also be appropriate. However, an additional capability is also available which enhances the elimination of spurious single point spikes from the logged data and thus allows for a better presentation of the average turbidity during the deployment. This “**Turb Spike Filter**” is activated/deactivated in the **Advanced|Sensor** menu. Its capability is further described in **Section 2.9.8, Advanced**. YSI recommends the use of this feature for all

unattended studies. The user should determine from experience whether its activation is also appropriate for spot sampling studies at particular sites.

5.12 CHLOROPHYLL

INTRODUCTION

Chlorophyll, in various forms, is bound within the living cells of algae, phytoplankton, and other plant matter found in environmental water. Chlorophyll is a key biochemical component in the molecular apparatus that is responsible for photosynthesis, the critical process in which the energy from sunlight is used to produce life-sustaining oxygen. In general, the amount of chlorophyll in a collected water sample is used as a measure of the concentration of suspended phytoplankton, the magnitude of which can significantly affect the overall quality of the water.

The use of the measurement of phytoplankton as an indicator of water quality is described in Section 10200 A. of *Standard Methods for the Examination of Water and Wastewater*. The classical method of determining the quantity of chlorophyll at a particular site is to collect a fairly large water sample and analyze it in the laboratory. The procedure involves filtration of the sample to concentrate the chlorophyll containing organisms, mechanical rupturing of the collected cells, and extraction of the chlorophyll from the disrupted cells into the organic solvent, acetone. The extract is then analyzed by either a spectrophotometric method using the known optical properties of chlorophyll or by high performance liquid chromatography (HPLC). This general method is detailed in Section 10200 H. of *Standard Method* and has been shown to be accurate in multiple tests and applications as long as a competent laboratory analyst carries out the protocol. The procedure is generally accepted for reporting in scientific literature. The method is time-consuming, however, and usually requires an experienced, efficient analyst to generate consistently accurate and reproducible results. It also does not lend itself readily to continuous monitoring of chlorophyll, and thus phytoplankton, since the collection of samples at reasonable time intervals, e.g., every hour, would be extremely tedious.

YSI has developed the YSI 6025 chlorophyll sensor for the determination of chlorophyll in spot sampling and continuous monitoring applications. It is based on an alternative method for the measurement of chlorophyll which overcomes these disadvantages, albeit with the potential loss of accuracy. In this procedure, chlorophyll is determined *in vivo*, i.e., without disrupting the cells as in the extractive analysis. The YSI 6025 chlorophyll sensor is designed for these *in vivo* applications and its use allows the facile collection of large quantities of chlorophyll data in either spot sampling or continuous monitoring applications. It is important to remember, however, that the results of *in vivo* analysis will not be as accurate as those from the certified extractive analysis procedure.

The limitations of the *in vivo* method are outlined below and should be carefully considered before making chlorophyll determinations with your YSI sonde and sensor. Some of the sources of inaccuracy can be minimized by combining the data from the YSI 6025 with data from extractive analysis of a few samples acquired during a sampling or monitoring study. However, the *in vivo* studies will never replace the standard procedure. Rather, the estimates of chlorophyll concentration from the easy-to-use YSI chlorophyll system are designed to complement the more accurate (but more difficult to obtain) results from more traditional methods of chlorophyll determination.

MEASUREMENT OF CHLOROPHYLL *IN VIVO*

One key characteristic of chlorophyll is that it fluoresces, that is, when irradiated with light of a particular wavelength, it emits light of a higher wavelength (or lower energy). The ability of chlorophyll to fluoresce

is the basis for all commercial fluorometers capable of measuring the analyte *in vivo*. Fluorometers of this type have been in use for some time. These instruments induce chlorophyll to fluoresce by shining a beam of light of the proper wavelength into the sample, and then measuring the higher wavelength light which is emitted as a result of the fluorescence process. Most chlorophyll systems use a light emitting diode (LED) as the source of the irradiating light that has a peak wavelength of approximately 470 nm. LEDs with this specification produce radiation in the visible region of the spectrum with the light appearing blue to the eye. On irradiation with this blue light, chlorophyll resident in whole cells emits light in the 650-700 nm region of the spectrum. To quantify the fluorescence the system detector is usually a photodiode of high sensitivity that is screened by an optical filter that restricts the detected light. The filter prevents the 470 nm exciting light from being detected when it is backscattered off of particles in the water. Without the filter, turbid (cloudy) water would appear to contain fluorescent phytoplankton, even though none were present. The following diagram can be used to better understand the principles of the YSI system.

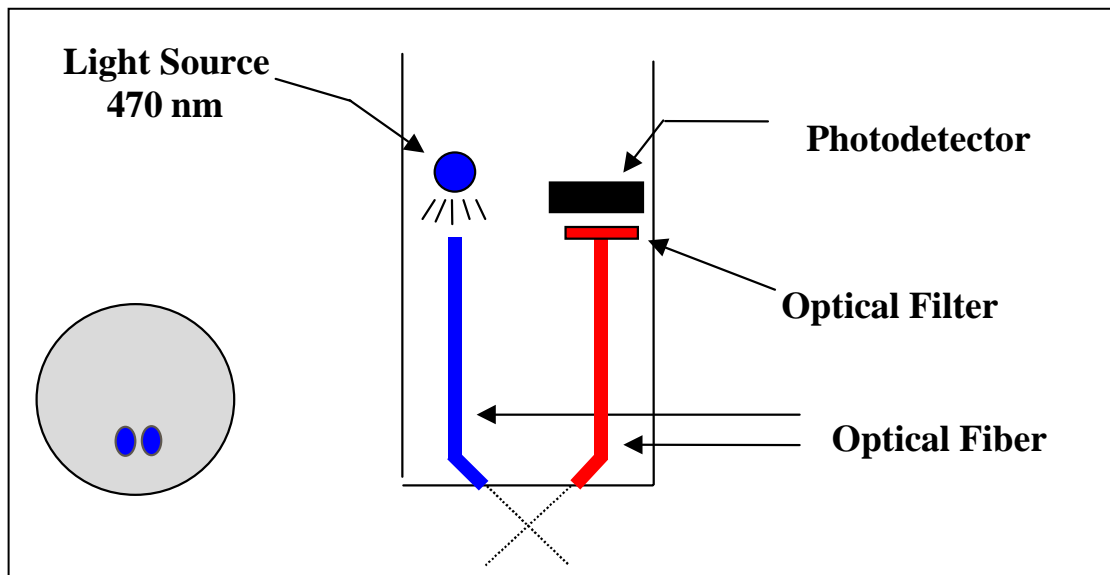

Most commercial fluorometers fit into two categories. In the first category are benchtop instruments that generally have superior optical flexibility and capability but are relatively expensive and are often difficult to use in the field. In the second category are sonde-type fluorometers that have a fixed optical configuration, but are less expensive, can be more easily used in the field, and are usually compatible with data collection platforms. The use of a pump is recommended for some sonde fluorometers and this can result in the need for large capacity batteries for field use.

The unique YSI chlorophyll system available as an option for use with YSI sondes consists of a probe which is similar in concept to the sonde-type fluorometers, but is much smaller, making it compatible with the probe ports of the YSI 6920DW sonde. The output of the sensor is automatically processed via the sonde software to provide readings in either generic fluorescence units (percent full scale; % FS) or $\mu\text{g/L}$ of chlorophyll. No pump is required for the YSI system allowing the sensor to operate off of either the sonde internal batteries or the batteries in the YSI 650 MDS display/logger. Like the YSI 6026 and 6136 turbidity probes, the YSI 6025 chlorophyll probe is equipped with a mechanical wiper to periodically clean the optical face either by manual or automatic activation. With these features, the YSI chlorophyll sensor provides the same level of performance as the sonde fluorometers, but is much easier to use and can be deployed in environmental water for several weeks without the need for service. In addition, the probe will be a component in sondes that can acquire up to ten other parameters simultaneously with chlorophyll, rather just providing the single parameter.

CALIBRATION METHODS -- GENERAL

As described in **Section 2** of this manual, the sonde software offers the option of either zeroing the generic fluorescence parameter (% FS) or of performing 1-point, 2-point, or 3-point calibration procedures in $\mu\text{g/L}$ of chlorophyll. For most applications, a 2-point calibration at 0 and middle range (e.g., ca. $100 \mu\text{g/L}$) is sufficient. Slight non-linearities of the system can be overcome with a 3-point calibration across the normally encountered environmental chlorophyll range (0-400 $\mu\text{g/L}$). If the range of chlorophyll content in the environmental sample is well known, standards of any chlorophyll values can be utilized in either 3-point or 2-point routines. However, one of the standards must be $0 \mu\text{g/L}$ and this standard must be first in the calibration sequence.

For calibration of the YSI chlorophyll system, **only one type of standard will assure accurate field readings: a suspension of phytoplankton of known chlorophyll content**. The chlorophyll content of this suspension should be determined by the extractive analysis procedure described in *Standard Methods*. Most users will not have this analyzed plankton suspension available prior to field studies for use in the 2-point calibration protocol resident in the sonde software. Thus, the best “calibration” method usually comprises the following steps:

1. Prior to use in the field, place the sensor in clean water and perform a 1-point calibration at $0 \mu\text{g/L}$.
2. Immerse the sonde in a dye standard (see below) and record the reading. Note that you are not “calibrating” to the dye reading, only checking its value relative to the default sensitivity of the sensor.
3. While making your field readings (sampling or unattended studies), collect a few grab samples and record the date/time and location where they were acquired.
4. On return to the laboratory, perform extractive analyses for chlorophyll on the grab samples and record the results for later use.
5. After the study is complete, place your YSI chlorophyll data in the column of a spreadsheet and place your laboratory data in an adjacent column for comparison. Calculate ratios of field to laboratory results for each grab sample point and then average the results to produce a ratio for adjustment (or “postcalibration”) of your field results into accurate chlorophyll readings (relative to extractive analysis).
6. Use the calculating power of the spreadsheet to multiply all of your field readings by the correction ratio to obtain the best possible accuracy for your 6025 data.

A variation of this method is to perform a 2-point calibration prior to deployment using a clear water and a dye standard, setting apparent chlorophyll equivalent of the dye standard to the value shown in the tables below. However, it must be emphasized that this technique does not increase the accuracy of the chlorophyll sensor significantly over the simple 1-point calibration recommended above – the user still must collect grab sample and perform laboratory analysis to be assured of meaningful chlorophyll values. The primary utility of the dye is to check for sensor drift during deployment by reanalyzing the dye solution after sonde recovery. The use of the 2-point dye calibration procedure may make it easier to quantify the predeployment dye value and, if so, may be preferable. Remember, however, that no real enhancement of sensor accuracy is attained by using the dye as a calibrant.

PREPARATION OF RHODAMINE WT SOLUTIONS FOR CHECKING SENSOR DRIFT

RHODAMINE WT STANDARD SOLUTION

CAUTION: Be certain to read and follow all the safety instructions and MSDS documentation which is supplied with the dye before proceeding. Remember that only trained personnel should handle chemicals.

Use the following procedure to prepare a Rhodamine WT solution for use as a sensor stability check reagent.

1. Rhodamine WT dye is usually purchased in solution form and can vary somewhat in nominal concentration. YSI uses Rhodamine WT from the supplier noted below and recommends that the user purchase this exact item if possible. The solution is approximately 2 % in Rhodamine WT.

Fluorescent FWT Red Dye (Lot# 257201; 16 Fl. Oz.)

**Kingscote Chemicals
9676 N. Looney Road
Piqua, OH 45356
1-800-394-0678
Fax: 937-773-7994**

2. Accurately transfer 5.0 mL of the Rhodamine WT solution into a 1000 mL volumetric flask. Fill the flask to the volumetric mark with deionized or distilled water and mix well to produce a solution that is approximately 100 mg/L of Rhodamine WT. Transfer this standard to a glass bottle and retain it for future use.
3. Accurately transfer 5.0 mL of the solution prepared in the above step to a 1000 mL volumetric flask and then fill the flask to the volumetric mark with deionized or distilled water. Mix well to obtain a solution, which is 0.5 mg/L in water (a 200:1 dilution of the concentrated solution).
4. Store the concentrated standard solution produced in (6) above in a glass bottle in a refrigerator to retard decomposition. The dilute standard prepared in the previous step should be used within 24 hours of its preparation.

When rhodamine standards are required in the future, perform another dilution of the concentrated rhodamine solution after warming it to ambient temperature. Our experience has indicated that the concentrated solution that has been kept at cold temperatures is much more stable than the dilute solution stored at room temperature.

It is well known that the intensity of the fluorescence of many dyes shows an inverse relationship with temperature. The effect must also be accounted for when “calibrating” the YSI chlorophyll sensor with rhodamine WT. Enter the calibration value from the table below corresponding to the temperature of the standard.

WARNING: The “Chl Tempco” factor in the Advanced|Sensor menu, MUST BE SET TO ZERO, when calibrating with Rhodamine WT.

Table. Approximate algal chlorophyll equivalent of 0.5 mg/L Rhodamine WT as a function of temperature.

T, C	ug/L Chl to Enter	T, C	Ug/L Chl to Enter
30	100	18	122
28	103	16	126
26	106	14	131
24	110	12	136
22	113	10	140
20	118	8	144

REMEMBER: The use of rhodamine WT for “calibration is only an approximation. To assure accurate readings from the 6025 sensor, the user must relate the field fluorescence readings to data from extractive analysis samples as described above. YSI does not provide an accuracy specification for chlorophyll due to these limitations.

EFFECT OF TEMPERATURE ON READINGS

While the effect of temperature on the chlorophyll sensor itself is very small, YSI experiments have indicated that the fluorescence of phytoplankton suspensions can show significant temperature dependence. For example, the apparent chlorophyll content of our laboratory test samples of algae increased from 185 to 226 µg/L when the temperature was dropped from 21 °C to 1 °C even though no change in phytoplankton content took place. In the absence of compensation, this effect would obviously result in errors in field chlorophyll readings if the site temperature were significantly different from the calibration temperature. This temperature error can be reduced by employing a chlorophyll temperature compensation routine (“Chl tempco”) resident in the sonde software under the Advanced|Sensor menu.

From our studies, it appears that entry of a value of 1 to 2 % per degree C for “Chl tempco” is appropriate to partially account for changes in the fluorescence of environmental phytoplankton with temperature. This value can be estimated in the above example as follows:

Change in Temperature = 21–1 = 20 °C
Change in Fluorescence = 226–185 = 41 µg/L
% Change in Fluorescence = (41/185) x 100 = 22.1
Chl Tempco Factor = 22.1/20 = 1.11 % per degree °C

Note that the use of this empirically derived compensation does not guarantee accurate field readings since each species of phytoplankton is likely to be unique with regard to the temperature dependence of its fluorescence. Changes in fluorescence with temperature are a key limitation of the *in vivo* fluorometric method (see below) which can only be reduced, not eliminated, by this compensation. In general, the best way to minimize errors is to calibrate with phytoplankton standards of known chlorophyll content that are as close as possible in temperature to that of the environmental water under investigation.

EFFECT OF FOULING ON OPTICAL MEASUREMENTS

Field optical measurements are particularly susceptible to fouling, not only from long term build up of biological and chemical debris, but also to shorter term formation of bubbles from outgassing of the environmental water. These bubbles can sometimes be removed in short term sampling applications by simply agitating the sonde manually. For studies longer than a few hours where the user is not present at the site, the quality of the chlorophyll data obtained with a fluorescence sensor that has no capability of mechanical cleaning is likely to be compromised. The YSI 6025 probe is equipped with a mechanical wiper that makes it ideal for unattended applications. The wiper can be activated in real-time during discrete sampling operations or will function automatically just before each sample is taken during long term unattended monitoring studies. The number of wiper movements and the frequency of the cleaning cycle for the unattended mode can be set in the sonde software. Generally, one wiper movement is sufficient for most environmental applications, but in media with particularly heavy fouling, additional cleaning cycles may be necessary.

EFFECT OF TURBIDITY ON CHLOROPHYLL READINGS

As described above, the filters in front of the photodiode in the YSI 6025 chlorophyll probe prevent most of the 470 nm light which is used to excite the chlorophyll molecules from reaching the detector after being backscattered off of non-fluorescent particles (turbidity) in environmental water. However, the filter system

is not perfect and a minor interference on chlorophyll readings from suspended solids may result. Laboratory experiments indicate that a suspension of typical soil measured with a YSI 6026 sensor will have a turbidity interference characterized by a factor of about 0.03 $\mu\text{g/L}$ per NTU. For example, the turbidity of the water must be above 100 NTU to produce an apparent chlorophyll reading equal to 3 $\mu\text{g/L}$. In very cloudy water, the user may wish to use the independently-determined turbidity value and the above compensation factor to correct measured chlorophyll values using, for example, a spreadsheet.

LIMITATIONS OF *IN VIVO* CHLOROPHYLL MEASUREMENTS

As noted above, the measurement of chlorophyll from *in vivo* fluorescence measurements will always be less reliable than determinations made on molecular chlorophyll that has been extracted from the cells using the procedures described in *Standard Methods*. This section describes some of the known problems with *in vivo* chlorophyll measurement.

INTERFERENCES FROM OTHER FLUORESCENT SPECIES: The analytical methods described in *Standard Methods* for chlorophyll involve disruption of the living organisms present in suspension, followed by extraction of molecular chlorophyll into a homogeneous solution in an organic solvent. Acidification of the extract helps to minimize the interferences caused by a number of other, non-chlorophyll species. In addition, readings can be taken at various wavelengths on a spectrophotometer to differentiate between the various forms of chlorophyll (a, b, c) and pheophytin a.

In contrast to this fairly controlled situation, all *in vivo* sensors operate under whole-cell, heterogeneous conditions where the sensor will measure, at least to some degree, everything which fluoresces in the region of the spectrum above 630 nm when irradiated with 470 nm light. Therefore, the sensor is really quantifying overall fluorescence under these optical conditions, rather than chlorophyll specifically. While it is probable that most of the fluorescence is due to suspended plant and algal matter and that much of the fluorescence from this biomass is due to chlorophyll, it is impossible to exclude interferences from other fluorescent species using the approach described above.

Note that *in vivo* fluorometers usually cannot differentiate between the different forms of chlorophyll.

LACK OF CALIBRATION REAGENTS: The usual reagents which are used for the calibration of fluorometric measurements for chlorophyll after extraction into organic solvents are purchased as “purified chlorophyll a” from chemical supply vendors such as Sigma. These standards are not soluble in aqueous media and, even if they were, their fluorescence is unlikely to be the same as when the chlorophyll is present in the whole living cell. Therefore, for even a semiquantitative calibration, the user needs a “substitute” standard such as Acridine Orange (see above) to provide a method for estimating the sensitivity of the sensor. Field readings based on this type of calibration will provide only an estimate of chlorophyll in environmental water where the measurement is taken on whole cell suspensions *in vivo*. The calibration standard that provides the best measure of accuracy for *in vivo* chlorophyll sensors is a portion of a phytoplankton suspension that has been analyzed for chlorophyll by the extractive procedure. We recommend the use of this procedure and further recommend that the phytoplankton suspension be taken from the site being monitored so that the species producing the fluorescence in the standard are as close as possible to the field organisms. To truly assess data reliability in a long term monitoring study, grab samples should be taken periodically, e.g. weekly, and analyzed in the laboratory as the study progresses. These data can then be used to “postcalibrate” the readings logged to the instrument during the study, perhaps using a spreadsheet for the simple mathematical treatment. In any case, getting quantitative chlorophyll data from any *in vivo* fluorometric sensor is much more difficult than with most other environmental sensors. For this reason, it is difficult to provide an accuracy specification for chlorophyll measurement made with *in vivo* fluorometers and therefore no accuracy specification is quoted for the YSI 6025.

EFFECT OF CELL STRUCTURE, PARTICLE SIZE, AND ORGANISM TYPE ON *IN VIVO*

READINGS: Even if the only fluorescent species present for *in vivo* measurements were chlorophyll, and reliable calibration standards were available, its absolute quantification would probably still be difficult because samples are not homogeneous. Differing species of algae with differing shape and size will likely fluoresce differently even if the type and concentration of chlorophyll are identical and this significantly limits the accuracy of *in vivo* measurements.

EFFECT OF TEMPERATURE ON PHYTOPLANKTON FLUORESCENCE: As noted above, YSI experiments indicate that phytoplankton fluorescence increases as temperature decreases. Thus, readings taken on a phytoplankton suspension at cold temperature would erroneously indicate the presence of more phytoplankton than when the suspension is read at room temperature. Unless this effect is taken into account, most field readings will be somewhat in error, since the field temperature will differ from the temperature of calibration. The use of the “Chl Tempco” factor found in the Advanced|Sensor menu will help to reduce this error, but must be used with caution since each species of phytoplankton is likely to have a slightly different temperature dependence.

EFFECT OF LIGHT ON PHYTOPLANKTON FLUORESCENCE: It is well documented in the literature that the fluorescence of chlorophyll resident in phytoplankton can be inhibited by light. This “photoinhibition” is confirmed by empirical data that indicate that, at constant phytoplankton level, the fluorescent signal can change significantly on a diurnal schedule, showing less fluorescence during the day and more fluorescence at night. It is clear that this effect would produce errors in the absolute values of chlorophyll unless it were accounted for by the user.

The chlorophyll section of Standard Methods substantiates these limitations along with application notes that are offered by current fluorometer manufacturers. The limitations result in the realization that any *in vivo* “chlorophyll” sensor will be much less quantitative than any of the other sensors offered for use with our sondes.

MEASUREMENT AND CALIBRATION TIPS

1. For best results, analyze field samples to be used for “calibration” of the sensor as soon as possible after collection.
2. If unusually high or jumpy readings are observed during calibration, it is likely that there are bubbles on the optics. The surface should be cleaned by manually activating the wiper before confirming the calibration.
3. The output of the YSI fluorescence sensor is susceptible not only to the overall phytoplankton concentration in the environmental medium, but also to the size and rate of movement of the suspended particles that pass across the optics on the probe face. Thus, although the phytoplankton content of an environmental sample may appear to the eye to be relatively stable, the displayed chlorophyll reading can vary significantly depending on the nature of the particles in the optical path at the instant of measurement. In a discrete sample study of environmental water, for example, the variability of the output can be significant. This apparent jumpiness is not observed in dye standards, since these are homogeneous solutions containing no suspended matter.
4. The sonde chlorophyll system allows the user to apply a mathematical filter to the raw data so that the sensor output may be more representative of the average phytoplankton content of the environmental sample. From the 8-Advanced menu of the sonde software, the user can activate the data filter and adjust its performance. For typical sampling and monitoring applications, YSI recommends that the Data Filter settings for chlorophyll be selected as follows: Enabled -- On; Wait for Filter -- Off; Chlorophyll Time Constant = 12; Chlorophyll Threshold = 1. The advantage of the filter is a more stable display of chlorophyll readings.

5.14 RHODAMINE WT

INTRODUCTION AND PRINCIPLE OF OPERATION

Rhodamine WT is a red dye that is commonly used in stream flow studies. The amount of the species at various points (horizontal and vertical) in the water under examination is determined by utilizing the fact that rhodamine WT fluoresces when irradiated with the proper wavelength of light and thus the YSI 6130 rhodamine WT sensor works on the same principles as described above for the 6025 chlorophyll sensor.

As for chlorophyll, rhodamine WT fluoresces, that is, when irradiated with light of a particular wavelength, it emits light of a higher wavelength (or lower energy). The ability of rhodamine WT to fluoresce is the basis for all commercial fluorometers capable of measuring the analyte *in situ*. Fluorometers of this type have been in use for some time. These instruments induce rhodamine WT to fluoresce by shining a beam of light of the proper wavelength into the sample, and then measuring the higher wavelength light which is emitted as a result of the fluorescence process. Most rhodamine systems use a light emitting diode (LED) as the source of the irradiating light that has a peak wavelength of approximately 540 nm. LEDs with this specification produce radiation in the visible region of the spectrum with the light appearing green to the eye. On irradiation with this green light, rhodamine WT in the water emits visible light with a higher wavelength than that of the exciting beam, i.e. the rhodamine fluoresces. To quantify this fluorescence, the system detector is usually a photodiode of high sensitivity that is screened by an optical filter that restricts the detected light. The filter minimizes (a) the exciting light being detected when it is backscattered off of particles in the water and (b) the interference from other fluorescent species such as the chlorophyll in phytoplankton. Without the filter, turbid (cloudy) water or water with high levels of phytoplankton would appear to contain rhodamine WT, even though none were present. The following diagram can be used to better understand the principles of the YSI rhodamine WT system.

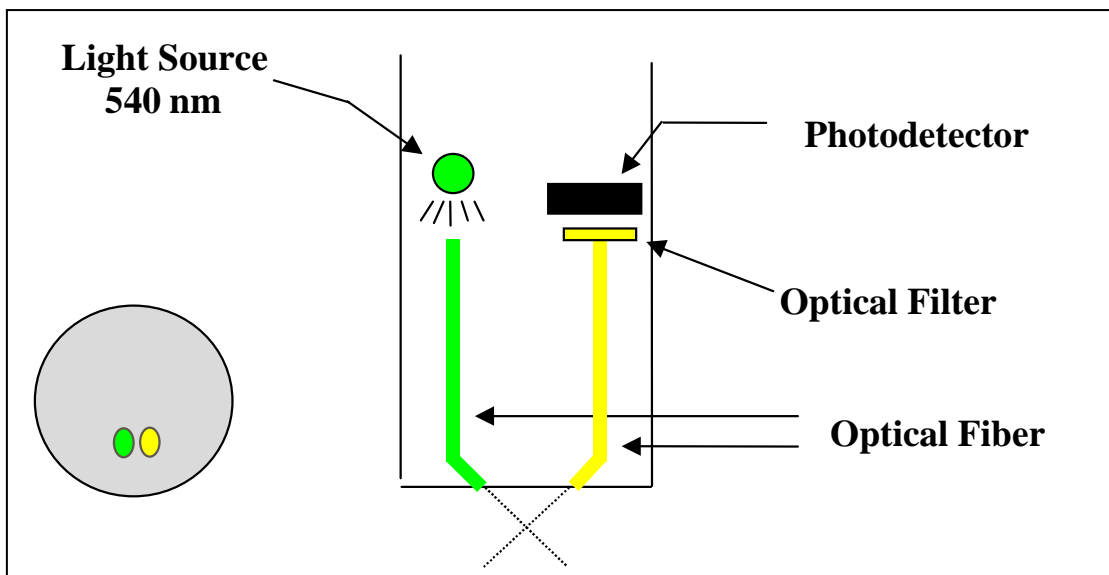

Field optical measurements are particularly susceptible to fouling, not only from long term build up of biological and chemical debris, but also to shorter term formation of bubbles from outgassing of the environmental water. These bubbles can generally be removed in short term sampling application by simply agitating the sonde manually. However, for studies longer than a few hours where the user is not

present at the site, the quality of the data obtained with a rhodamine WT sensor that has no capability of mechanical cleaning may be compromised. Like the 6026 /6136 turbidity and 6025 chlorophyll probes described above, the 6130 rhodamine WT probe is equipped with a mechanical wiper that makes it ideal for unattended applications. The wiper can be activated in real-time during discrete sampling operations or will function automatically during long term unattended sampling studies. The number of wiper movements and the frequency of the cleaning cycle for the unattended mode can be set in the sonde software. Generally one movement is sufficient for most environmental application, but in media with particularly heavy fouling, additional cleaning cycles may be necessary.

CALIBRATION AND EFFECT OF TEMPERATURE

The sonde software offers the option of 1 point, 2 point, or 3 point calibrations procedures. For most applications, a 2-point calibration at 0 and 100 ug/L is sufficient. However, for maximum accuracy over the entire 0-200 ug/L range of the sensor, a 3-point calibration procedure can slightly enhance the accuracy of the sensor. Note that YSI does not offer rhodamine WT standards, but does suggest a vendor for user-production of standards and, later in this section, provides instructions for preparing a solution which is 100 ug/L in Rhodamine WT.

While the effect of temperature on the rhodamine sensor and electronics is small, the fluorescence of rhodamine WT changes significantly with temperature. The combination of the two factors is automatically taken into account by the sonde software providing temperature compensated readings.

RHODAMINE WT STANDARD SOLUTION – PREPARATION AND USE

CAUTION: Before using concentrated rhodamine WT solution to prepare standards, be certain to read the safety instructions provided by the supplier with this chemical. Remember that only trained personnel should handle chemicals.

PREPARATION

Use the following procedure to prepare a 100 ug/L solution that can be used to calibrate your rhodamine WT sensor for field use:

1. We recommend that rhodamine WT concentrate be purchased from Keystone Aniline Corporation, 2501 W. Fulton Street, Chicago, IL 60612 (Telephone: 312-666-2015) under the name KEYACID RHODAMINE WT LIQUID (Part # 70301027). As purchased, the solution is approximately 20 % rhodamine WT by weight, i.e., 200 g/L.
2. Accurately weigh 0.500 g of the 20 % rhodamine concentrate, quantitatively transfer the viscous liquid to a 1000-mL volumetric flask and fill the flask to the top graduation. This solution contains 100 mg of rhodamine WT per 1000 mL of water.
3. Accurately transfer 1.0 mL of the solution prepared in the above step to a 1000 mL volumetric and then fill the flask to the top graduation with purified water. Mix well to obtain a solution that is 100 ug/L (0.10 mg/L) in water (a 1000:1 dilution of the concentrated solution).

4. Store the concentrated standard solution in a darkened glass bottle in a refrigerator to retard decomposition. The dilute standard prepared in the previous step should be used within 5 days of its preparation.

When rhodamine WT standards are required in the future, perform another dilution of the concentrated dye solution after warming it to ambient temperature. Our experience has indicated that the concentrated solution that has been kept at cold temperatures is much more stable than the dilute solution stored at room temperature.

EFFECT OF TURBIDITY ON RHODAMINE WT READINGS

As described above, the filters in front of the photodiode in the YSI 6130 rhodamine probe prevent most of the green light which is used to excite the rhodamine molecules from reaching the detector after being backscattered off of non-fluorescent particles (turbidity) in environmental water. However, the filter system is not perfect and a minor interference on rhodamine WT readings from suspended solids may result. Laboratory experiments indicate that a suspension of typical soil measured with a YSI 6026 sensor will have turbidity interference characterized by a factor of about 0.03 $\mu\text{g/L}$ per NTU. For example, the turbidity of the water must be above 100 NTU to produce an apparent rhodamine WT reading equal to 3 $\mu\text{g/L}$. In very cloudy water, the user may wish to use the independently-determined turbidity value and the above compensation factor to correct measured chlorophyll values using, for example, a spreadsheet.

EFFECT OF CHLOROPHYLL ON RHODAMINE WT READINGS

While the green LED used in the rhodamine WT sensor is not ideal for excitation of the chlorophyll in phytoplankton, some fluorescence of environmental chlorophyll will always be induced by the rhodamine sensor. Because the filter system for the rhodamine photodiode is not perfect in excluding chlorophyll fluorescence, a minor interference on rhodamine WT readings from phytoplankton may result. Laboratory experiments indicate that a suspension of phytoplankton measured with a YSI 6025 sensor will have chlorophyll interference characterized by a factor of about 0.10 $\mu\text{g/L}$ Rhodamine WT per $\mu\text{g/L}$ of chlorophyll. For example, the chlorophyll content of the water must be above 30 $\mu\text{g/L}$ chlorophyll to produce an apparent rhodamine WT reading equal to 3 $\mu\text{g/L}$. In water with a high algal content, the user may wish to use the independently-determined chlorophyll value and the above compensation factor to correct measured rhodamine values using, for example, a spreadsheet.

SECTION 6 TROUBLESHOOTING

This section contains troubleshooting tables that will be helpful to identify the causes of the most common difficulties that may occur while operating the YSI 6-Series Sondes. The **Symptom** column describes the type of difficulty that you might experience. The **Possible cause** column describes the conditions that might cause the stated symptom. The **Action** column provides simple steps that can be followed to correct for the "possible cause" and cure the "symptom" being experienced. The column entitled **Ref** is the number of the reference section and subsection in the manual where you may find additional information.

Troubleshooting problems have been categorized into four general areas.

- Calibration Error Messages
- Sonde Communication
- Sensor Performance

If you need assistance that this Troubleshooting section can not provide, please contact YSI or your authorized dealer. See **Appendix C, Accessories and Calibration Standards**, for specific contact information.

6.1 CALIBRATION ERRORS

There are only three Calibration Error messages that are possible and are listed below, instead of in the troubleshooting table. Only two of the error messages are related to sensor performance.

High Free Chlorine Charge: This message indicates a malfunction in the free chlorine sensor that is generally due to the roughness of the electrodes on the surface of the probe face. The charge associated with the chlorine sensor must be in the range 0 to 75 or the error message will appear when calibration is attempted. If this error message is encountered, remove the free chlorine probe from the sonde and resurface it according to the instructions in **Section 2.3.1** of this manual. Then install a new membrane and activate the sensor as described in the same section. After resurfacing, allow the sensor to pulse in the Run mode for at least 1 hour, during which time the DO charge may be expected to drop in value if the sensor is still functional. If resurfacing does not result in a lowering of the charge, contact YSI Customer Service for additional help.

Out of Range: This message indicates that the output of the sensor being calibrated does not conform to the normal range for this parameter. This problem could be due to either a malfunctioning sensor or to a calibration solution that is out of specification. If this error message is encountered, first insure that your standards for pH, ORP, ammonium, nitrate, chloride, conductivity, and turbidity have not been contaminated and that your free chlorine sensor is in flowing tap water in a YSI flow cell. If an Out of Range error is experienced for free chlorine, also be certain that you have correctly determined the chlorine content of your flow cell effluent with a DPD colorimetric analysis and that your colorimeter is working properly. Perform replicate analyses of the effluent to assure correct chlorine content. Also be certain that you have entered the correct value for the calibration solution. If the calibration error message continues to occur, change the membrane, reactivate the sensor, and retry the calibration. If still unsuccessful, contact YSI Customer Service to determine whether the sensor in question needs to be factory-serviced or replaced.

Illegal Entry: This message simply indicates that your keyboard input does not conform to the accepted format for this parameter. For example, you may have entered the "letter O" instead of "zero" for a calibration value. Return to the desired parameter in the Calibrate menu and repeat the calibration entry, being certain to enter only numbers.

The following troubleshooting tables can help you if you encounter problems with software, communication protocol, or sensor malfunctions other than calibration errors.

6.2 SONDE COMMUNICATION PROBLEMS

SYMPTOM	POSSIBLE CAUSE	ACTION	REF
Cannot communicate with sonde	Sonde not powered	Check 12 vdc source	7.2
	Cable connection is loose	Check both ends of cable; secure connectors	
	Damaged connectors	Check pins at both ends, insure they are straight, dry and clean.	
	Com port not selected	Change to other com port, other peripheral on the same port (Internal mouse). Try other PC, 650 display/logger or dumb terminal	2.4.3
Scrambled data	Unmatched baud rate between host and sonde	Match the baud rate	2.4.3
	Host is too slow	Use faster computer	
	Interface cable failure	Check cable for damage. If necessary, return for service	7
	Internal failure	Return sonde for service	7

6.3 SENSOR PERFORMANCE PROBLEMS

SYMPTOMS	POSSIBLE CAUSE	ACTION	REF
Free Chlorine reading unstable or inaccurate	Probe not properly calibrated	Follow chlorine cal procedures	2.6.1
	Membrane not properly installed or may be punctured	Follow 6572 setup procedure	2.3.1
	DO probe electrodes require cleaning	Follow cleaning procedure. Use 6035 maint. kit	2.10.2
	Water in probe connector	Dry connector; reinstall probe	2.3.2
	Chlorine Charge too high >30 1. Anode tarnished	Follow cleaning procedure. Use 6035 maintenance kit	2.7 2.10.2
	DO probe has been damaged	Replace 6572 probe	8/C
	Internal failure	Return sonde for service	8
pH, ORP, chloride, ammonium, or nitrate readings are unstable or inaccurate. Error messages appear during calibration.	Probe requires cleaning	Follow probe cleaning procedure	2.10.2
	Probe requires calibration	Follow cal procedures	2.6.1 3.7.4
	pH probe reference junction has dried out from improper storage.	Soak probe in tap water or buffer until readings become stable	2.10.2
	Water in probe connector	Dry connector; reinstall probe	2.3.2
	Probe has been damaged	Replace probe	8/C
	Calibration solutions out of spec or contaminated with other solution	Use new calibration solutions	C
	ORP fails Zobell check	Take into account temperature dependence of Zobell solution readings	5.3
Internal failure	Return sonde for service	8	

Depth unstable or inaccurate	Depth sensor has not been zeroed	Follow depth zero procedure	2.6.1
	Depth sensor access hole is obstructed	Follow depth cleaning procedure	2.10.2
	Depth sensor has been damaged	Return sonde for service	8
	Internal failure	Return sonde for service	8
Conductivity unstable or inaccurate. Error messages appear during calibration.	Conductivity improperly calibrated.	Follow cal procedure	2.6.1
	Conductivity probe requires cleaning	Follow cleaning procedure	2.10.2
	Conductivity probe damaged	Replace probe	8/C
	Calibration solution out of spec or contaminated	Use new calibration solution	C
	Internal failure	Return sonde for service	8
	Calibration solution or sample does not cover entire sensor.	Immerse sensor fully.	2.6.1
Installed probe has no reading	The sensor has been disabled	Enable sensor	2.9.5
	Water in probe connector	Dry connector; reinstall probe	2.10.1
	Probe has been damaged	Replace the 6560 probe	8/C
	Report output improperly set up	Set up report output	2.9.4
	Internal failure	Return sonde for service.	8
Temperature, unstable or inaccurate	Water in connector	Dry connector; reinstall probe	2.10.2
	Probe has been damaged	Replace the 6560 probe	8/C
Turbidity probe unstable or inaccurate. Error messages appear during calibration	Probe requires cleaning.	Follow probe cleaning procedure	2.10.2
	Probe requires calibration	Follow cal procedures	8.4
	Probe has been damaged	Replace probe	8
	Water in probe connector	Dry connector; reinstall probe	2.3.2
	Calibration solutions out of spec	Use new calibration solutions	C
	Wiper is not turning or is not synchronized.	Activate wiper. Assure rotation. Make sure setscrew is tight.	2.10.2
	Wiper is fouled or damaged.	Clean or replace wiper.	2.10.2
	Internal failure.	Return probe for service.	8

SECTION 7 COMMUNICATION

This section describes the communication protocols that the Sondes use to communicate with the host system. **Section 7.1** gives a brief overview of the communication ability of the Sondes. The remaining sections describe available hardware and software features.

7.1 OVERVIEW

The sondes communicate via a serial port that can be configured as either a SDI-12, or a 3-wire RS-232 interface. The normal mode of operation for the sonde is RS-232, with the following configurations:

Baud rate: 300, 600, 1200, 2400, 4800, 9600
 Data Bit: 8
 Parity: None
 Handshake: None

For further detail into the sondes RS-232 and SDI-12 implementations, see **Sections 7.3 and 7.4** respectively.

With these configurations, the Sonde is capable of interfacing to a variety of devices from a “dumb” terminal to numerous data collection platforms.

7.2 HARDWARE INTERFACE

Connection from the Sonde to the host computer is provided using the YSI 6095B MS-8 to DB-9 female adapter. This 6095B then connects to the standard DB-9 male connector on the host computer. The Sonde PC interface cable is wired for direct connection to a DTE device. The following table defines the interface circuits. The signals and their directions are defined with respect to use of the Sonde with the 6095B adapter.

Wire Color	Pin Description	DB-9	MS-4	MS-8
Yellow	RS232 TX	2	----	C
Orange	RS232 RX	3	----	D
Green	Alarm	----	----	E
Grey	RTS	----	----	G
Blue	CTS	----	----	H
Red	+ 12V DC	9	A	A
Black	GND	5	C	B
Purple	SDI-12	----	B	F
Bare	Shield	----	----	B

7.3 RS-232 INTERFACE

The sonde has an auto-baud feature that allows the instrument to automatically adjust to the terminal baud rate. If the sonde is set to a baud rate of 4800 and a 9600 baud terminal is attached to it, after a few carriage returns are entered, the sonde will recognize the communication mismatch and attempt to change its own internal baud rate to match the terminals.

7.4 SDI-12 INTERFACE

SDI-12 is an industry-standard serial digital interface bus. The bus was designed to allow compatibility between data collection devices and sensors of various manufacturers. The description below applies specifically to the Sonde implementation of SDI-12 interface. For complete SDI-12 technical specifications please contact:

Campbell Scientific, Inc.
 P.O. Box 551
 Logan, Utah 84321 USA
 (801) 753-2342

SDI-12 is a single master multi-drop bus and command protocol. As many as 10 sensors can be connected to the bus at a time. Each sensor is pre-assigned a unique address from 0 to 9. Each Sonde is factory-set to address 0. The address can be changed in the System menu, **see Section 2.9.5, System menu** for details.

Running the sonde in SDI-12 mode requires it to be connected to a SDI-12 master device. An example of such a device is the YSI 6200 or units from Campbell Scientific or Handar Instruments. These instruments provide the commands necessary to communicate with the sonde in SDI-12 mode. In addition, the sonde also supports the following commands which are entered from the command line at the # prompt:

SDI12

This command activates SDI-12 mode. This is the only mode in which the Sonde will respond to any SDI-12 command. To exit to command line, press any key from the terminal connected to the RS-232 port.

The Sonde implements the basic SDI-12 command set. Below are the descriptions of each command and their responses.

The following notations are used:

- a** Sonde SDI-12 address (ASCII '0' to '9')
- [CR]** Carriage return (ASCII 13)
- [LF]** Line feed (ASCII 10)
- Master** Any SDI-12 compatible data collection device

Master:	aM!	Initiate a measurement.
Sonde:	atttn[CR] [LF]	

ttt - Maximum time in seconds the Sonde will take to complete the measurement.

n - Number of data that will be available when the measurement is completed. This number is the same as the number of output parameters set in the Report menu, as described in **Section 2.9.6, Report**. For ten or more parameters, the sonde returns ":", ";", "<", "=", ">", "?", "@", "A", "B",...etc.

After finishing the measurement, the Sonde will usually send a service request "a[CR][LF]" to the bus master. The bus master can then retrieve the measurement result by "D0" to "D9" commands (see below). If the Sonde does not send a service request within the specified maximum time, the measurement is canceled. The bus master can then restart with another "M" command.

```
Master:          aI!          Send identification.
Sonde:          allccccccmmmmmmvvvxxx...xxx[CR][LF]
```

l - 2 character SDI-12 level number.

c - 8 character manufacturer identification. This field always contains "YSIIWQSG" (YSI Inc., Water Quality Systems Group).

m - 6 character model number. This field always contains "EM600_" or "EM 6920" (Environmental Monitoring System Sonde) depending on the sonde.

v - 3 character version number. This field holds the sonde's software version number ("100" for version 1.00).

```
Master:          aD0! to aD9!
Retrieve measurement/verifying data
Sonde:          a<values>[CR][LF]
```

<values>- 33 characters or less. This field holds one or more values resulting from a measurement or verifying sequence. A value contains between 1 to 7 digits with an optional radix mark (period '.' or comma ','). Each value must be preceded by its sign (either '+' or '-') since the sign is also used to delimit multiple values.

If the number of values returned by the "D0" command is less than the number specified in the previous response to "M" commands, the rest of the data can be retrieved by using "D1" to "D9" commands. The "D" commands are non-destructive. Thus if the same "D" command is issued multiple times before the next "M" command, it will return the same data. If the response to the "D0" command is "a[CR][LF]" then either no "M" command was received before the first "D" command or the "M" command was canceled.

Example: Here is an example SDI-12 transaction. Here SDI-12 master will issue an Identify command followed by a Measure command. The sonde is configured with a report output of Temperature, Specific conductance, DO %, DO mg/L, pH (ISE1), ORP (ISE2), and Depth, a DO warm up time of 60 seconds, and an SDI-12 address of 1.

Master: II!

Sonde: 110YSIIWQSGEM600_107[CR][LF]

The bus master asked for identification and the Sonde returned data showing the following.

```
SDI-12 level:  1.0
Manufacturer:  YSIIWQSG
```

Model: EMS600_
Version: 1.07

Master: 1M!

Sonde: 10617[CR][LF]

The bus master sent a measurement command. The Sonde will take a maximum of 61 seconds to finish the measurement. Upon completion, it will have 7 sensor data available.

Sonde: 1[CR][LF]

Master: 1D0!

Sonde: 1+17.5+12.05+98.7+8.25+6.45[CR][LF]

Master: 1D1!

Sonde: 1-325+10[CR][LF]

After finishing the measurement, the Sonde sent a service request to indicate completion. The bus master then sent the "D0" command to retrieve the data. There were 5 data returned. Since 7 readings should be available, the master continued with "D1" command and received the remaining data. The responses from "D0" and "D1" commands are:

Temperature:	17.5
Specific conductance:	12.05
DO %:	98.7
DO mg/L:	8.25
pH (ISE1):	6.45
ORP (ISE2):	-325
Depth:	10

SECTION 8 WARRANTY AND SERVICE INFORMATION

The sondes are warranted for two years and the 650 MDS for three years against defects in workmanship and materials when used for their intended purposes and maintained according to instructions. All cables are warranted for one year. The free chlorine, temperature/conductivity, turbidity, chlorophyll, rhodamine WT, pH, pH/ORP, and chloride probes are warranted for 1 year. Ammonium and nitrate probes are warranted for six months. Damage due to accidents, misuse, tampering, or failure to perform prescribed maintenance is not covered. The warranty period for chemicals and reagents is determined by the expiration date printed on their labels. Within the warranty period, YSI will repair or replace, at its sole discretion, free of charge, any product that YSI determines to be covered by this warranty.

To exercise this warranty, write or call your local YSI representative, or contact YSI Customer Service in Yellow Springs, Ohio. Send the product and proof of purchase, transportation prepaid, to the Authorized Service Center selected by YSI. Repair or replacement will be made and the product returned transportation prepaid. Repaired or replaced products are warranted for the balance of the original warranty period, or at least 90 days from date of repair or replacement.

8.1 LIMITATION OF WARRANTY

This Warranty does not apply to any YSI product damage or failure caused by (i) failure to install, operate or use the product in accordance with YSI's written instructions, (ii) abuse or misuse of the product, (iii) failure to maintain the product in accordance with YSI's written instructions or standard industry procedure, (iv) any improper repairs to the product, (v) use by you of defective or improper components or parts in servicing or repairing the product, or (vi) modification of the product in any way not expressly authorized by YSI.

THIS WARRANTY IS IN LIEU OF ALL OTHER WARRANTIES, EXPRESSED OR IMPLIED, INCLUDING ANY WARRANTY OF MERCHANTABILITY OR FITNESS FOR A PARTICULAR PURPOSE. YSI'S LIABILITY UNDER THIS WARRANTY IS LIMITED TO REPAIR OR REPLACEMENT OF THE PRODUCT, AND THIS SHALL BE YOUR SOLE AND EXCLUSIVE REMEDY FOR ANY DEFECTIVE PRODUCT COVERED BY THIS WARRANTY. IN NO EVENT SHALL YSI BE LIABLE FOR ANY SPECIAL, INDIRECT, INCIDENTAL OR CONSEQUENTIAL DAMAGES RESULTING FROM ANY DEFECTIVE PRODUCT COVERED BY THIS WARRANTY.

8.2 AUTHORIZED SERVICE CENTERS

YSI has authorized service centers throughout the United States and Internationally. For information about the YSI Service Center nearest to you, please visit www.ysi.com/envrironmental and click “Tech Support”. Alternatively, you can contact YSI Technical Support directly at 800-897-4151.

8.3 CLEANING INSTRUCTIONS

NOTE: Before they can be serviced, equipment exposed to biological, radioactive, or toxic materials must be cleaned and disinfected. Biological contamination is presumed for any instrument, probe, or other device that has been used with body fluids or tissues, or with wastewater. Radioactive contamination is presumed for any instrument, probe or other device that has been used near any radioactive source.

If an instrument, probe, or other part is returned or presented for service without a Cleaning Certificate, and if in our opinion it represents a potential biological or radioactive hazard, our service personnel reserve the right to withhold service until appropriate cleaning, decontamination, and certification has been completed. We will contact the sender for instructions as to the disposition of the equipment. Disposition costs will be the responsibility of the sender.

When service is required, either at the user's facility or at YSI, the following steps must be taken to insure the safety of our service personnel.

- ☞ In a manner appropriate to each device, decontaminate all exposed surfaces, including any containers. 70% isopropyl alcohol or a solution of 1/4 cup bleach to 1-gallon tap water are suitable for most disinfecting. Instruments used with wastewater may be disinfected with .5% Lysol if this is more convenient to the user.
- ☞ The user shall take normal precautions to prevent radioactive contamination and must use appropriate decontamination procedures should exposure occur.
- ☞ If exposure has occurred, the customer must certify that decontamination has been accomplished and that no radioactivity is detectable by survey equipment.
- ☞ Any product being returned to the YSI Repair Center, should be packed securely to prevent damage.
- ☞ Cleaning must be completed and certified on any product before returning it to YSI.

PACKING INSTRUCTIONS

- ☞ Clean and decontaminate items to insure the safety of the handler.
- ☞ Complete and include the Cleaning Certificate.
- ☞ Place the product in a plastic bag to keep out dirt and packing material.
- ☞ Use a large carton, preferably the original, and surround the product completely with packing material.
- ☞ Insure for the replacement value of the product.

Cleaning Certificate	
Organization _____	
Department _____	
Address _____	
City _____	State ___ Zip _____
Country _____	Phone _____
Model No. of Device _____	Lot Number _____
Contaminant (if known) _____	
Cleaning Agent(s) used _____	
Radioactive Decontamination Certified?	
(Answer only if there has been radioactive exposure) . Yes ____	
No	
Cleaning Certified By _____	
Name	Date

APPENDIX A HEALTH AND SAFETY

NOTE: For additional health, safety, and disposal information about YSI reagents, download the MSDS documents for the chemical in question from the YSI webpage (ysi.com).

YSI Conductivity solutions: 3161, 3163, 3165, 3167, 3168, 3169

INGREDIENTS:

- Iodine
- Potassium Chloride
- Water

Inhalation:

Inhalation of mist or splashes of iodine solution can cause severe irritation, with potential destruction of respiratory tissues, spasms, and edema (choking) in throat and lungs, depending on frequency and degree of exposure. Other reported potential effects are coughing, burning sensation, laryngitis, headache, and nausea.

Use a NIOSH approved respirator for liquid mists and/or splashes. Get supplier recommendations. Provide adequate ventilation. Avoid conditions that cause misting or splashing.

Remove to fresh air. Give artificial respiration and get medical attention as needed.

Skin:

May cause irritation with repeated exposure.

Wear water-resistant gloves as needed.

Wash exposed areas with soap and water for 15 minutes. Remove contaminated clothing, and wash before re-using.

Eyes:

Can cause irritation and potential eye damage with repeated exposure.

Wear splash-proof water-resistant goggles. Have convenient eyewash stations.

Flush with water for 15 minutes.

Ingestion

Can cause irritation of mouth, throat, and an upset stomach.

Wear a mouth cover or face shield when there is splashing.

Do not swallow. Rinse mouth. If swallowed, do not induce vomiting. Get prompt medical attention.

(No chronic effects reported)

IN ALL CASES: GET MEDICAL ATTENTION IF EFFECTS PERSIST.

Most likely routes of entry: skin, eyes, ingestion.

FIRST AID:

INHALATION: Remove victim from exposure area. Keep victim warm and at rest. In severe cases seek medical attention.

SKIN CONTACT: Remove contaminated clothing immediately. Wash affected area thoroughly with large amounts of water. In severe cases seek medical attention.

EYE CONTACT: Wash eyes immediately with large amounts of water, (approx. 10 minutes). Seek medical attention immediately.

INGESTION: Wash out mouth thoroughly with large quantities of water. Do not induce vomiting. Seek medical attention immediately.

YSI pH 4.00, 7.00, and 10.00 Buffer Solutions: 3821, 3822, 3823**pH 4 INGREDIENTS:**

- Potassium Hydrogen Phthalate
- Formaldehyde
- Water

pH 7 INGREDIENTS:

- Sodium Phosphate, Dibasic
- Potassium Phosphate, Monobasic
- Water

pH 10 INGREDIENTS:

- Potassium Borate, Tetra
- Potassium Carbonate
- Potassium Hydroxide
- Sodium (di) Ethylenediamine Tetraacetate
- Water

CAUTION - AVOID INHALATION, SKIN CONTACT, EYE CONTACT OR INGESTION. MAY AFFECT MUCOUS MEMBRANES.

Inhalation may cause severe irritation and be harmful. Skin contact may cause irritation; prolonged or repeated exposure may cause Dermatitis. Eye contact may cause irritation or conjunctivitis. Ingestion may cause nausea, vomiting and diarrhea.

FIRST AID:

INHALATION - Remove victim from exposure area to fresh air immediately. If breathing has stopped, give artificial respiration. Keep victim warm and at rest. Seek medical attention immediately.

SKIN CONTACT - Remove contaminated clothing immediately. Wash affected area with soap or mild detergent and large amounts of water (approx. 15-20 minutes). Seek medical attention immediately.

EYE CONTACT - Wash eyes immediately with large amounts of water (approx. 15-20 minutes), occasionally lifting upper and lower lids. Seek medical attention immediately.

INGESTION - If victim is conscious, immediately give 2 to 4 glasses of water and induce vomiting by touching finger to back of throat. Seek medical attention immediately.

YSI Zobell Solution: 3682**INGREDIENTS:**

- Potassium Chloride
- Potassium Ferrocyanide Trihydrate
- Potassium Ferricyanide

CAUTION - AVOID INHALATION, SKIN CONTACT, EYE CONTACT OR INGESTION. MAY AFFECT MUCOUS MEMBRANES.

May be harmful by inhalation, ingestion, or skin absorption. Causes eye and skin irritation. Material is irritating to mucous membranes and upper respiratory tract. The chemical, physical, and toxicological properties have not been thoroughly investigated.

Ingestion of large quantities can cause weakness, gastrointestinal irritation and circulatory disturbances.

FIRST AID:

INHALATION - Remove victim from exposure area to fresh air immediately. If breathing has stopped, give artificial respiration. Keep victim warm and at rest. Seek medical attention immediately.

SKIN CONTACT - Remove contaminated clothing immediately. Wash affected area with soap or mild detergent and large amounts of water (approx. 15-20 minutes). Seek medical attention immediately.

EYE CONTACT - Wash eyes immediately with large amounts of water (approx. 15-20 minutes), occasionally lifting upper and lower lids. Seek medical attention immediately.

INGESTION - If victim is conscious, immediately give 2 to 4 glasses of water and induce vomiting by touching finger to back of throat. Seek medical attention immediately.

YSI Ammonium Standard Solutions: 3841, 3842, and 3843**INGREDIENTS:**

- Ammonium Chloride
- Lithium Acetate Dihydrate
- Sodium Azide (trace)
- Hydrochloric acid

CAUTION - AVOID INHALATION, SKIN CONTACT, EYE CONTACT OR INGESTION. MAY AFFECT MUCOUS MEMBRANES.

May be harmful by ingestion or skin absorption. May cause eye and skin irritation. The chemical, physical, and toxicological properties have not been thoroughly investigated.

Ingestion of large quantities of lithium salts can affect the central nervous system producing symptoms ranging from dizziness to collapse. It may also cause kidney damage, nausea, and anorexia. Note that the ingestion of harmful quantities from the solutions is considered unlikely given the low concentration of lithium and the volumes likely to be handled.

FIRST AID:

INHALATION - Remove to fresh air. If not breathing, give artificial respiration. If breathing is difficult, give oxygen. Call a physician.

SKIN CONTACT - Remove contaminated clothing immediately. Wash affected area with soap or mild detergent and large amounts of water (approx. 15-20 minutes).

EYE CONTACT - Wash eyes immediately with large amounts of water (approx. 15-20 minutes), occasionally lifting upper and lower lids. Seek medical attention immediately.

INGESTION - Immediately rinse out mouth with large quantities of water. If reagent was swallowed, give 2 glasses of water and seek medical attention immediately.

YSI Nitrate Standard Solutions: 3885, 3886, and 3887**INGREDIENTS**

- Potassium Nitrate
- Magnesium Sulfate
- Gentamycin Sulfate (Trace)

CAUTION - AVOID INHALATION, SKIN CONTACT, EYE CONTACT OR INGESTION.

May be harmful by ingestion or skin absorption. May cause eye and skin irritation. The chemical, physical, and toxicological properties have not been thoroughly investigated.

FIRST AID:

INHALATION - Remove to fresh air. If not breathing, give artificial respiration. If breathing is difficult, give oxygen. Call a physician.

SKIN CONTACT - Remove contaminated clothing immediately. Wash affected area with soap or mild detergent and large amounts of water (approx. 15-20 minutes).

EYE CONTACT - Wash eyes immediately with large amounts of water (approx. 15-20 minutes), occasionally lifting upper and lower lids. Seek medical attention immediately.

INGESTION - Immediately rinse out mouth with large quantities of water. If irritation occurs or reagent was swallowed, seek medical attention immediately.

YSI Turbidity Standard: 6073

INGREDIENTS

- Styrene divinylbenzene copolymer spheres

The material is not volatile and has no known ill effects on skin, eyes, or on ingestion. Therefore, no special precautions are required when using the standards. General precautions should be adopted as required with all materials to minimize unnecessary contact. Note, however, that the chemical, physical, and toxicological properties have not been thoroughly investigated.

FIRST AID:

SKIN CONTACT - Remove contaminated clothing. Wash affected area with soap or mild detergent and water.

EYE CONTACT - Wash eyes immediately with large amounts of water (approx. 15-20 minutes), occasionally lifting upper and lower lids. If irritation occurs, seek medical attention immediately.

INGESTION - Rinse out mouth with large quantities of water. If irritation occurs or reagent was swallowed, seek medical attention as a precaution.

YSI Replacement Desiccant 065802

INGREDIENTS

- Calcium Sulfate and Calcium Chloride

CAUTION - AVOID INHALATION, SKIN CONTACT, EYE CONTACT OR INGESTION. MAY AFFECT MUCOUS MEMBRANES.

FIRST AID:

SKIN CONTACT - Flush with water.

EYE CONTACT - Flush with water. If irritation continues, obtain medical attention.

INGESTION - If patient is conscious, induce vomiting. Obtain medical attention.

APPENDIX B REQUIRED NOTICE

The Federal Communications Commission defines this product as a computing device and requires the following notice.

This equipment generates and uses radio frequency energy and if not installed and used properly, may cause interference to radio and television reception. It has been type tested and found to comply with the limits for a Class A or Class B computing device in accordance with the specification in Subpart J of Part 15 of FCC Rules, which are designed to provide reasonable protection against such interference in a residential installation. However, there is no guarantee that interference will not occur in a particular installation. If this equipment does cause interference to radio or television reception, which can be determined by turning the equipment off and on, the user is encouraged to try to correct the interference by one or more of the following measures:

- Reorient the receiving antenna
- Relocate the computer with respect to the receiver
- Move the computer away from the receiver
- Plug the computer into a different outlet so that the computer and receiver are on different branch circuits.

If necessary, the user should consult the dealer or an experienced radio/television technician for additional suggestions. The user may find the following booklet, prepared by the Federal Communications Commission, helpful: "How to Identify and Resolve Radio-TV Interference Problems". This booklet is available from the U.S. Government Printing Office, Washington, D.C. 20402, Stock No.0004-000-00345-4.

APPENDIX C ACCESSORIES AND CALIBRATION STANDARDS

STANDARD EQUIPMENT WITH YSI SONDES

- 600DW-B or 6920DW Sonde With Calibration Cup and Probe Guard
- EcoWatch for Windows Software
- Operations Manual
- 6570 Maintenance Kit
- 6560 Conductivity/Temperature Probe
- 6574 Membrane Installation Kit

PROBES FOR THE SONDES

- 6572 Free Chlorine Probe with 6573 Membrane Kit and 6035 Reconditioning Kit
- 6560 Conductivity/Temperature Probe
- 6561 pH Probe
- 6565 Combination pH/ORP Probe
- 6566 Combination pH/ORP Probe, Fouling Resistant
- 6561FG pH Probe with Flat Glass
- 6565FG Combination pH/ORP Probe with Flat Glass
- 6136 Turbidity Probe, wiped
- 6025 Chlorophyll Probe, wiped
- 6130 Rhodamine WT Probe, wiped
- 6882 Chloride Probe
- 6883 Ammonium Probe
- 6884 Nitrate Probe

OPTIONAL ACCESSORIES FOR THE SONDES

- 655488 Extended Calibration Cup Sleeve for 6920DW
- 655423 Spare Probe Installation Tool
- 6627 Turbidity Wiper Kit for 6136
- 6024 Chlorophyll Wiper Kit for 6025
- 6624 Chlorophyll Wiper Kit for 6025, #2-56 set screw
- 6144 Optical Wiper Pad Kit for 6627, 6024, and 6624 Wiper Assemblies
- 6035 Probe Reconditioning Kit for 6572 Free Chlorine and 6562 Dissolved Oxygen Probes
- 6038 12 VDC Power Supply with 110 VAC input
- 6651 12 VDC Power Supply with Universal input
- 6081 Carrying Case
- 6570 Maintenance Kit
- 6573 Free Chlorine Membrane Kit

FLOW CELLS FOR THE SONDES

- 5083 Flow Cell for 600DW-B
- 6160 Flow Cell for 6920DW

CABLES FOR THE SONDES

- 6093 Field Cable, 100 ft (30 m)
- 6092 Field Cable, 50 ft (15 m)
- 6091 Field Cable, 25 ft (7.5 m)
- 6090 Field Cable, 8 ft (2.4 m)
- 6067B Low Cost Calibration Cable, Dry use only; 10 ft (3m)
- 6077B CE Calibration Cable, 10 ft. (3m)
- SP6093-L Special field cables available in 25 ft(7.6 m) increments; Maximum 1000 ft (305m)
- 6096 Field Cable to Flying Lead (wire) adapter, 15 ft (5m)
- 6095B Field Cable to Female DB-9 (PC Serial with Power Connector)
- 6100 External Power Connector, attaches to 6095B Field Cable (6ft)
- 6103 MS-8 Dust Cover (caps connector when not in use)

CONDUCTIVITY REAGENTS

- 3161 Calibrator Solution, 1,000 uS/cm (quart)
- 3163 Calibrator Solution, 10,000 uS/cm (quart)
- 3165 Calibrator Solution, 100,000 uS/cm (quart)
- 3167 Calibrator Solution, 1,000 uS/cm (box of 8 pints)
- 3168 Calibrator Solution, 10,000 uS/cm (box of 8 pints)
- 3169 Calibrator Solution, 50,000 uS/cm (box of 8 pints)

pH REAGENTS

- 3821 pH 4 Buffer (box of 6 pints)
- 3822 pH 7 Buffer (box of 6 pints)
- 3823 pH 10 Buffer (box of 6 pints)
- 3824 Assorted pH Buffer Kit (2 bottles of pH 4, pH 7 and pH 10 buffers)

ORP REAGENTS

- 3682 Zobell Solution (125 ml)

AMMONIUM REAGENTS

- 3841 1 mg/L ammonium-nitrogen standard solution
- 3842 10 mg/L ammonium-nitrogen standard solution
- 3843 100 mg/L ammonium-nitrogen standard solution

NITRATE REAGENTS

- 3885 1 mg/L nitrate-nitrogen standard solution
- 3886 10 mg/L nitrate-nitrogen standard solution
- 3887 100 mg/L nitrate-nitrogen standard solution

TURBIDITY REAGENTS

- 6080 0 NTU standard suspension, 1 gal
- 6072 10 NTU standard suspension, 1 gal
- 6073 100 NTU standard suspension, 500 mL
- 6073G 100 NTU standard suspension, 1 gal
- 6074 1000 NTU standard suspension, 1 gal

DISPLAYS, LOGGERS, AND ACCESSORIES

- 650-01 – Low memory with no barometer
- 650-02 – High memory with no barometer
- 650-03 – Low memory with barometer
- 650-04 – High memory with barometer
- 6112 PC Interface Cable. PC to 650 MDS.
- 6113 Rechargeable Battery Pack Kit with 6116 charger adapter cable, 6114 110 volt wall charger, and 6117 battery pack included
- 6126 Rechargeable Battery Pack Kit with 6116 charger adapter cable, 6123 universal charger, European power cable, British power cable, and 6117 battery pack included
- 6127 Rechargeable Battery Pack Kit with 6116 charger adapter cable, 6123 universal charger, China/Australia power cord, and 6117 battery pack included
- 4654 Tripod
- 614 Ultra Clamp
- 5085 Hands Free Harness
- 5065 Form-fitting Case
- 5081 Hard-sided Case
- 6117 Extra Rechargeable Battery Pack
- 6115 GPS Cable for interface with user-supplied GPS unit
- 616 Cigarette Lighter Charger

LOGGER/TELEMETRY

- 6200 Data Acquisition System (6200 DAS) and Accessories. Contact Endeco/YSI (1-800-363-3269) for options and ordering information.

SOFTWARE

- 6075 EcoWatch for Windows for use with 6-series applications; also available at no cost from the ysi.com website.
- 062781 PC6000 Software (Available at no cost), DOS-Based
- Software upgrades for sondes and 650 – See ysi.com website

APPENDIX D EMC PERFORMANCE

When using the YSI drinking water sondes in a European Community (CE) country, please be aware that electromagnetic compatibility (EMC) performance issues may occur under certain conditions, such as when the sonde is exposed to certain radio frequency fields.

If you are concerned with these issues, consult the Declaration of Conformity that was enclosed with your instrument. Specific conditions where temporary sensor problems may occur are listed in this document.

If you are unable to locate the Declaration of Conformity that was shipped with your instrument, contact your local YSI representative, or YSI Customer Service in Yellow Springs, Ohio for a copy of the document. See **Section 8, Warranty and Service Information** for contact information.

APPENDIX E SPECIFICATIONS

SONDE SPECIFICATIONS

600DW-B SONDE

Available Sensors	Temperature, Conductivity, Free Chlorine, pH, and ORP
Operating Environment	
Medium:	fresh, sea, or polluted water
Temperature:	-5 to +45 °C
Storage Temperature:	-40 to +60 °C for sonde and all sensors except pH and pH/ORP -20 to +60 °C for pH and pH/ORP sensors
Material:	PVC, Stainless Steel
Diameter:	1.65 inches (4.2 cm)
Length:	21.3 inches (54.1 cm) with no depth
Weight:	1.48 pounds (0.67 kg) (with batteries)
Computer Interface:	RS-232C, SDI-12
Internal logging memory size:	384 kilobytes (150,000 individual parameter readings)
Power:	4 C-size Alkaline Batteries or External 12 VDC
Battery Life:	25 to 30 days at 20 C with a 15 minute logging interval and a 40 second dissolved oxygen warm up

6920DW SONDE

Available Sensors	Temperature, Conductivity, Free Chlorine, pH, ORP, Ammonium, Nitrate, Chloride, Turbidity or Chlorophyll, or Rhodamine WT
Operating Environment	
Medium:	fresh, sea, or polluted water
Temperature:	-5 to +45 °C
Storage Temperature:	-40 to +60 °C for sonde and all sensors except pH and pH/ORP -20 to +60 °C for pH and pH/ORP sensors
Material:	Polyurethane, PVC, Stainless Steel
Diameter:	2.9 inches (7.4 cm)
Length:	18.25 inches (46.4 cm)
Weight:	3.74 pounds (1.7 kg) with sensors
Computer Interface:	RS-232C, SDI-12

Internal logging memory size:	384 kilobytes (150,000 individual parameter readings)
Power:	8 AA-size Alkaline Batteries or External 12 VDC
Battery Life:	Approximately 30 days at 20 °C at 15 minute logging intervals, a 40 second DO warm up time and turbidity, chlorophyll, or rhodamine-WT active

SENSOR SPECIFICATIONS

The following are typical performance specifications for each sensor. Specifications do not include drift.

Temperature

Sensor Type.....Thermistor
 Range.....-5 to 45 °C
 Accuracy.....+/- 0.15 °C
 Resolution.....0.01 °C

Conductivity*

Sensor Type.....4 electrode cell with autoranging
 Range.....0 to 100 mS/cm
 Accuracy.....+/- 0.5% of reading + 0.001 mS/cm
 Resolution.....0.001 mS/cm to 0.1 mS/cm (range dependent)

Free Chlorine, mg/L

Sensor Type..... Rapid Pulse - Clark type, polarographic
 Range.....0 to 3 mg/L
 Accuracy..... +/- 15 % of the reading or 0.05 mg/L, whichever is greater; to maintain accuracy specification, flow must be at least 500 mL/min and pH should not change by more than +/- 0.3 units if the mean pH is between 8.5 and 9.3. The sensor will not function properly at pH values above 9.3
 Resolution.....0.01 mg/L

Salinity

Sensor Type.....Calculated from conductivity and temperature
 Range.....0 to 70 ppt
 Accuracy.....+/- 1.0% of reading or 0.1 ppt, whichever is greater
 Resolution.....0.01 ppt

pH

Sensor Type.....Glass combination electrode
 Range.....0 to 14 units
 Accuracy.....+/- 0.2 units
 Resolution.....0.01 units
 Depth.....200 meters

ORP

Sensor type..... Platinum button
 Range.....-999 to +999 mV

* Report outputs of specific conductance (conductivity corrected to 25 C), resistivity, and total dissolved solids are also provided. These values are automatically calculated from conductivity according to algorithms found in *Standard Methods for the Examination of Water and Wastewater* (Ed 1989).

Accuracy.....+/-20 mV
 Resolution.....0.1 mV

Turbidity

Sensor type..... Optical, 90 ° scatter, with mechanical cleaning
 Range..... 0 to 1000 NTU
 Accuracy..... +/- 2 % reading or 0.3 NTU, whichever is greater. Relative to calibration standards
 Resolution.....0.1 NTU

Chlorophyll

Sensor type..... Optical, fluorescence, with mechanical cleaning
 Range..... 0 to 400 µg/L Chl; 0-100 Percent Full Scale (% FS) Fluorescence Units
 Accuracy..... No specification provided
 Resolution.....0.1 µg/L Chl; 0.1 % FS

Rhodamine WT

Sensor type..... Optical, fluorescence, with mechanical cleaning
 Range..... 0 to 200 µg/L Rhodamine WT
 Accuracy..... +/- 5 % of the reading or 1 µg/L, whichever is greater
 Resolution.....0.1 µg/L Rhodamine WT

Nitrate-Nitrogen

Sensor Type.....Ion-selective electrode
 Range.....0-200 mg/L-N
 Accuracy.....+/- 10% of reading or 2 mg/L (whichever is greater)
 Resolution.....0.001 mg/L-N to 1 mg/L-N (range dependent)

Ammonium-Nitrogen

Sensor Type.....Ion-selective electrode
 Range.....0-200 mg/L-N
 Accuracy.....+/- 10% of reading or 2 mg/L (whichever is greater)
 Resolution.....0.001 mg/L-N to 1 mg/L-N (range dependent)

Ammonia-Nitrogen

Sensor Type.....Calculated from ammonium, pH and temperature
 Range.....0-200 mg/L-N
 Accuracy.....+/- 10% of reading or 2 mg/L (whichever is greater)
 Resolution.....0.001 mg/L-N to 1 mg/L-N (range dependent)

Chloride

Sensor Type.....Solid state ion-selective electrode
 Range.....0-1000 mg/L
 Accuracy.....+/- 15% of reading or 5 mg/L (whichever is greater)
 Resolution.....0.001 mg/L to 1 mg/L (range dependent)

SOFTWARE SPECIFICATIONS

EcoWatch for Windows (included)

IBM PC compatible computer with CD ROM drive and with a 386 processor (or better) running Windows software. Compatible with Windows 3.1, Windows 95, Windows 98, Windows ME, Windows NT and Windows 2000. Minimum RAM requirement: 4 megabytes

APPENDIX F

QUICK START GUIDE TO DRINKING WATER MONITORING

Introduction: This Quick Start guide is designed to allow users who are already familiar with the basic use of YSI 6-series sondes for surface or groundwater applications to get up and running quickly in drinking water applications. Users who have not previously used 6-series sondes should carefully read the 6-series sonde manual supplied with the drinking water sondes prior to beginning any studies and only use this Quick Start guide after a thorough understanding of the use of the YSI multiparameter instruments has been gained.

Description of YSI Drinking Water (DW) Sondes: The 6920DW and 600DW-B drinking water sondes have many identical features to other YSI 6-series instruments as detailed below:

- They interface to computers, the YSI 650 display/logger, the YSI 6500 process monitor, and data collection platforms.
- They utilize the same cables.
- The calibration of all sensors other than free chlorine is carried out in the same way.
- Discrete Sampling and Unattended Sampling studies are set up in the same way.

However, there are some key differences from the standard YSI 6-series sondes:

- The sonde contains a new circuit board which will allow the measurement of free chlorine instead of dissolved oxygen. At the present time, dissolved oxygen cannot be measured with DW sondes.
- The new free chlorine probe is very similar in appearance to the Rapid Pulse dissolved oxygen probe and is designed to fit in the “DO” port of the sonde. The free chlorine sensor will probably be ordered as an accessory with each DW sonde.
- The DW systems are designed for use in flow cell applications and the appropriate flow cell should have been ordered with your DW sonde. The sonde can be used in drinking water tanks without the flow cell, but the flow dependence of the free chlorine sensor may result in a significant compromise in accuracy under these conditions.
- The free chlorine probe must be calibrated in situ versus a known chlorine value – usually determined from a DPD analysis.
- The membrane of the free chlorine sensor is a different material (polyvinylidene fluoride) from that used with YSI dissolved oxygen sensors (Teflon or polyethylene) and must be installed using special tools.
- The electrolyte used with the free chlorine sensor is different from that used with YSI dissolved oxygen sensors. Dissolved oxygen electrolyte should not be used with the free chlorine sensor.

Setting up DW Sondes For Drinking Water Studies:

- After unpacking the instrument and the flow cell, install all sensors EXCEPT free chlorine as described in Section 2.3 of the 6-series drinking water manual. Leave the port plug installed in the “DO” port of the sonde. The chlorine probe will be installed in this port at a later time.
- Access the **Advanced|Setup** menu of the sonde and make certain that the “Sample and Hold” feature is INACTIVE.
- Calibrate all sensors EXCEPT free chlorine according to standard procedures described in Section 2.5 of the 6-series drinking water sonde manual. Use the calibration vessel supplied with the sonde to hold the calibration reagents.

CAUTION: Make certain that the free chlorine sensor is not present in the sonde bulkhead when calibrating other sensors.

- Install the membrane for the free chlorine probe as described in Attachment 1 of this document and in Section 2.3 of the DW sonde manual. Proceed IMMEDIATELY to the next step to avoid the drying out of the free chlorine membrane and electrodes or store the probe in a beaker of tap water (not distilled or deionized) until proceeding to the next step.
- Now you MUST activate the sensor according to the following instructions:
 - Prepare a solution of free chlorine by diluting commercial bleach by a factor of 200. For example, add 1 mL of commercial bleach to 200 mL of water (purified or tap).
 - Place the sensor end of the probe in the bleach solution and leave for approximately 60 seconds.
 - After 60 seconds in the bleach solution, remove the sensor and rinse with purified water.

CAUTION: Use of more concentrated bleach solutions and/or exposure times longer than 60 seconds will cause a significant increase in the sensor break-in period and, in extreme cases, may cause damage to the sensor.

- Remove the port plug from the “DO” port in the sonde bulkhead and install the free chlorine probe according to the instructions in Section 2.3 of the manual. Be careful not to touch or damage the membrane.

CAUTION: The sensor should either be installed in the sonde bulkhead and immersed in water in the flow cell (see below) within 5 minutes after the activation process or the probe itself should be placed in a beaker of tap water. It is important that the probe does not dry out after activation

- Following the instructions in the flow cell kit supplied with your DW sonde, install the flow cell on to the sonde. Be sure the proper O-ring is in place on the sonde above the threads of the probe compartment.
- Attach a piece of tubing between your drinking water source and the bottom connector of the flow cell and another piece of tubing between the top connector of the flow cell and your drain. Open the water valve to allow a flow of 500-1000 mL per minute (minimum 500 mL/min). See picture below for a typical laboratory setup.

CAUTION: Make certain that both inlet and outlet holes are held securely in place at the flow cell fittings and at the inlet tap and drain. Failure to take these precautions can result in flooding and subsequent damage to your facility.

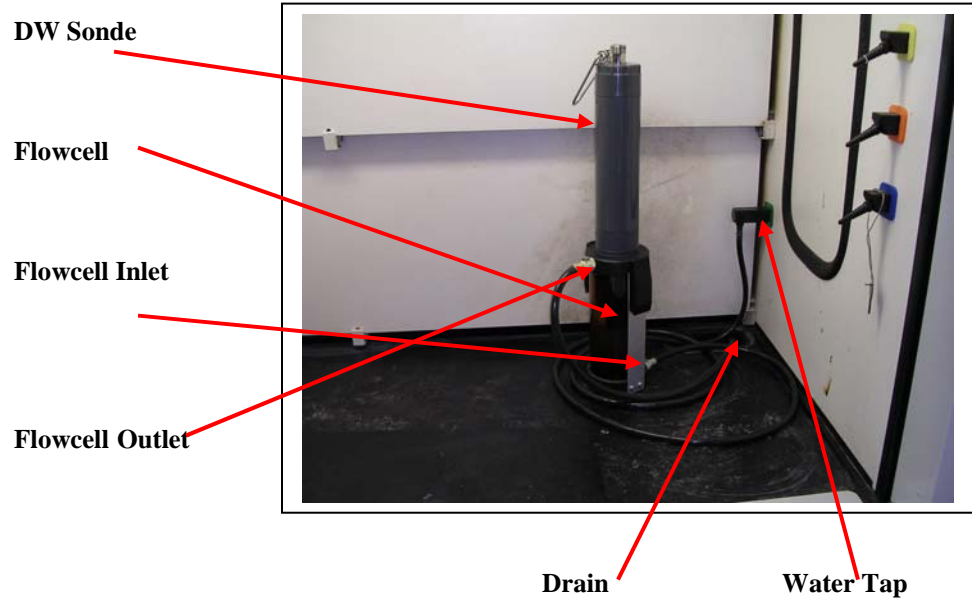

- Break in the free chlorine sensor by following the instructions below.
 - Interface to the sonde with a PC, YSI 650 Display/Logger, or 6500 Process Monitor as described in the manual.
 - For PC interface, select Run|Discrete Sample from the main menu and begin a study at a 4 second sample interval with data displayed on the PC monitor.
 - For 650 interface, select Sonde Run from the main menu and readings will automatically appear on the 650 display. Be sure that the “Shut off time” in the 650 System Setup menu is set to a value of zero so that the 650 maintains interface for the break-in period.
 - For a 6500 interface, plug in the 6500 and readings will automatically appear of the 6500 display.
 - Observe the displayed readings for at least 2 hours and make sure that they are relatively stable for a period of 1 hour. If possible, it is prudent to simply leave the sensor running continuously overnight to assure stability prior to calibration.
- Calibrate the sensor according to the instructions below depending on your sonde interface device.
 - Collect an effluent sample from the drain line of the flow cell.
 - Immediately determine the free chlorine content of the sample in mg/L using a DPD-based test kit such as the YSI 9100 or the Hach Pocket Colorimeter™ II.

- Immediately calibrate the free chlorine sensor in the sonde to the value just determined via DPD analysis. Interface to the sonde for calibration can be via PC, YSI 650 Display/Logger, or YSI 6500 Process Monitor.

- Start a Continuous Monitoring Study
 - For stand-alone applications, make sure that you have new batteries in your sonde and use a PC or 650 interface to set up an Unattended Sampling Study from the Run|Unattended menu at your desired sample interval and start the study. Under these conditions, data will be logged to the internal memory of the sonde for later upload using a computer or a 650 display/logger. The **Sample and Hold** feature found in the **Advanced|Setup** menu of the sonde should be INACTIVE for this type of application.

 - For applications involving the YSI 6500 Process Monitor applications, follow the procedure below. Consult **Appendix G, Using Your DW Sonde with the 6500 Process Monitor** or the manual supplied with the 6500 for more details:
 1. Make sure that the sonde is attached to the 6500 via a suitable YSI field cable.
 2. Make sure that the 6500 is attached to line power.
 3. Make sure that readings of all appropriate parameters are displayed on the screen.
 4. Connect the 4-20 mA current loop or modbus outputs of the 6500 to your SCADA system and assure proper data capture by the SCADA system.
 5. Determine whether you would like the readings output to your SCADA system to be continuous (NOT RECOMMENDED because higher frequency of free chlorine probe maintenance and potential compromise of pH/ORP sensor life) or frozen between longer sample intervals (RECOMMENDED because of lower frequency of free chlorine probe maintenance and longer pH/ORP probe life).
 6. If you choose continuous output to the SCADA, no further action is required.
 7. If you choose to use the recommended longer sample intervals, then enter the secondary menu of the 6500 by pressing the **Esc** and **Enter** keys simultaneously. Select **Setup sonde** from the menu and (a) activate the **Data Freeze and Release** function by pressing **Enter** to show a check mark in the box and (b) choose the sample interval between readings, pressing **Enter** after selecting the interval.
 8. Data should now be acquired by your SCADA system for processing according to user software.

Maintenance of the Chlorine Sensor During a Continuous Monitoring Study

- Inspect the flow cell, inlet and drain fittings and hose attachment points as often as possible and make certain no leaks are present. If leaks are observed, turn off the water at the inlet valve and make the necessary repairs to the fittings and/or tubing.

- Check the accuracy of the free chlorine sensor after approximately 2 days of deployment in flowing tap water and recalibrate the sensor to remove any drift due to long-term break-in. The accuracy check should be done by carrying out a colorimetric DPD analysis of a sample of the flow cell effluent and comparing it with the latest logged reading or the reading displayed in a real-time or 6500 study. Note that the sonde should not be taken off-line to calibrate the sensor. Calibration of any parameters during a study will not interrupt the continuity of the Unattended logging file.

- Check the accuracy of the free chlorine sensor every two weeks if possible and recalibrate if necessary.

ATTACHMENT 1. FREE CHLORINE MEMBRANE INSTALLATION INSTRUCTIONS

FREE CHLORINE SENSOR ELECTROLYTE PREPARATION

Open the 6573 membrane kit which was shipped with your 6572 chlorine probe and prepare the electrolyte solution. Dissolve the KCl in the dropper bottle by filling it to the neck with deionized or distilled water and shaking until the solids are fully dissolved. After the KCl is dissolved, wait a few minutes until the solution is free of bubbles.

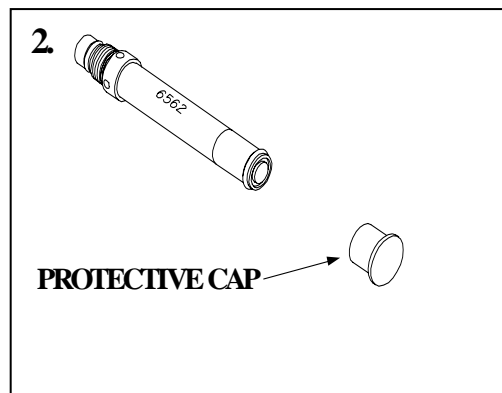
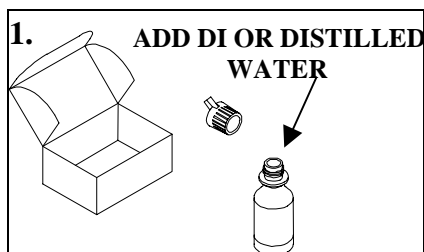

FREE CHLORINE SENSOR MEMBRANE INSTALLATION

Remove the protective Teflon membrane and O-ring from the sensor end of the YSI 6572 Free Chlorine probe. **CAUTION: The Teflon membrane MUST be removed for proper sensor function.**

Remove the protective cap is installed on the connector end of the probe.

Locate the 6035 Reconditioning Kit which was supplied with your 6572 Free Chlorine Probe. Use one of circular sanding disks the 6035 Reconditioning Kit to sand the face of the 6572 Probe according to the following instructions.

- Hold the probe in a vertical position, place a sanding disk under your thumb, and stroke the probe face in a direction parallel to the platinum electrode (located between the two silver electrodes). The motion is similar to that used in striking a match. Usually 10-15 strokes of the sanding disk are sufficient to remove black deposits on the silver electrodes. However, in extreme cases, more sanding may be required to regenerate the original silver surface.
- Rinse the probe tip well with purified water to remove any dust from sanding.

CAUTION: You must sand your free chlorine sensor as described above prior to installing a membrane to insure the surface tension for probe surface/membrane interface.

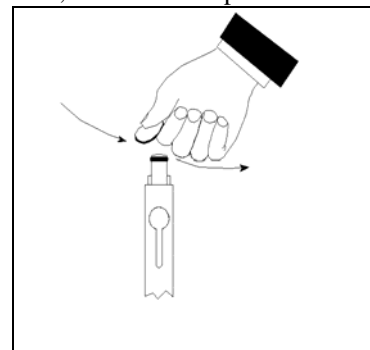

Locate the YSI 6574 O-ring Installation Kit which was shipped with your sonde. Note that the kit contains two items – a circular plate with a threaded hole and a cylindrical tool with a screwdriver-style handle as shown in the picture below.



Thread the nut on the end of the 6572 probe into the base plate as shown in the picture below.



Place an o-ring from the 6573 membrane kit in the groove at the bottom of the tool as shown in the picture below left.

Apply a few drops of KCl solution to the tip of the probe as shown in the picture below right. The fluid should completely fill the small moat around the electrodes and form a meniscus on the tip of the sensor.

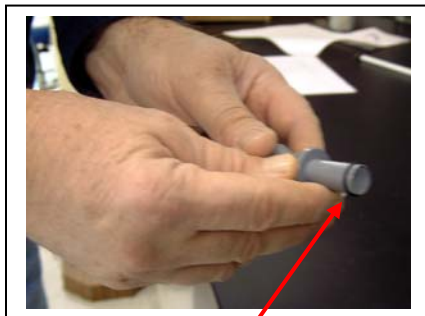

O-Ring in Groove

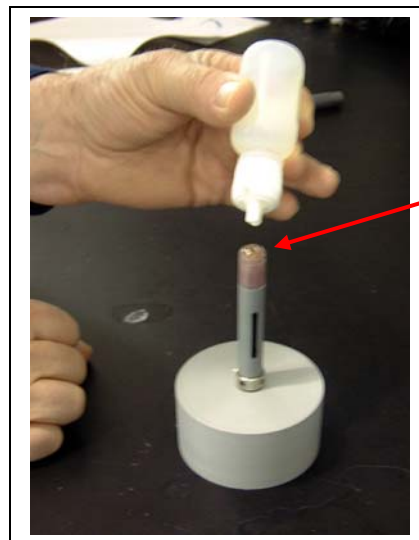

Meniscus

Remove a white membrane sheet from the package in the 6573 membrane kit as shown in the picture below.

CAUTION: The blue sheets are simply protective spacers and CANNOT be used as membranes for the free chlorine sensor.



White Membrane

As shown in the pictures below, lay the membrane on the probe tip that contains the electrolyte so that the probe tip is approximately in the middle of the membrane.

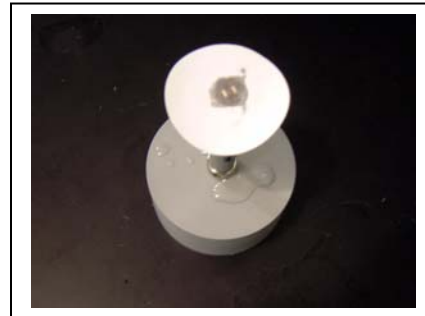

As shown in the picture below, place the bottom of the o-ring installation tool over membrane/probe face and press down securely.

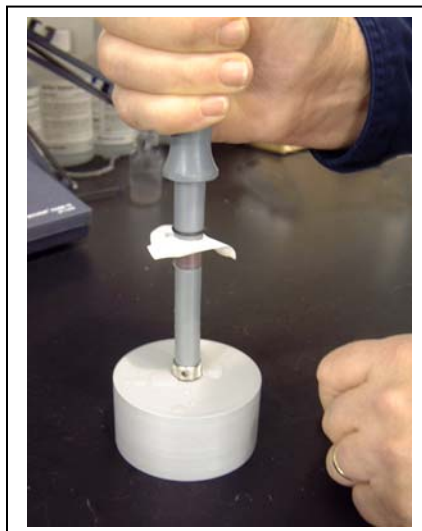

As shown in the picture below left, roll the o-ring off of the end of the installation tool so that it resides in the o-ring groove of the probe. Be sure to hold onto the O-ring prior to removing the installation tool so that it does not pop out of the groove. Then, as shown below right, remove the installation tool and make certain that the o-ring is centered in the groove on probe end.



As shown in the picture below, use a razor blade or knife to trim away the excess membrane material.



The pictures below show a properly installed free chlorine membrane. Note that, because the membrane will not stretch, there may be some points where the membrane is slightly “bunched up” in the o-ring groove. This effect is normal and will not affect sensor function. Also note that the presence of bubbles under the membrane is also normal and should not affect probe function.

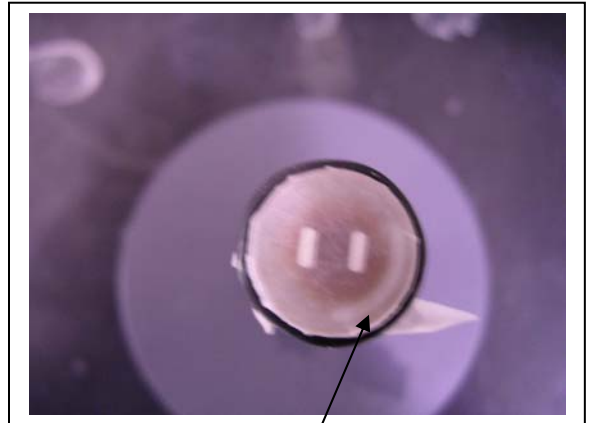

Note the presence of a bubble after installation. This is acceptable for a free chlorine membrane.

After installing the membrane, either proceed immediately to the sensor activation protocol described above in the Quick Start Guide or store the probe in a beaker of tap water (NOT deionized or distilled water) as shown in the picture below to prevent drying out. Be sure to place the probe GENTLY into the beaker to avoid damaging the membrane integrity.



NOTE CAREFULLY: Users who are accustomed to installing a Teflon membrane on a YSI dissolved oxygen sensor should note that the methods recommended for the Teflon installation are not likely to work well for the free chlorine membrane because this membrane cannot be stretched. Therefore, dissolved oxygen membrane installation techniques which are outline in the manuals for various YSI instruments, including standard 6-series sondes utilizing the 6562 Rapid Pulse DO sensor, are NOT RECOMMENDED for the free chlorine membrane installation.

Detailed instructions for the following operations are provided in the noted sections of the manual which you received with your 6500 Process Monitor:

- Supplying power to the 6500 (Section 2.5.2)
- Connecting the sonde to the 6500 (Section 2.5.1)
- Configuring the 4-20 mA current loops to the existing sensors (Section 3.3.4)
- Interfacing the current loop or modbus output of the sonde to your SCADA system (Section 2.5.3)
- Using the 6500 software to set up your sonde, calibrate sensors, and customize the display (Section 3.2)

This appendix to the Drinking Water Sondes Manual is designed as a “Quick Start” guide to common operations involved in using your DW sonde with a 6500 and is also designed to be used as a “check list” for this application. In addition, this appendix explains in detail the “Sample and Hold” feature of the DW sonde software which has been designed specifically for applications in which the DW sonde is interfaced to a 6500. Please refer to the following schematic diagram for many of the operations described below:

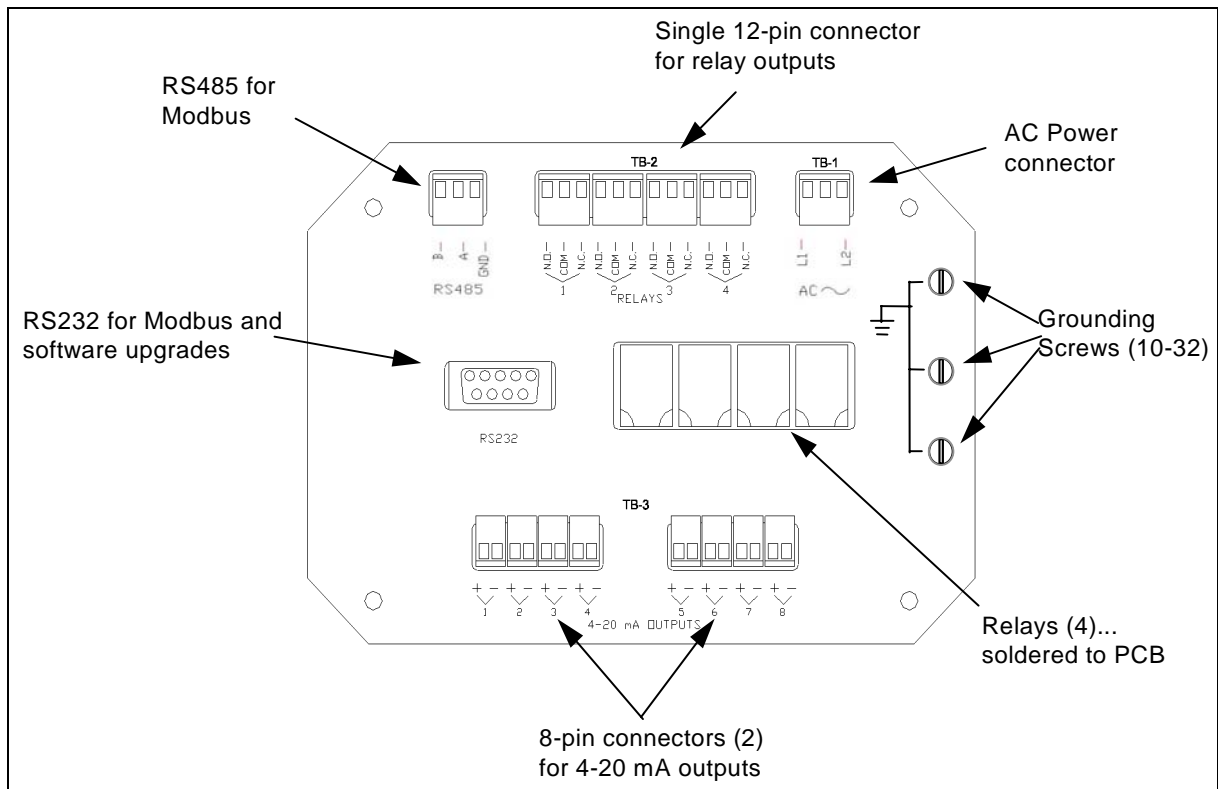

Select a Location for the Drinking Water Sonde and the 6500 Process Monitor. The sonde should be located as close as possible to a water tap and a drain to minimize the tubing required. The 6500 should also be located as close as possible to the sonde to minimize cable cost and must be within 250 feet (75 m) in order to assure proper communication between the sonde and the 6500.

Mount the 6500 to a Wall. Attach the two mounting brackets supplied with the 6500 to the back of the monitor as shown in the picture below left. Then attach the monitor to the wall with screws as shown in the picture below left. Use anchors if necessary.

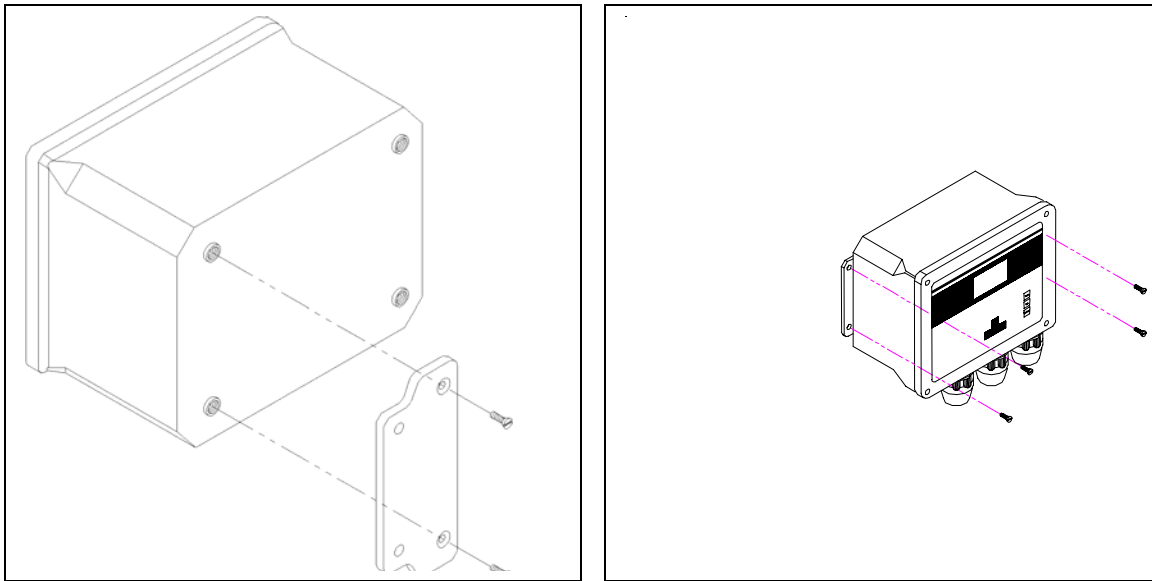

Mount the DW Sonde at the Monitoring Site. There is no right or wrong way to mount the sonde at the deployment sites. One typical method is to simply set the sonde on a bench or other flat surface near the water inlet and drain. If a relatively large sink is present at the monitoring site, then the sonde can simply be placed upright directly in the basin with the effluent hose discharging directly into the sink drain. To prevent the sonde being inadvertently knocked over the sonde can be strapped with “bungee” cords or other retainers. For other locations it may be best to hang the sonde by its bail from a hook on a wall or frame. See the picture below a typical sonde installation.



Set Up the Wiring for 4-20 mA Current or Modbus Output to Your SCADA System. As described in Section 2.5.3 of the 6500 manual, the 6500 has the ability to output up to eight current output signals, each corresponding to a water quality parameter. These connections for these outputs are made on TB-3 which can be found at the bottom of the 6500 once the cover has been removed.

Supply Power to your 6500. After removing the front cover, you will need to have a qualified electrician supply 110-230 volt AC power to your 6500 through TB-1 according to the instructions found in Section 2.5.2 of the 6500 manual. Note that it is best to have a switch which is external from the 6500 in the power circuit so that power can be shut off to the 6500 when removing the front panel. This switch is NOT supplied with the 6500 and should be purchased by your electrician. **CAUTION: The sensitivity and stability of the monitor will be impaired if the input wiring is not grounded. Do NOT apply power to the 6500 until all electrical connections are verified and secure.**

Configure the Current Loop Outputs. As described in Section 3.3.4, you will be required to select which parameters you want to output to your SCADA via the 4-20 mA function and to enter the parameter values which correspond to the 4 mA and 20 mA values for each parameter. To activate the menu section of the 6500 software, press the **Esc** and **Enter** keys simultaneously to display the Main menu as shown below.

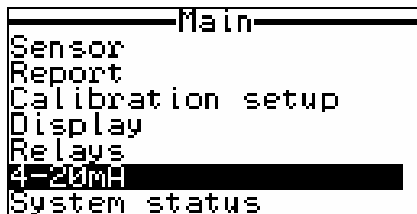

Then highlight the **4-20 mA** entry, press **Enter**, and follow the instructions in Section 3.3.4 of the 6500 manual until all 4-20 mA outputs have been activated and properly configured. Press **Esc** to return to the **Main** menu.

Set Up Your Sonde Configuration and Calibrate Your Sensors. Prior to attaching your DW sonde to the 6500 Monitor, you will need to activate the proper sensors and report parameters, and calibrate all of the sensors EXCEPT free chlorine. The free chlorine sensor will be calibrated at a later time after installation in the flow cell at the site.

CAUTION: Be certain that the free chlorine sensor is NOT present in the sonde bulkhead while calibrating the other sensors (pH, ORP, Conductivity, Turbidity, etc.). Some of the calibration reagents may temporarily bias or damage the free chlorine electrodes which will then require reconditioning.

The setup and calibration processes can be accomplished by two different methods as described below:

- Interface of the 6-Series Sonde with the 6500 Monitor via the matching MS-8 connectors on the sonde cable and the 6500 enclosure. To carry out this procedure, the 6500 Environmental Process Monitor must be installed in its permanent location with AC line power properly installed as described by local electrical codes. See Sections 3 and 4 of the 6500 manual for detailed instructions.
- Interface of the 6-Series Sonde with a laboratory computer or 650 display/logger. If a computer is selected for setup, you must employ a YSI 6095B DB-9 to MS-8 adapter and you will have to power the sonde either through internal batteries or a YSI 6038 or 6651 power supply. After using this method to calibrate the sonde, proceed to section 3.3, 6500 Monitor Setup, in this manual.

Because it is usually more convenient to calibrate the pH, ORP, conductivity, and turbidity sensors near a sink in a laboratory environment, YSI recommends that the second method be used if at all possible. However, if the 6500 is your only interface device, the setup and calibration routines can be carried out using the 6500 software as described in Sections 3.2 and 4.2 of the 6500 Process Monitor manual.

If you choose to use the computer or 650 interface for the calibration protocol and then later interface the calibrated sonde to the 6500, follow the instructions in Sections 2.5 and 2.6 of the manual supplied with your 6920DW or 600DW-B Drinking Water Sonde.

Activate Your Free Chlorine Sensor. After calibration of all other sensors is complete, install a membrane on the free chlorine sensor and activate it according to the detailed instructions found in Sections 2.3 and 2.6.1 of the DW sonde manual. Then store the activated probe in tap water (NOT deionized or distilled water) until it can be installed in the sonde bulkhead. After installation of the free chlorine probe in the sonde, proceed to the next step.

Attach the DW Sonde to the 6500. Interface of the DW sonde to the 6500 Process Monitor will require a YSI field cable with a model number 609X, where the X defines the cable length. This cable must be purchased separately. Attach the silver threaded end of the cable to the sonde by engaging the keys in the mating connectors and then turning the nut clockwise until fully engaged. Then attach the other end of the cable (MS-8 connector) to the corresponding connector on the bottom of the 6500. To make the connection, place the cable MS-8 connector over that of the 6500 and rotate the field cable connector until engagement occurs. Then rotate the field cable connector approximately 1-quarter turn until it is fully engaged as evidenced by a “click”.

Observe Sonde Readings in Real-Time on the 6500 Display. After attaching the sonde to the 6500, you will hear a beep indicating proper interface and then sensor readings will appear on the display of the monitor. To configure the display with regard to contrast, number of parameter lines, etc., press the **Esc** and **Enter** keys simultaneously to display the menu associated with the 6500 software as shown below.

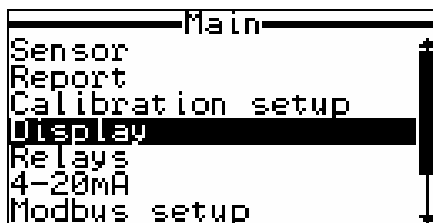

Choose the **Display** selection and press **Enter**. Then follow the instructions in Section 3.3.2 of the 6500 manual to configure the 6500 display. When finished, press **Esc** until the sensor readings are again displayed on the screen.

Calibrate Your Free Chlorine Sensor. After the probe has been installed, immediately attach the flow cell to the sonde, attach appropriate hoses to the inlet and outlet of the flow cell and start a flow of water at a rate of 500-1000 mL/minute (minimum 500 mL/min). Observe the free chlorine readings on the 6500 display and, when stable, collect an effluent sample from the flow cell and perform a DPD colorimetric analysis using a test kit to determine the actual free chlorine concentration. Then immediately use the Calibration function of the 6500 to calibrate the sensor to the DPD value as described in Section 4.2 of the 6500 manual. Note that the stabilization of the free chlorine sensor after activation may require 1-2 hours in flowing tap water after connection of the sonde to the 6500.

Activate the “Sample and Hold Function” and Select Your Sample Interval. The new DW sonde software which is supplied in your instrument includes a new feature designated “Sample and Hold”. Basically, when “Sample and Hold” is active, the 6500 display and the SCADA output of the 6500 becomes equivalent to the internal memory of the sonde while an Unattended study is running. In the Unattended mode, the sonde “sleeps” between periodic samples with the interval between samples defined by the user. This method of operation results the extension of both the sonde battery life (not important in 6500 applications) and the time between required sensor maintenance procedures (which is important to 6500 drinking water applications).

While data can be output continuously to the 6500 (and to the SCADA), YSI strongly recommends the use of the “Sample and Hold” feature of the system which outputs data to the 6500 (and the SCADA) at a user selected interval with the sensors “turned off” between readings. There are two reasons for this strong recommendation:

1. Because of the hydrophilic nature of the chlorine sensor membrane, cross-talk between the chlorine sensor electrodes and the pH sensor can occur. If cross-talk is present, it is likely to reduce the life of the pH sensor if it is run in the continuous mode.
2. The oxidation of the anode of the free chlorine sensor is the factor which normally dictates maintenance on the sensor and the extent of the oxidation is proportional to the time the sensor is polarized. Thus, if the sensor is only polarized for 20 % of the time, the time between sensor reconditioning will be extended by approximately a factor of five.

The only disadvantage of the “Sample and Hold” feature is that the data output to the 6500/SCADA from all sensors is “frozen” for the sample interval. Thus, if a study were begun at 10:00 at a 5 minute interval, the sensor readings shown by the 6500 (and output to the SCADA) which were taken at 10:00 would remain the same (even though they might be changing slightly) until 10:05, when new sensor readings would be output. These readings, in turn, would be frozen until 10:10, when the next readings would be sent to the 6500.

The “Sample and Hold” feature can be activated in the **Advanced|Setup** menu of the sonde software while attached to a PC or a 650 Display/Logger or can be activated directly from the **Setup sonde** menu of the 6500.

NOTE CAREFULLY: If the Sample and Hold feature is activated from a PC or 650 and then the sonde is attached to a 6500, no interface will occur until the first point is taken using the Sample and Hold mode. At the time the first point is taken, correct interface with the 6500 will take place and readings will be visible on the 6500 display. For example, if a sonde is put into Sample and Hold mode with a 15 minute interval at 15:05 and then immediately attached to a 6500, readings will not be visible on the 6500 display until 15:15, i.e. the time of the next reading in the Sample and Hold mode.

If activating the feature directly from the 6500, press the **Esc** and **Enter** keys simultaneously to activate the Main menu of the 6500 and highlight the **Setup sonde** selection and press **Enter**. Then highlight the **Sample and Hold** entry and press **Enter** to activate the feature as evidenced by a checkmark in the box. After activating the **Sample and Hold** feature, you will also be required to enter a time interval between samples during which time the 6500 display and 4-20 mA and Modbus outputs will be frozen. Use the right/left arrow keys on the 6500 to move to the proper digits and then the up/down arrow keys to input the proper value. Then press the **Enter** key to confirm your interval selection. Our empirical experience is that most parameter change events in drinking water systems are observed with a 15 minute sample interval (the default value), but, to be sure, you may want to select a 5 minute sample interval in the 6500 System Status menu. Sample intervals of less than 5 minutes are not recommended when using your DW sonde with a 6500 in long term monitoring studies.

Under most conditions, it is best to calibrate all sensors except free chlorine with the **Sample and Hold** feature INACTIVE and then activate the feature just prior to logging to the start of a study which is sending data to a SCADA system and the internal memory of the sonde at the predefined **Sample and Hold interval**. However, it is acceptable to calibrate any parameters with an ACTIVE **Sample and Hold** feature as long as a certain precaution is followed. This precaution involves making certain that the sonde has been in the flow cell and connected to a 6500 for at least one Sample and Hold interval prior to implementing a calibration from the 6500 keypad. Thus, if the **Sample and Hold interval** is 15 minutes and the sonde was attached to the 6500 at 15:00, you should wait until the 15:15 reading appears on the 6500 display prior to calibrating any sensor with the **Sample and Hold** feature active. As noted above, in any case, you should wait for 1-2 hours, i.e. several Sample and Hold intervals, before calibrating the free chlorine sensor whether or not the Sample and Hold feature is active.

NOTE CAREFULLY: FAILURE TO WAIT AT LEAST ONE SAMPLE AND HOLD INTERVAL PRIOR TO CALIBRATING WITH THE SAMPLE AND HOLD FEATURE ACTIVE IS LIKELY TO RESULT IN ERRONEOUS CALIBRATIONS. AS NOTED ABOVE, IT IS BEST TO CALIBRATE ALL SENSORS EXCEPT FREE CHLORINE WITH THE SAMPLE AND HOLD FEATURE INACTIVE AND THEN CALIBRATE FREE CHLORINE AT A LATER TIME.

Carry Out Spot Checks of Accuracy and Recalibrate as Necessary. You should confirm the accuracy of your free chlorine readings relative to a DPD colorimetric analysis within one week of your deployment and as often as possible thereafter. Although YSI's extensive empirical testing program has indicated that the sensor is capable of remaining within the accuracy specification for 60-90 days, we cannot guarantee that the sensor will not be susceptible to some drift depending on the content of your drinking water. Therefore, you should go to your deployment site as often as possible, perform a DPD colorimetric test of the flow cell effluent and recalibrate the sensor from the 6500 display if significant drift is evident. If drift in the same direction continues to be observed and/or if the free chlorine readings become jumpy, then you should remove the free chlorine probe from the sonde, recondition it, install a new membrane, and activate the sensor as described in Section 2.6.1 of the Drinking Water Sonde Manual. It is important to remember that the accuracy specification provided for the free chlorine sensor (+/- 15 % of the reading or 0.05 mg/L, whichever is greater) does not include long term drift even though our empirical studies in several water samples show that the specification can be met for up to 60 day deployments. The extent of the drift of your free chlorine sensor will depend on several factors including the species in your particular drinking water and whether the membrane was properly installed.

APPENDIX H

FREQUENTLY ASKED QUESTION ABOUT YSI DRINKING WATER SYSTEMS

GENERAL

What are YSI Drinking Water (DW) Sondes designed to do?

YSI DW sondes are specially designed for the monitoring of long term trends in drinking water distribution systems in flow cell (slipstream or side stream) applications. Typically, “long term” would mean deployments of at least 60 days with no maintenance of the sensors except for the possible need for in situ calibrations without removing the sonde from the site.

What types of DW sondes are available?

Two types of sondes (shown in the picture below) can be purchased for drinking water applications -- the 6920DW which operates from 8 internal AA batteries and the 600DW-B which operates 4 internal AA batteries.

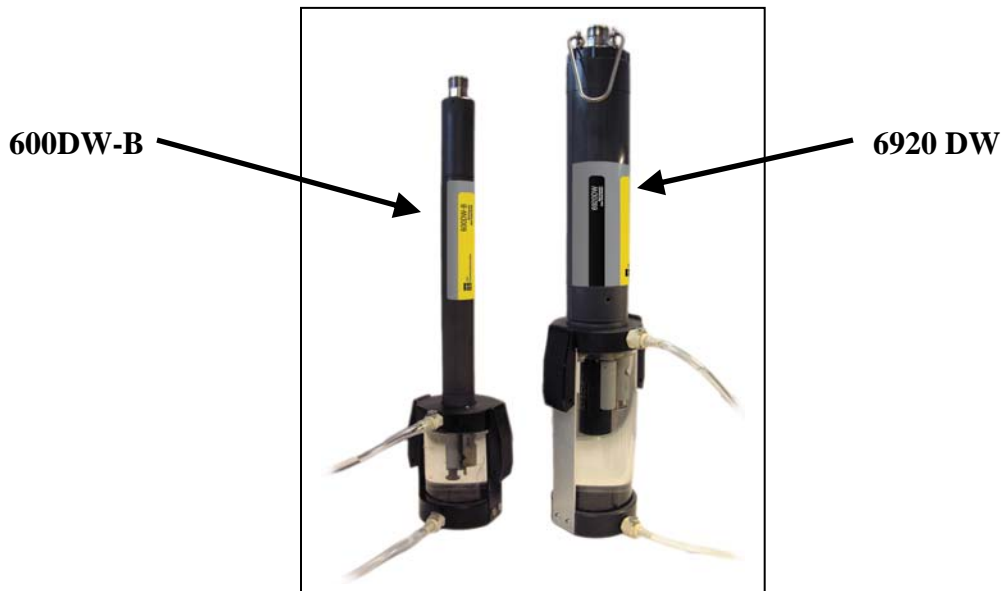

What drinking water parameters can be monitored with DW sondes?

For the 6920DW, typical parameters to be monitored are temperature, conductivity or specific conductance, pH, ORP, turbidity, and free chlorine. The 600DW-B measures all of these parameters except for turbidity. The 6920DW is also capable of measuring ammonium, nitrate, and chloride with ion selective

electrode (ISE) sensors, but their use is not recommended for long term monitoring in flow cell applications due to the potential for large drift. In addition, the 6920DW can measure either Rhodamine WT or chlorophyll INSTEAD OF turbidity, but these analytes are not expected to be important for most drinking water applications. Potential users should note carefully that the DW sondes will NOT MEASURE DISSOLVED OXYGEN as explained in the next section.

What are the differences between YSI DW instruments and YSI 6-series sondes which have been sold for surface- and ground-water applications over the last 13 years?

Other than the sonde overlay which indicates the sonde is a “DW” (600DW-B or 6920DW) version, the appearance and mechanical design of the two drinking water instruments is identical to their surface-and ground-water equivalents (600XLM and 6920). However, the most critical unique feature of the DW sondes is the fact that they contain a different internal PC board which supports the free chlorine sensor, but not a dissolved oxygen sensor. Because of this new hardware which reflects the different polarizing potentials necessary for oxygen and chlorine, DW sondes are not capable of measuring oxygen even though a YSI 6562 oxygen probe would be physically compatible with installation in the DW sondes.

Can I measure dissolved oxygen with a DW sonde if I have a YSI 6562 Rapid Pulse DO Probe?

No. Even though the probe will fit in the sonde bulkhead, the polarizing potential from the free chlorine PC board will not reduce oxygen.

How can I tell the difference between dissolved oxygen and free chlorine sensors?

Along with a different model number stamped on the probe body, the oxygen sensor is built with a gray body while the free chlorine sensor has a white body.

What are the key competitive features of the YSI Drinking Water Sondes?

- Use hardware, software and sensors (with the exception of free chlorine) which have been proven in 13 years of surface- and ground-water usage.
- New free chlorine sensor which is easy to calibrate and which has been proven in extensive flow cell field testing prior to release.
- Relatively small size allows use at virtually any site with a water tap and a drain.
- Easy setup of sonde configuration and calibration of sensors using standard reagents and techniques.
- Data is compatible with YSI’s widely-used EcoWatch for Windows software for use in custom data reports and plots.
- Relatively inexpensive compared to wall-mounted systems utilizing separate sensors.
- Can be deployed at remote locations where no AC power is present.
- Good battery life (30 days at a 15 minute sample interval for both 6920DW (with turbidity active) and for the 600DW-B) under stand-alone conditions.
- Can be used in four distinct modes, all of which have potential use in the drinking water industry.

- Stand-alone with internal logging and battery or external power
- Attached to a PC with real-time graphic display of data using YSI EcoWatch for Windows software.
- Attached to a SCADA system utilizing the YSI 6500 Process Monitor as a link between the sonde and the SCADA.
- Attached to a data collection platform, such as the YSI EcoNet system, which provides web-based access to real-time data.

DRINKING WATER SONDE DEPLOYMENTS

What are the site requirements for using YSI Drinking Water Sondes?

To carry out side-stream (flow cell) studies, you will need the following:

- A water tap with a valve or regulator to control flow and a fitting to allow the attachment of an inlet hose from the tap to the YSI flow cell.
- A drain to collect and dispose of the flow cell effluent
- Hardware to securely mount the sonde. This can be as simple as a hook on the wall to attach to the sonde bail or a horizontal binding strap to attach a floor or table mounted sonde to a wall or a frame.
- A site at which the water inlet and outlet will not freeze under winter conditions.

Do I need to have AC power at the deployment site?

No – the DW sondes can both operate from internal battery power for stand-alone studies in which data is logged to the sonde memory and then uploaded periodically for analysis of previous events. However, if you wish to see your data in real-time through the use of a SCADA system after processing the data via YSI 6500 Process Monitor between the sonde and the SCADA, then AC power will be required at the site. In addition, if you wish to attach the sonde to a DCP (such as the YSI 6200 or YSI EcoNet system), then the use of AC power greatly facilitates the setup. Finally, even for stand-alone deployments, the use of the YSI 6038 or 6651 power supplies saves the internal batteries and therefore is recommended if there is AC power at the site.

I would like to install a drinking water monitoring device directly into a pipe and avoid the need for a drain line? Can I do this with the YSI Drinking Water Sondes?

At the present time, there is no mechanism to insert standard YSI Drinking Water Sondes into a pressurized water distribution system. Depending on market requirements, this type of application might be supported in the future, but, for now, the answer is “No”.

I would like to install a drinking water sonde in my water storage tank by simply suspending it from a support into the tank? Can I do this with the YSI Drinking Water Sondes?

The sondes and sensors were not designed for this application, but might still provide valuable information under these conditions as long as a limitation with regard to the free chlorine sensor is recognized by the user. This limitation is that the free chlorine sensor is NOT flow independent (see below for more information). The flow dependence is not an issue in side-stream (flow cell) applications where the flow is

greater than 500 mL per minute and is relatively constant. However, the varying flow conditions which exist directly in water storage tanks (from completely stagnant to significant flow during filling and emptying operations) will result in significant inaccuracies in the free chlorine data. These errors could be up to 30 % of the reading depending on the time of calibration, in addition to the +/- 0.15 mg/L accuracy specification associated with the sensor when used in flowing water. In addition, if the chlorine content of the tank is stratified, obtaining a representative sample for calibration may also be difficult and would result in an additional error component. Users with tank applications should be prepared for levels of error significantly higher than those specified for flow cell applications if they suspend their drinking water sondes directly in storage tanks.

INTERFACING TO YSI DRINKING WATER SONDES

What modes of operation can be used with the YSI Drinking Water Sondes?

As described below, the YSI DW sondes are designed to operate in a variety of modes while acquiring long term continuous data.

- **Stand-alone** – In this mode the sonde is set up and calibrated off line (except for free chlorine, see below) and then installed at the site in the appropriate flow cell with the sonde powered by internal batteries. An Unattended study is then begun at a suitable interval (usually 5-15 minutes) and data is logged to internal memory for the length of the study. The data can be uploaded periodically for after-the-fact viewing using either a PC or a YSI 650 Display/Logger.
- **Attached to a PC for Real-Time Graphic Data Display** – In this mode, after calibration the sonde is attached to a PC which is powered externally and has had the YSI software EcoWatch for Windows installed. Using EcoWatch, a real-time study is begun with data logged automatically to the hard drive of the PC at the desired interval as well as displayed graphically on the monitor of the computer in real-time.
- **Attached to a YSI Process Monitor for Use with SCADA Systems** – In this mode, the sonde is placed in the flow cell and then attached to the 6500 which is AC powered at the site. The data from the sonde sensors are automatically displayed on the screen of the 6500 for real-time viewing in non-graphical form. The sensor signals can also be converted by the 6500 hardware/software into either 4-20 mA or Modbus protocols for interface to a SCADA system. **While data can be output continuously to the 6500 (and to the SCADA), YSI strongly recommends the use of the “Sample and Hold” feature** of the system which outputs data to the 6500 (and the SCADA) at a user selected interval with the sensors “turned off” between readings. There are two reasons for this strong recommendation:
 1. Because of the hydrophilic nature of the chlorine sensor membrane, cross-talk between the chlorine sensor electrodes and the pH sensor can occur. If cross-talk is present, it is likely to reduce the life of the pH sensor if it is run in the continuous mode.
 2. The oxidation of the anode of the free chlorine sensor is the factor which normally dictates maintenance on the sensor and the extent of the oxidation is proportional to the time the sensor is polarized. Thus, if the sensor is only polarized for 20 % of the time, the time between sensor reconditioning will be extended by approximately a factor of five.

The only disadvantage of the “Sample and Hold” feature is that the data output to the 6500/SCADA from all sensors is “frozen” for the sample interval. Thus, if a study were begun at 10:00 at a 5 minute interval, the sensor readings shown by the 6500 (and output to the SCADA) which were taken at 10:00 would remain the same (even though they might be changing slightly) until 10:05, when new sensor readings would be output. These readings in turn would be frozen

until 10:10, when the next readings would be sent to the 6500. The “Sample and Hold” feature is explained in more detail in **Appendix G. Using Your Drinking Water Sonde with a YSI 6500 Process Monitor.**

- **Attached to a Data Collection Platform (DCP)** – In the absence of a SCADA system, the sondes can be attached to DCPs such as the YSI EcoNet system and the YSI 6200 to allow access to the data via modem communication. For the 6200, the YSI software package EcoWatch DCP is used and data can be transferred directly to your computer via a land-line or cellular modem or, for short distances, via spread spectrum radio. For the EcoNet system, data is transferred via modem to third party server where it can be accessed by the user via a simple Internet link.

What type of cable will I need for setting up and deploying the drinking water sondes?

Depending on your applications, two types of YSI cables can be used with your DW sondes:

- **6067B** -- If your applications involve the stand-alone scenario described above where the instrument is powered on internal batteries and then recovered for data upload, then the relatively-inexpensive 6067B is probably the ideal interface cable to your DW sonde. The cable can be used in the laboratory to set up the instrument for deployments to upload data in the laboratory or in the field to a PC when no provision for a water tight connection is required. Note, however, that you cannot interface between the 650 Display/Logger and a sonde with this cable, so if you will be using the 650 for periodic uploads, you will require a YSI field cable as described below.
- **Standard YSI Field Cables** – If your applications involve the further interface of the DW sonde to a device other than a PC, you will need a YSI field cable in the appropriate length for your conditions. These cables have a YSI Model Number “609X” where the value of “X” determines their length. These cables have a connector on one end which attaches to the sonde and a military-style (MS-8) connector on the other end which will directly interface to a 650 Display/Logger, a 6500 Process Monitor, and 6200 and EcoNet data collection platforms. If you wish to use your field cable for laboratory calibration while interfacing the sonde to a PC, you will require a YSI 6095B adapter which has a mating MS-8 connector at one end and standard serial connector (DB-9) at the other.

What will I need to supply power to my drinking water sondes?

For stand-alone deployments and real-time applications using EcoWatch for Windows, the sondes can be powered using internal batteries where the 6920DW and 600DW-B will have a battery life of about 30 days at a 15 minute sample interval. If AC power is present at the site of the stand-alone deployment, then it is probably prudent to use the YSI 6038 (US and Canada) or the YSI 6651 (all countries) power supplies to provide power. To use these power supplies, you must have a field cable with a 6095B adapter attached to the sonde; the power input from the supplies goes through an MS-4 connector on the 6095B. The power supply will also connect to a 6067B calibration cable.

For applications involving the YSI 6500 or any data collection platforms, the sonde will automatically be powered from the 6500 (attached to AC power) or DCP (attached to either AC or DC power). However, if you are logging back-up data to the sonde memory while also collecting it via the DCP or a SCADA system, you probably will want to have batteries in the sonde so that data will continue to be collected and stored in internal memory if the power to the 6500 or DCP is interrupted.

FREE CHLORINE MEASUREMENT

What is the chemical formula of “free chlorine”?

When chlorine gas (Cl_2) is added to water, a reaction (called disproportionation) occurs to form hypochlorous acid (HOCl) and hydrochloric acid (HCl). The hypochlorous acid is a strong oxidant and the active species in most drinking water disinfection processes rather than gaseous chlorine (Cl_2). One molecule of HOCl has the same oxidizing capacity as a molecule of Cl_2 . Thus, the formula for “free chlorine” is really HOCl rather than Cl_2 . (A portion of the free chlorine will also be in the form of hypochlorite ion OCl^- , with the amount depending on the pH of the sample.) However, convention dictates that free chlorine be reported in units of “mg Cl_2 per liter” even though the active compounds in solution are HOCl and OCl^- . Thus, YSI free chlorine readings are expressed in units of “ Cl_2 mg/L” rather than “ HOCl/OCl^- mg/L” to be consistent with standard reporting convention.

How does the YSI sensor measure free chlorine?

The free chlorine sensor operates on the same amperometric principles as the YSI Rapid Pulse dissolved oxygen sensor which is used in all YSI 6-series sondes designed for surface- and ground-water studies. Basically, the hypochlorous acid (HOCl) and hypochlorite ion (OCl^-) formed when gaseous chlorine is dissolved in water diffuses through a permeable membrane which covers the electrodes of the sensor. The HOCl/OCl^- is then reduced at the cathode of the sensor producing a current which is proportional to the amount of free chlorine present in the solution outside the membrane. As the free chlorine is reduced at the cathode, the silver anode is oxidized to silver chloride (AgCl). The electrochemistry of the chlorine sensor is carried out in a “pulsed mode”, with the cathode polarized for only 1/100 of the time (40 mS) and depolarized for 99/100 of the time (3960 mS) in order to (a) use the existing Rapid Pulse DO circuitry and software, (b) reduce the flow dependence of the free chlorine sensor, and (c) minimize the deposition of AgCl on the anode, the removal of which requires a maintenance protocol. One major difference between the Rapid Pulse oxygen and chlorine sensors is that the reducing and “hold” potentials are set to much more positive values where chlorine is reduced, but oxygen is not. The second major difference is that a hydrophobic Teflon membrane is used to cover the electrodes of the dissolved oxygen sensor while a hydrophilic polyvinylidene fluoride membrane is used with the free chlorine sensor.

Is the extent of the flow dependence reduction from the Rapid Pulse system the same for dissolved oxygen and chlorine?

No. Under continuous pulsing conditions, the Rapid Pulse DO system exhibits a flow dependence of about 3 % while the Free Chlorine system shows a flow dependence of up to 25 %. The greater flow dependence of the chlorine system under the same pulse conditions (40 mS “on”/3960 mS “off”) is likely due to the different diffusion properties exhibited by HOCl with a hydrophilic membrane versus oxygen gas through a hydrophobic membrane. In any case, the flow dependence of the free chlorine sensor is of great enough magnitude that a flow of about 500 mL per minute is required to overcome it under continuous pulsing conditions and hence the requirement for a flow cell for most studies involving Drinking Water sondes with Free Chlorine sensors.

What do the terms “Total Chlorine” and “Combined Chlorine” refer to?

There are two categories of “chlorine” in most treated drinking water – **free chlorine** ($\text{HOCl} + \text{OCl}^-$) and **combined chlorine** which is made up of species formed in the reaction of free chlorine with ammonia which is present in the water. **Combined Chlorine** is thus made up of a general class of compounds called chloramines with formulae such as NH_2Cl , NHCl_2 , and NCl_3 . In water which is treated just with chlorine, there will be a small amount of combined chlorine from the natural ammonia in the water and a large amount of free chlorine; in water which is treated with both free chlorine and ammonia there will be a small

amount of free chlorine and a large amount of combined chlorine. **Total Chlorine** is defined as the **sum of the free and combined chlorine concentrations**.

How are combined and total chlorine measured?

Combined chlorine is usually not measured directly. Instead, the free chlorine is measured by a color-forming chemical test under one set of conditions and the total chlorine is measured colorimetrically under a slightly different set of conditions. Since $\text{Total Chlorine} = \text{Free Chlorine} + \text{Combined Chlorine}$, the Combined Chlorine is calculated as the difference between the Total and Free Chlorine values.

Can the YSI Free Chlorine Sensor measure Total Chlorine?

No. It is very important to be aware of the fact that the YSI 6572 free chlorine sensor and its electronics measure only free chlorine – the sensor is unresponsive to combined chlorine (chloramines). This makes the sensor of questionable utility for measuring “chlorine” in distribution systems which use ammonia as part of the treatment process and thus have predominantly combined chlorine in their drinking water.

Can the YSI Free Chlorine Sensor function in water with high pH?

Yes, unless the pH is much higher than normal for most drinking water sites. From empirical testing, it appears that the YSI free chlorine sensor is less sensitive to OCl^- than it is to HOCl and as the pH rises, there is no question that the amount of HOCl relative to OCl^- is reduced significantly. This means that the sensitivity of the sensor to the mixture of HOCl and OCl^- is reduced at high pH, but the sensor has been shown empirically to have enough overall sensitivity to be functional at pH values up to ca. 9.3 and data to support this claim is available on request from YSI. Note, however, that at pH values above 8.8, there is a possibility that calibration errors can occur. If you see these errors, contact YSI Technical Support for advice on whether to override them.)

The YSI philosophy relative to the use of the free chlorine sensor at high pH is to calibrate the sensor under these conditions of reduced sensitivity in the high pH water and then assume that minor variations in pH during the monitoring study will have only a minimal effect on accuracy. This philosophy has been adopted rather than compensating for changes in pH using the on-board pH sensor in the sonde. It was decided not to do pH compensation because chlorine is usually the most important parameter to the drinking water industry and the accuracy of this parameter would be grossly compromised if a pH sensor failed while providing compensation data during long term monitoring studies. In other words, we feel that the risk of pH probe failure or significant drift is more likely to be a problem to users than the smaller inaccuracies in the uncompensated pH data which might result from small changes in pH. Note that the quoted accuracy specification for water which has a pH of greater than 8.5 is only valid if the pH changes less than 0.3 pH units from the pH at the time of calibration. In addition, users should note that it will not be possible to make free chlorine measurements with the YSI free chlorine sensor under any conditions if the pH exceeds ca. 9.3.

The plot below shows that the chlorine sensor can function well in water of high pH (average of 8.7) as long as it is calibrated versus a DPD analysis in the high pH water. Note that the final QC point which was taken in water at a pH of 7.5 and shows a positive error relative to the DPD analysis since the sensitivity of the sensor to free chlorine had increased significantly as predicted once the sensor was transferred to the lower pH water.

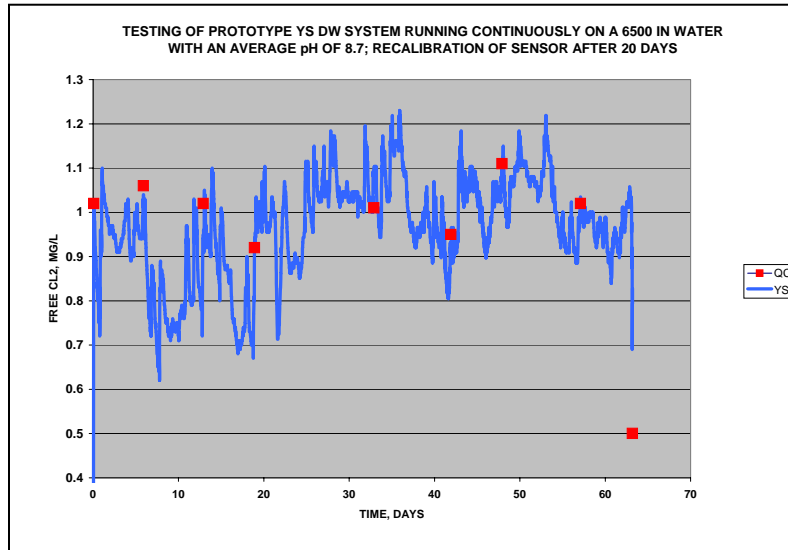

SENSOR CALIBRATION

Is there any difference in the calibration of Drinking Water sonde sensors from standard YSI sondes for surface- or ground-water?

Only for the free chlorine sensor. Sensors other than free chlorine (typically conductivity, pH, ORP, and turbidity) are calibrated in the same way in drinking water sondes as for standard YSI 6-series surface- and ground-water sondes, using the same calibration vessels. As described in the next section, however, the calibration of the free chlorine sensor is somewhat different.

How is the Free Chlorine Sensor Calibrated?

To calibrate the free chlorine sensor, you must make an independent measurement of the free chlorine in the flow cell effluent at the time of calibration. This is usually done by collecting a effluent sample, adding a chemical to it (DPD) which will form a red color which is proportional to the free chlorine in the sample and then determining the intensity of the color using a commercial colorimeter. The analysis is very simple and takes only about 2 minutes to perform. Once the true chlorine value has been determined from the DPD colorimetric analysis, this value is input into the sonde software and the calibration is confirmed.

Where can I obtain the chemicals and colorimeters which are necessary to calibrate the YSI free chlorine sensor?

The YSI 9000 and 9100 Photometers and the version of the Hach Pocket Colorimeter™ II which is specific for free and total chlorine are examples of colorimeters which can be purchased for the analysis of free chlorine in water samples. In addition, you usually will need to purchase the color-forming reagents in either pill or powder form – YSI Item # YAP 001 for the YSI photometers; Hach Item # 21055-69 for the Hach colorimeter. The cost of the reagents is nominal.

Can I just make up a free chlorine standard from commercial bleach and use that to calibrate my free chlorine sensor?

This procedure is not recommended and is likely to result in significant errors in your subsequent readings for three reasons: (1) The concentration of hypochlorite on the bleach bottle is for new bleach batches and may not be correct if the bleach has been on the shelf for varying periods of time; (2) Dilute solutions of hypochlorite may be unstable and change during the calibration procedure; and (3) Because the free chlorine sensor is flow dependent, it needs to be calibrated in water flowing at the same rate as will be used in the continuous monitoring studies. This flow condition is almost impossible to meet by immersing the sensors in stagnant or agitated solutions of bleach. It is important to understand that YSI may not be able to provide customer support for users who do not perform their free chlorine sensor calibrations by the recommended procedure.

Could I measure total chlorine with my colorimeter kit and then calibrate the YSI Free Chlorine sensor to that value?

Subject to additional field trials as described above, you might be able to do this if you know that there is a high percentage of combined chlorine in your water and you are willing to accept qualitative versus quantitative results in terms of accuracy. Remember, however, that, even if the sensor does respond in some way to combined chlorine, you would not really be measuring total or combined chlorine – only a qualitative value for the oxidation capability of the water. In addition, it is likely that you would see calibration errors when using the total chlorine value. Overall, it should be remembered that the YSI sensor is designed to measure **free** chlorine, and, until additional research is performed, any attempts to correlate the sensor output with other parameters is risky.

What accuracy does free chlorine sensor provide?

Immediately after calibration at any value, the sensor should show an accuracy of +/- 15 % of the reading or 0.05 mg/L, whichever is greater, over the specified range of the sensor (0-3 mg/L). Subsequent inaccuracy will be determined by the drift of the sensor, the extent of which can vary with the water being monitored. It is important to remember that the accuracy specification provided for the free chlorine sensor does not include long term drift even though our empirical studies in several water monitoring sites show that the specification can be met in extended deployments as shown in the figures below. Inaccuracy of the sensor from drift (determined from periodic colorimetric analysis) can easily be removed by recalibration of the sensor at the time of quality checks.

Study 1

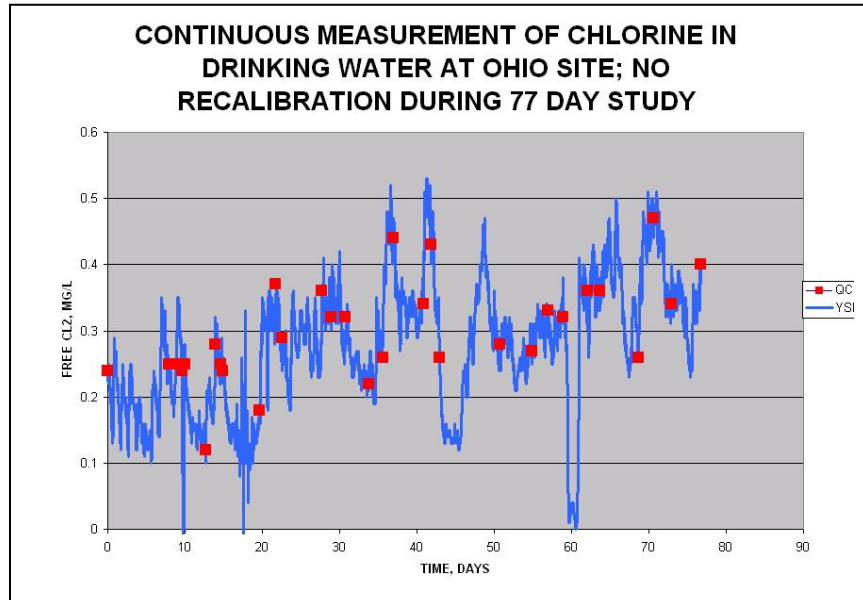

Study 2

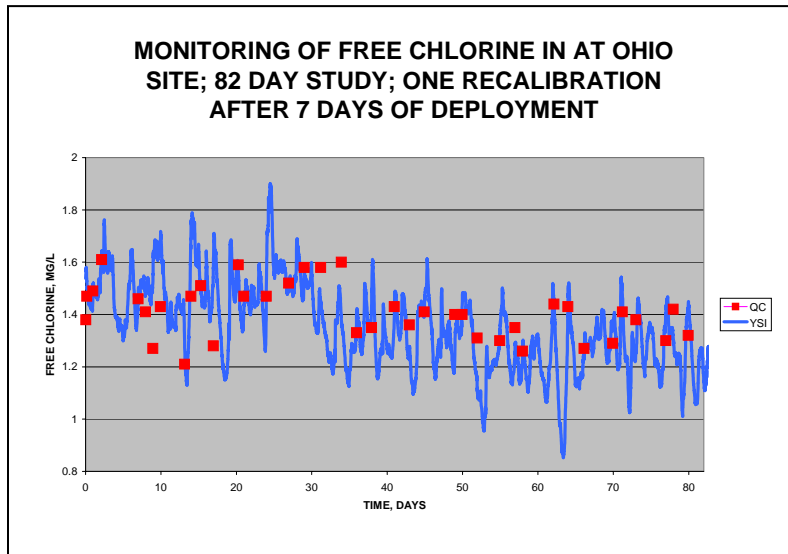

Study 3 – All Data

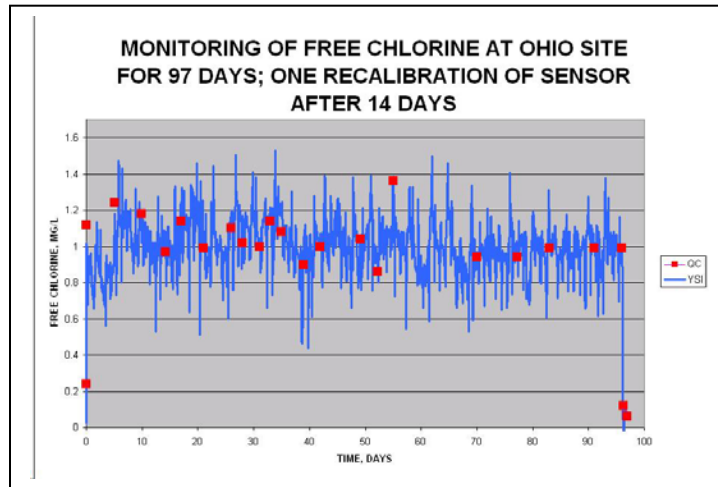

Study 3 Expansion

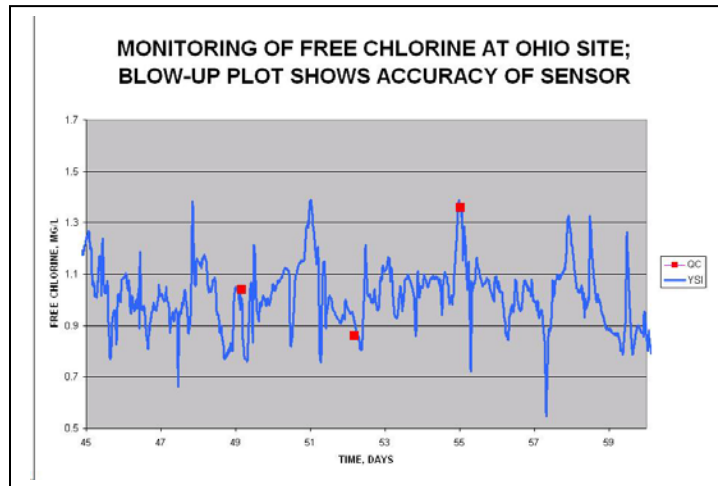

How often should I check the accuracy of and/or recalibrate the free chlorine sensor?

You should confirm the accuracy of your free chlorine readings relative to a DPD colorimetric analysis within one week of your deployment and as often as possible thereafter. Calibration checks involve making a visit to the deployment site, performing a DPD colorimetric test of the flow cell effluent with a handheld, battery-powered colorimeter and recalibrating the sensor if significant drift is evident. It is important to note that because the free chlorine sensor is calibrated *in situ*, i.e., in flowing water in the flow cell, the sonde setup at the site need not be disturbed, making the recalibration procedure very quick and easy. If drift in the same direction continues to be observed, if calibration errors are evident during the calibration process, and/or if the free chlorine readings become jumpy, then you should remove the free chlorine probe from the sonde, recondition it, install a new membrane, and activate the sensor as described in Section 2.6.1 of the Drinking Water Sonde Manual.

How accurate is the colorimetric DPD check of accuracy?

Commercial colorimeters for DPD analysis are very accurate when used properly. However, there can be errors in the determination which result either from user technique or water chemistry. For example, there can be errors in the DPD determination which are caused by dirty cells during the analysis processes of zeroing the instrument or taking a reading. In addition, reagents which are out of date and thus have lost their potency could cause errors. To avoid problems of this nature, always make sure that the colorimeter cell has been wiped clean with lens cleaning paper both prior to taking the zero reading and after addition of reagent prior to taking an actual reading. Also make certain that the reagent pills or packets are within their shelf-life limitation. Since the analysis is so easy to perform, you should always perform repetitive analyses of the flow cell effluent until subsequent readings agree within the specification of the colorimeter – typically 0.05 mg/L.

The DPD analytical procedure for free chlorine is also susceptible to interferences from any oxidizing species other than free chlorine in the water which might oxidize the DPD reagent. If these non-chlorine oxidizing species are present, then they will produce color in addition to that from the free chlorine and this will result in a DPD chlorine value which is erroneously high. Fortunately, the rate of color formation is usually relatively slow compared to that from free chlorine which is effectively instantaneous. Therefore, you can usually determine if extraneous oxidizing species are present in the water sample by reading the color immediately after reagent addition and then again after about 2 minutes. If the value does not change significantly, then the color is likely to be due to free chlorine only; if the reading after 2 minutes is significantly different, then it is likely that other color-forming oxidants are present and the free chlorine reading could be in error.

YSI incorporated



1700/1725 Brannum Lane
Yellow Springs, Ohio 45387 USA
(800) 765-4974 (937) 767-7241
FAX: (937) 767-9320
Website: <http://www.yxi.com>
E-mail: info@ysi.com

Item # 660019
Drawing # A660019
Revision B
June 2006